

INSTRUCTION
ANWEISUNG

取扱説明書
INSTRUCTION

사용설명서

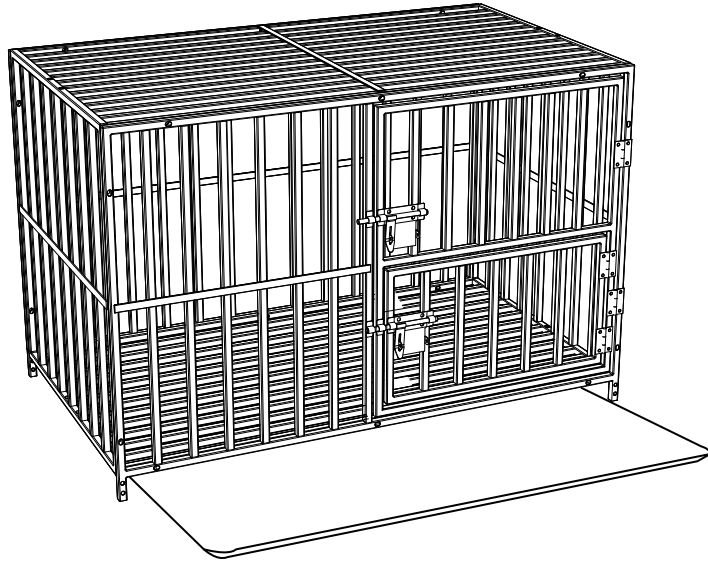

A *1

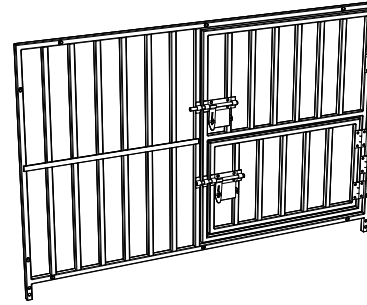

B *2

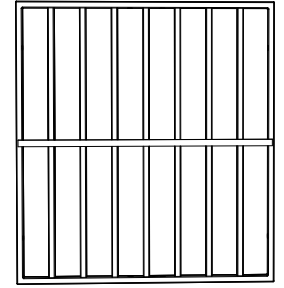

C *1

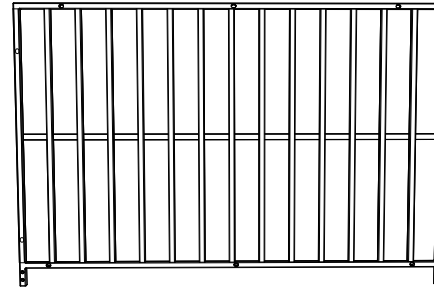

D *1

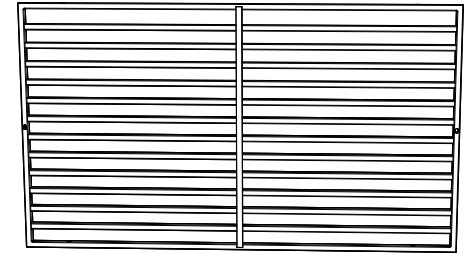

E *1

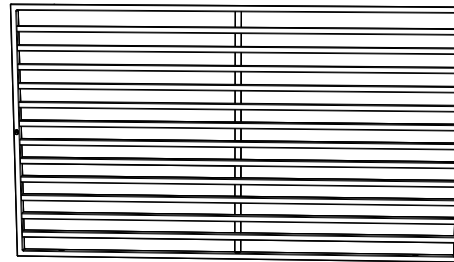

F *1

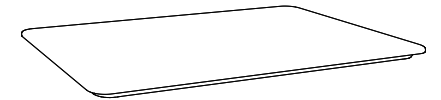

G *24

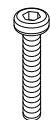

M6*35mm

H *16

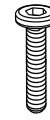

M6*25mm

I *40



M6

J *4

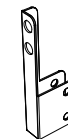

K*1



L *1



EC REP



FR



ÉTUI



FR

UK REP



1

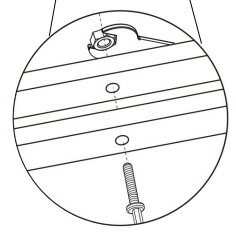
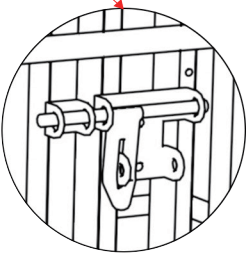
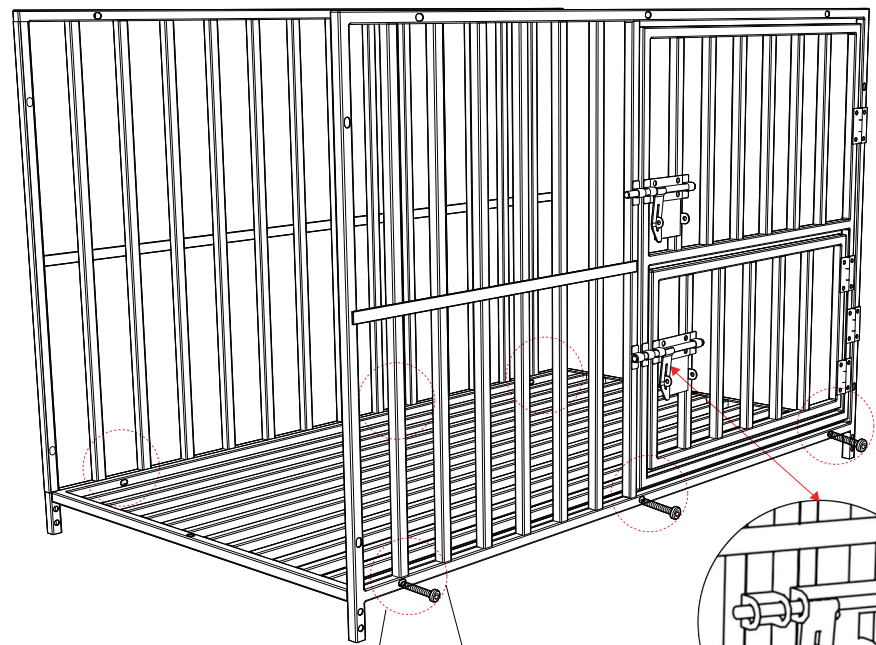
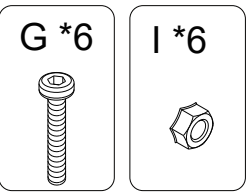

2

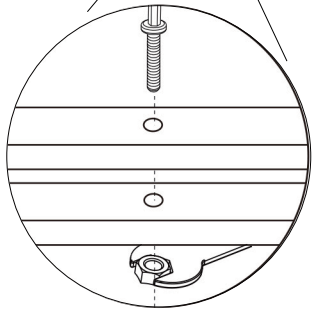
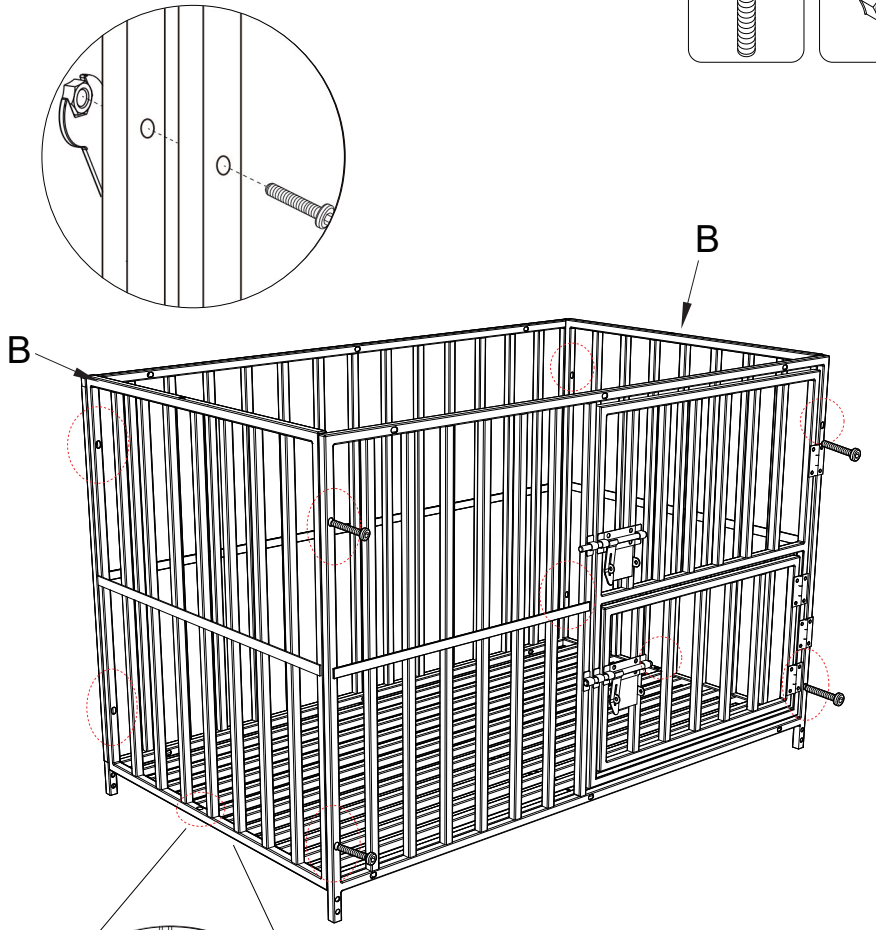
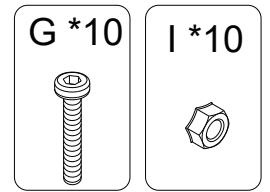

3

G *8

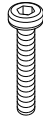

I *8

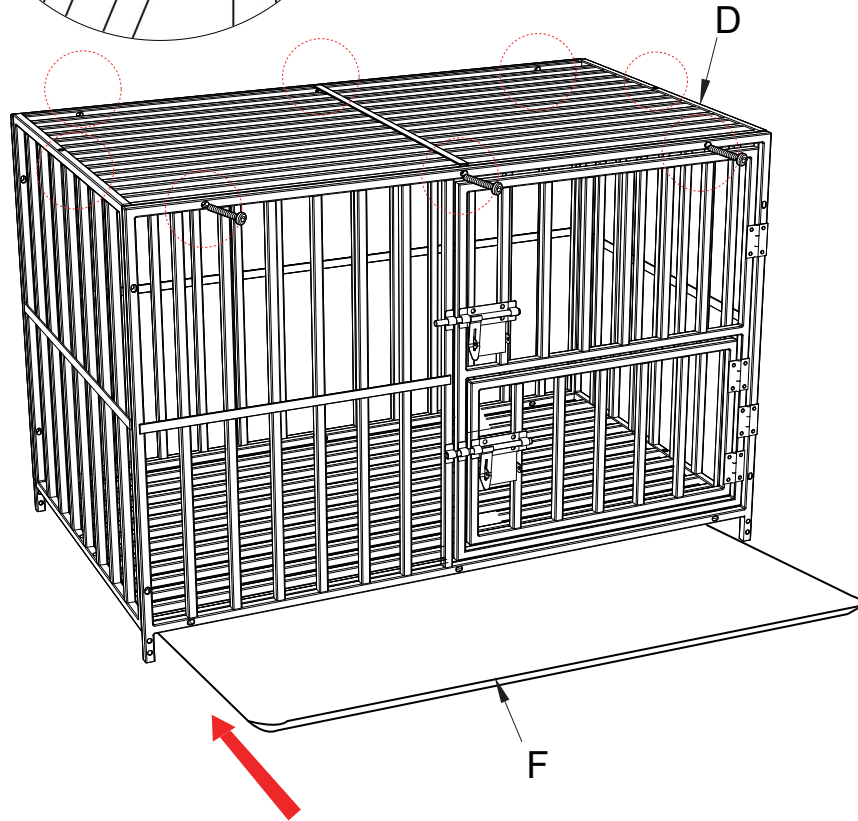
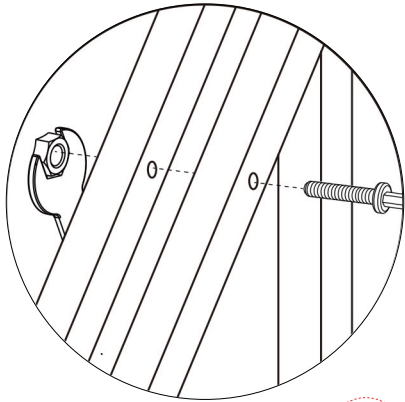

4

H *16

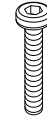

I *16



J *4

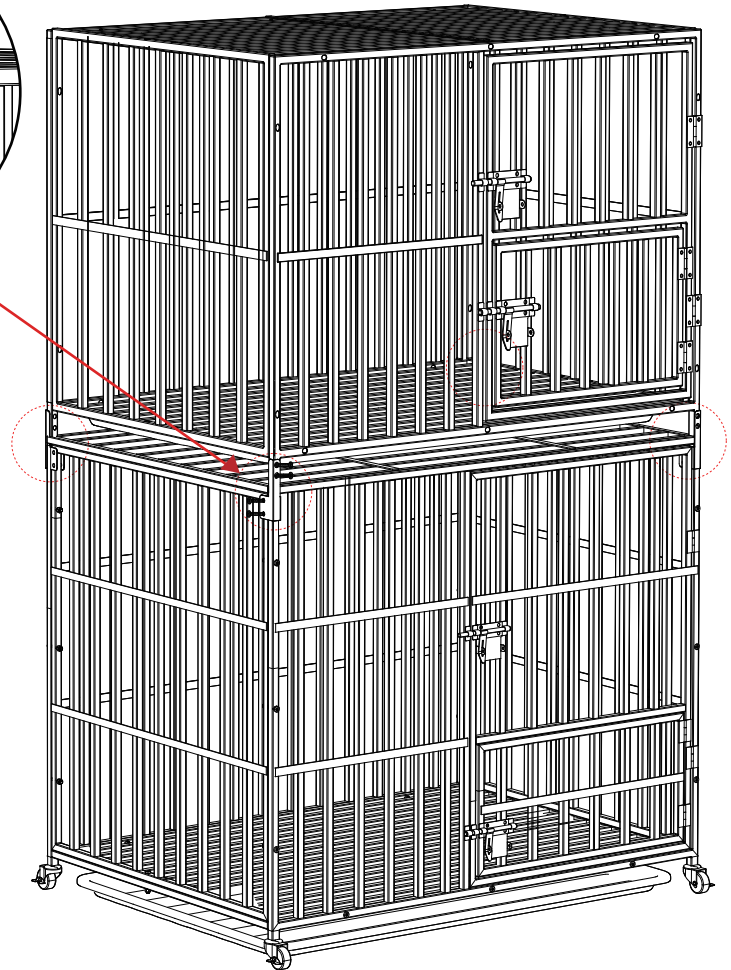
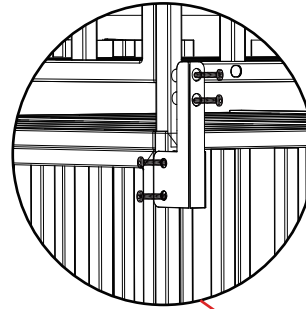

- 1. The cage can be stacked with our another pet cage for use
- 1. Dieses und andere Produkte können nach oben oder unten kombiniert werden.
- 1. この商品は当社の他のペットケージと積み重ねて使用することができますので、詳しくは当社にご連絡してください。
- 1. Comme le montre l'image, ce produit peut être utilisé en combinaison avec un autre produit.
- 1. 그림처럼 이 제품과 다른 제품을 같이 위아래로 조합할 수 있습니다.