

# MOE'S

## Assembly Instructions

WILDER POWER RECLINER



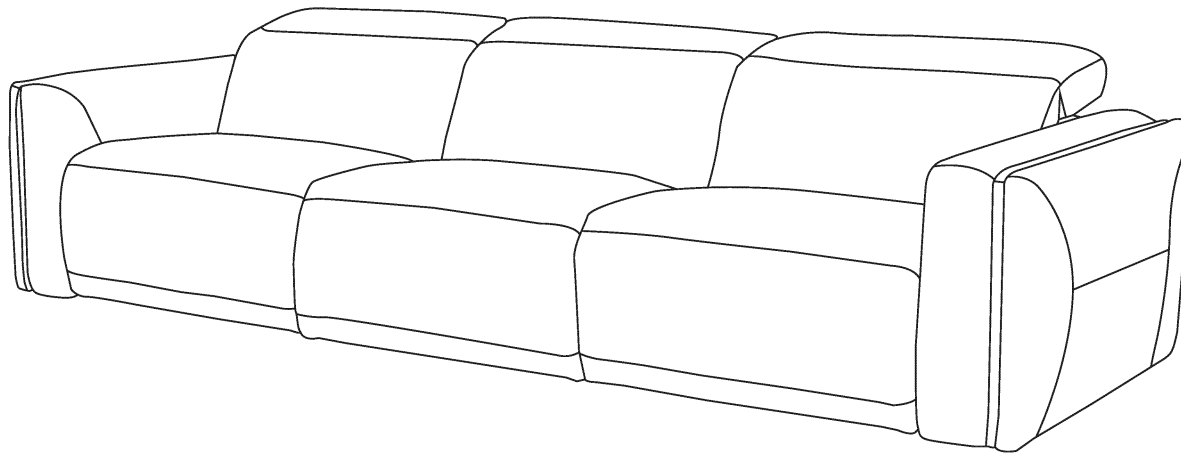

SOFA

KQ-1047



THANK YOU FOR YOUR PURCHASE!

## Parts and Hardware

A	LAF RECLINER	
B	ARMLESS RECLINER	
C	RAF RECLINER	
G	BACKREST FOR LAF/ RAF ARMLESS	 x 3

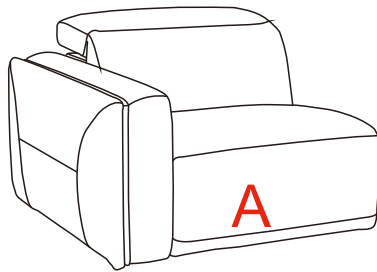

## Notes

Thank you for purchasing this quality product! Be sure to check all packing material carefully for small part that may have come loose inside the carton during shipping.

**CAUTION:** The item is heavy, assembly should be performed by two people.

## Step 1

1. Plug in the power cable and turn on the headrest function.

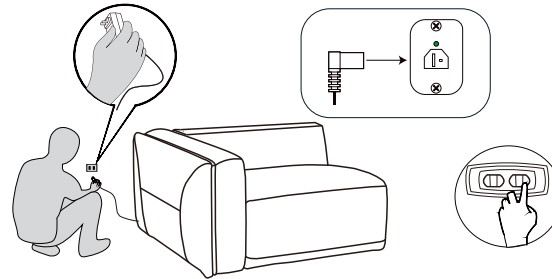

## Step 2

2. First, assemble the sofa back cushion with zipper together.

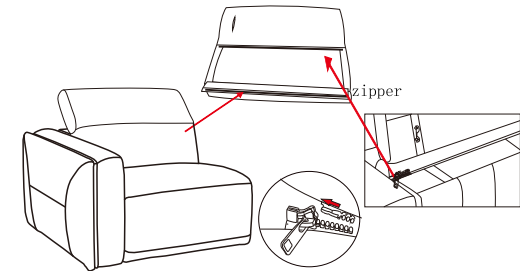

## Step 3

3. Then, connect the sofa's headrest mechanism to the metal parts of the back cushion.

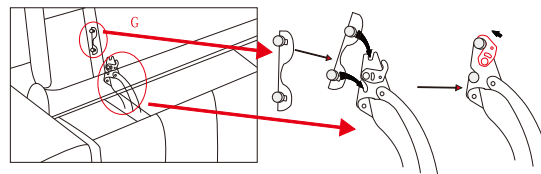



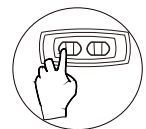
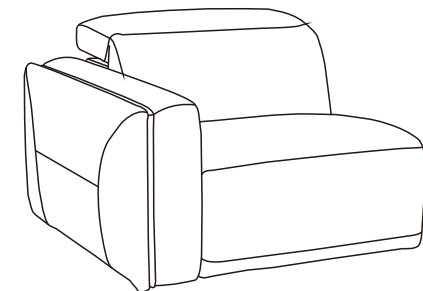

## Step 4

4. Retract the function.



## Parts and Hardware

A	LAF RECLINER	
B	ARMLESS RECLINER	
C	RAF RECLINER	
G	BACKREST FOR LAF/RAF ARMLESS	 x 3

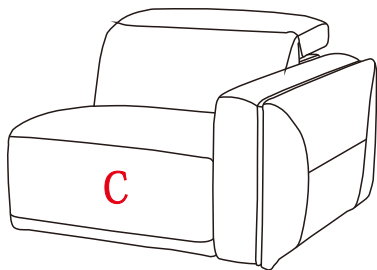

## Notes

Thank you for purchasing this quality product! Be sure to check all packing material carefully for small part that may have come loose inside the carton during shipping.

**CAUTION:** The item is heavy, assembly should be performed by two people.

## Step 1

1. Plug in the power cable and turn on the headrest function.

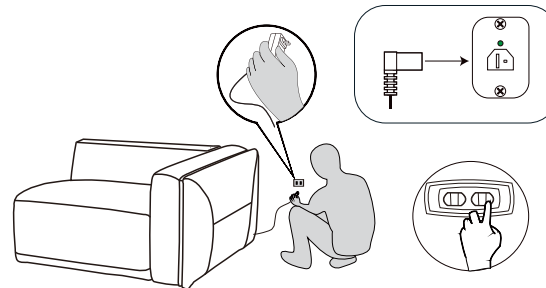

## Step 2

2. First, assemble the sofa back cushion with zipper together.

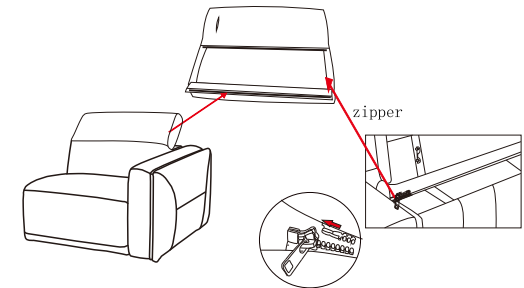

## Step 3

3. Then, connect the sofa's headrest mechanism to the metal parts of the back cushion.

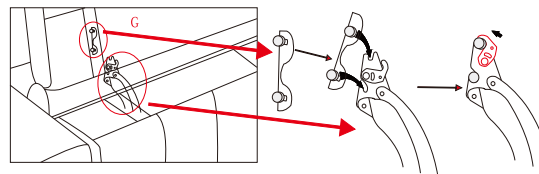



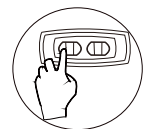
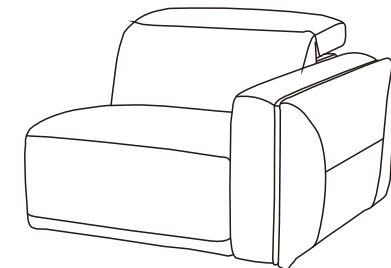

## Step 4

4. Retract the function.



## Parts and Hardware

A	LAF RECLINER	
B	ARMLESS RECLINER	
C	RAF RECLINER	
G	BACKREST FOR LAF/RAF ARMLESS	 x 3

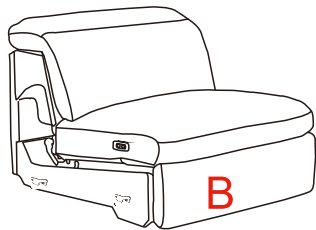

## Notes

Thank you for purchasing this quality product! Be sure to check all packing material carefully for small part that may have come loose inside the carton during shipping.

**CAUTION:** The item is heavy, assembly should be performed by two people.

## Step 1

1. Plug in the power cable and turn on the headrest function.

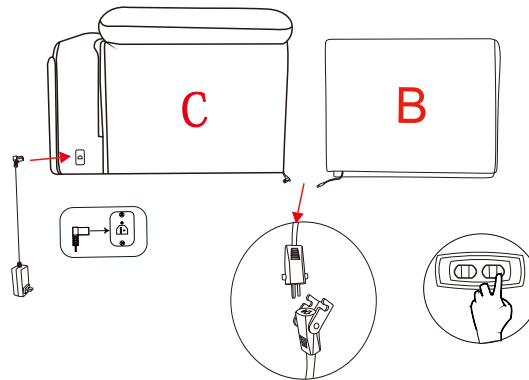

## Step 2

2. First, assemble the sofa back cushion with zipper together.

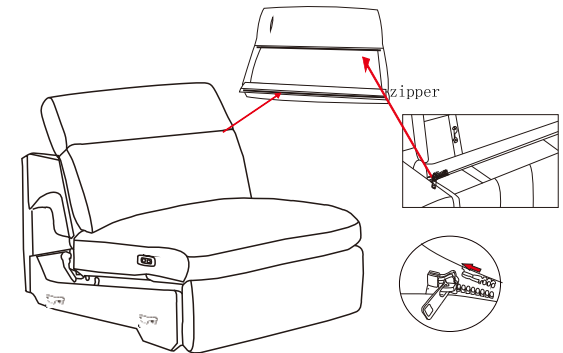

## Step 3

3. Then, connect the sofa's headrest mechanism to the metal parts of the back cushion.

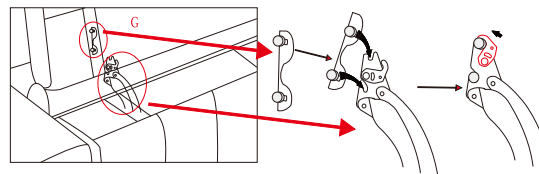

## Step 4

4. Retract the function.

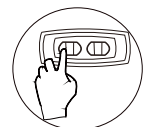
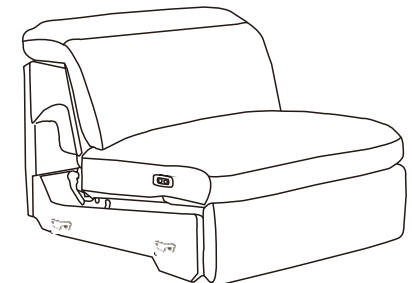

## Parts and Hardware

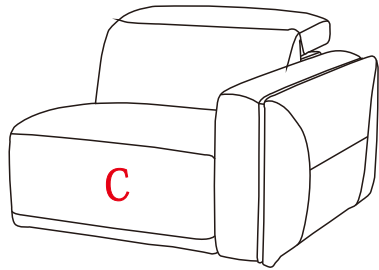
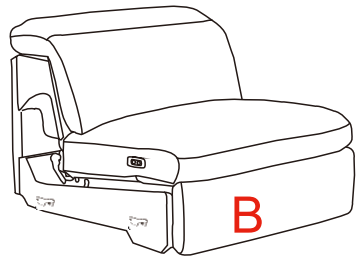
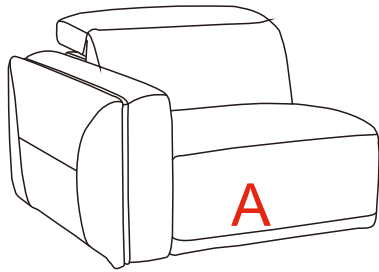

## Notes

Thank you for purchasing this quality product! Be sure to check all packing material carefully for small part that may have come loose inside the carton during shipping.

**CAUTION:** The item is heavy, assembly should be performed by two people.

## Step 1

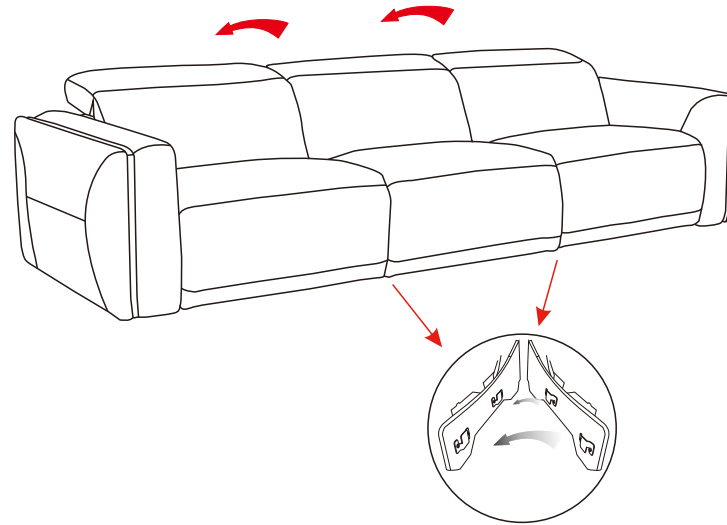

## Step 2

