

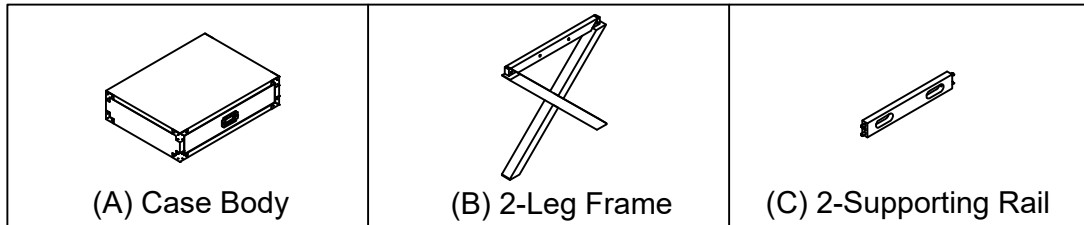





# Assembly Instructions

## CAMPAIGN END TABLE

### PACKAGED



### HARDWARE INCLUDED

 (a)4-Long Bolt	 (b)8-Short Bolt	 (c)12-Spring washer	 (d)8-Flat washer	 (e)4-Curve washer	 (f)1-Allen key
---	--	--	---	--	---

#### Read all instruction before starting assembly:

Remove all contents from the package checking that all of the components listed in "packaged" are included. Prepare a flat protected work surface where the product can be assembled.

#### STEP 1

Upside down (B) 1-Left Leg Frame and 1-Right Leg Frame and connect the (C) 2-Supporting Rails between 2 Leg Frames with hardware (a) 4-Long Bolt, (c) 4-Spring Washer and (e) 4-Curve Washer.

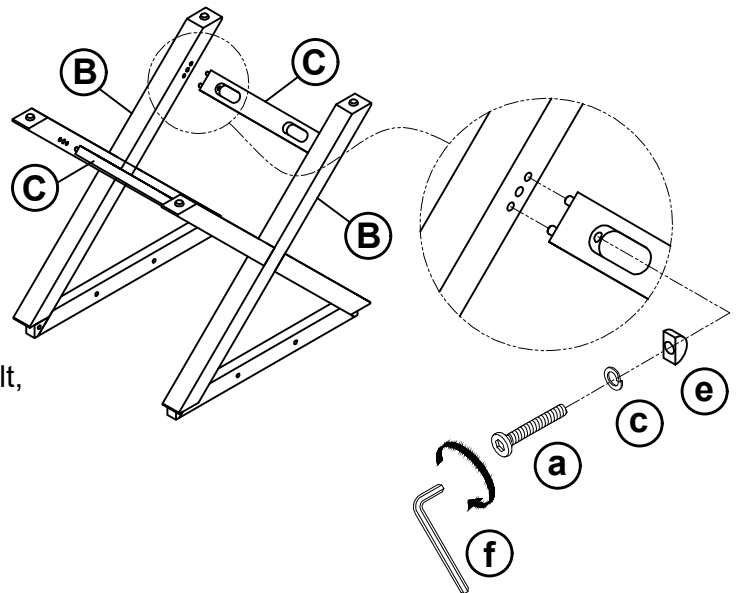

#### STEP 2

-Attach the Leg frames in STEP 1 to the (A) Case Body and please make sure the holes for support rails face inside.

-Set up the base and top using hardware (b) 8-Short Bolt, (c) 8-Spring Washer and (d) 8-Flat Washer.

#### NOTE:

Please make sure all the hardware are secured to the product.

In any correspondence regarding this product, please include the complete style number located at top of this assembly instruction sheet.

We hope this product will be a useful decorative addition to your home for yaers to come.

