

# ASSEMBLY INSTRUCTION

**This set is included 3 boxes if don't receive full 3 boxes please contact our customer service team**

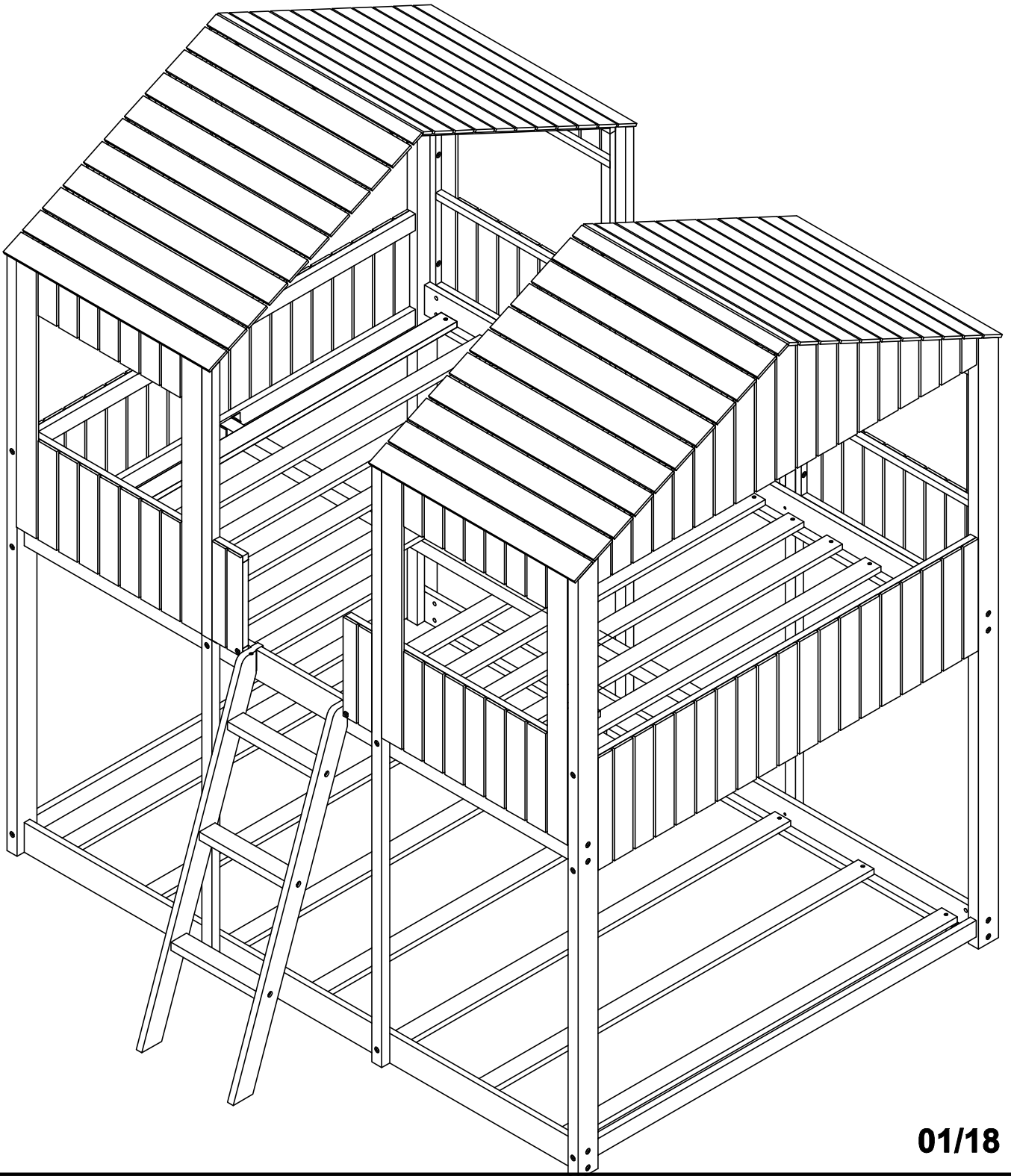

# **! SAFETY WARNINGS !**

1. This bed is designed for use only mattress(es) meeting the following specifications on the upper bunk, and lower bunk:

<b>Bed Type</b>	<b>Length</b>	<b>Width</b>	<b>Thickness</b>
<i>Twin Standard</i>	<i>74" - 75"</i>	<i>38 1/2"</i>	<i>6" max</i>
<i>Full Standard</i>	<i>74" - 75"</i>	<i>53 1/2 "</i>	<i>6" max</i>

2. Replacement parts, including additional guardrails, may be obtained from any of our dealers
3. Follow the information on the warnings appearing on the upper bunk bed end structure and on the carton. Do not remove warning label from bed.
4. Always use the recommended size mattresses or mattress supports, or both, to help prevent the likelihood of entrapment or falls.
5. Surface of the mattress must be at least 5 in. (127 mm) below the upper edge of guardrails.
6. Do not allow children under 6 years of age to use the upper bunk.
7. Periodically check and ensure that the guardrail, ladder, and other components are in their proper position, free from damage, and that all connectors are tight.
8. Do not allow horseplay on or under the bed and prohibit jumping on the bed
9. Always use the ladder for entering and leaving the upper bunk.
10. Do not use substitute parts. Contact the manufacturer or dealer for replacement parts.
11. Use of a night light may provided added safety precaution for a child using the upper bunk.
12. Always use guardrails on both long sides of the upper bunk. If the bunk bed will be placed next to the wall, the guardrail that runs the full length of the bed should be placed against the wall to prevent entrapment between the bed and wall.
13. The use of water or sleep flotation mattresses is prohibited.
14. **STRANGULATION HAZARD** – Never attach or hang items to any part of the bunk bed that are not designed for use with the bed; for example, but not limited to, hook, belts and jump ropes.
15. Keep these instructions for future reference

# DETAIL VIEW

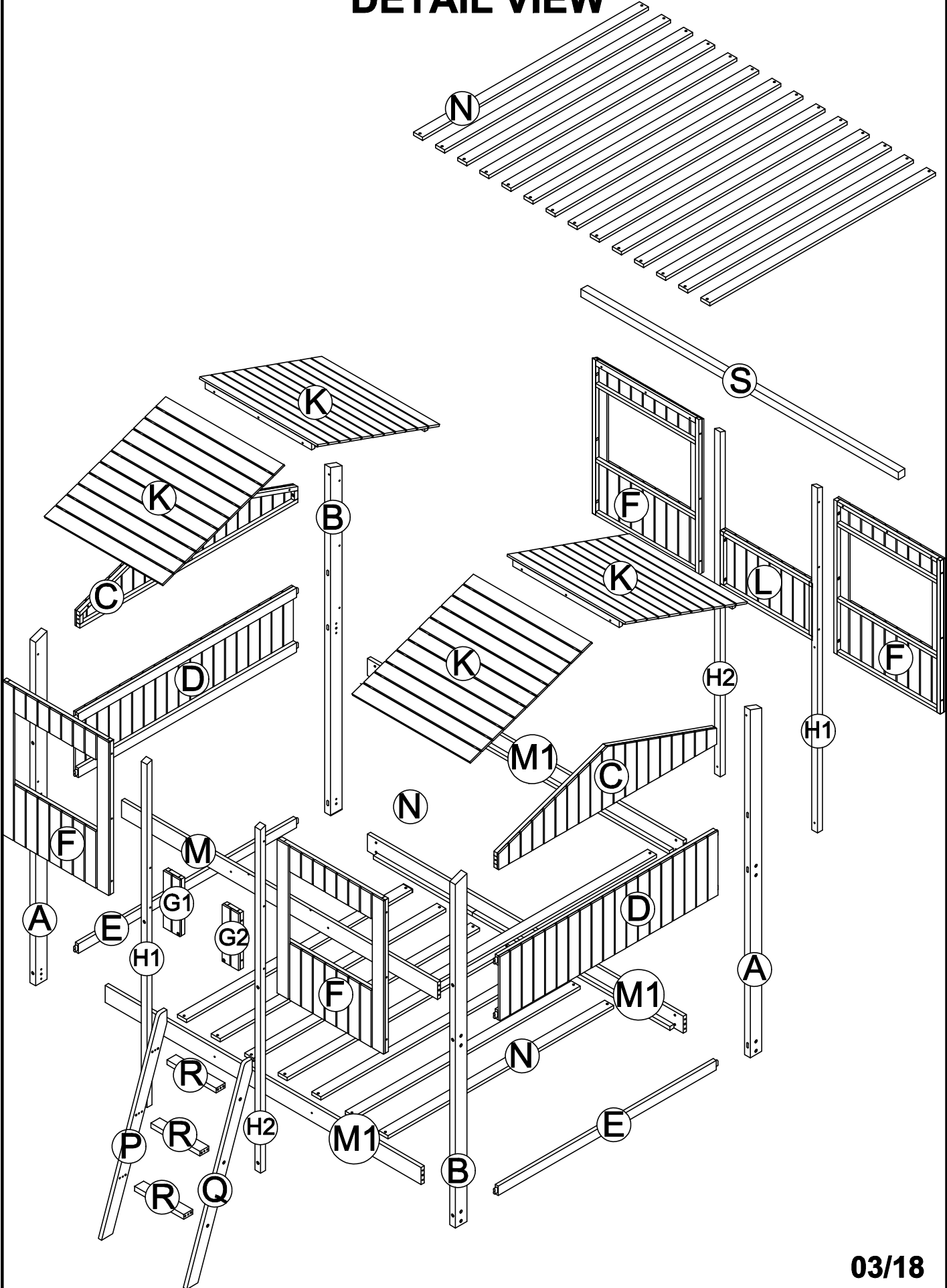

# Part List

F

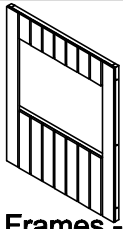

Front Frames - 4pcs

K

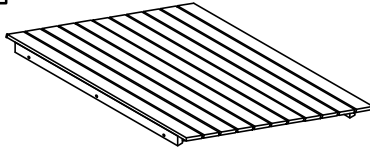





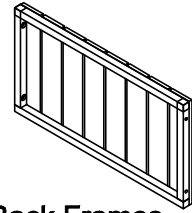

Roof Top Frames - 4pcs

L

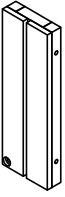

Back Frames - 1pcs

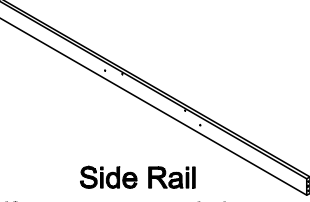
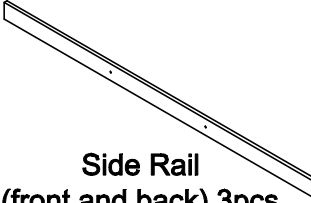
# Part List

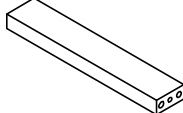
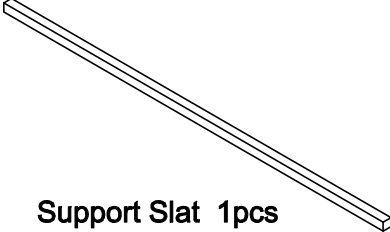
<b>A</b>  Legs- 2pcs	<b>B</b>  Legs- 2pcs	<b>G1</b>  Front Frames - 1pcs
<b>G2</b>  Front Frames - 1pcs	<b>H1</b>  Wood Bars - 2pcs	<b>H2</b>  Wood Bars - 2pcs
<b>M</b>  Side Rail (front and back) 1pcs	<b>M1</b>  Side Rail (front and back) 3pcs	<b>P</b>  Side Ladder(Left) 1pcs
<b>Q</b>  Side Ladder(Right) 1pcs	<b>R</b>  Step Ladder 3pcs	<b>S</b>  Support Slat 1pcs

# Part List

C

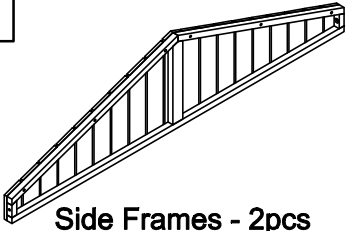

Side Frames - 2pcs

D



Side Frames - 2pcs

E

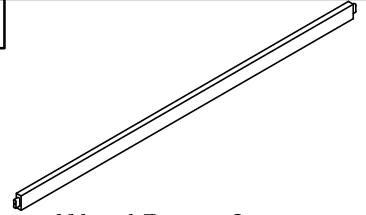





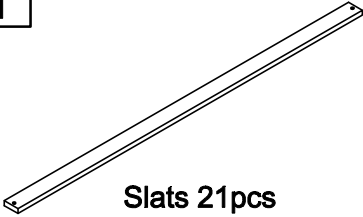

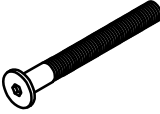
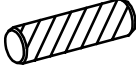

Wood Bars - 2pcs

N

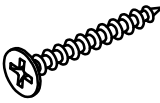
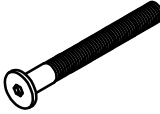

Slats 21pcs

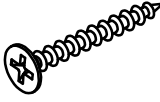
# Hardware List

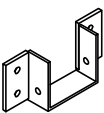
<p><b>1</b></p>  <p>Screws 1/4" x100 (12pcs)</p>	<p><b>2</b></p>  <p>Ø1/4" x 35 mm Hex-Head bolts 10pcs</p>	<p><b>3</b></p>  <p>Ø10 x 40 mm Wood dowel 20pcs</p>
<p><b>4</b></p>  <p>Ø1/4" x 80 mm Hex-Head bolts 16pcs</p>	<p><b>5</b></p>  <p>Ø1/4" x 13 mm Horizontal-Hole bolts 16pcs</p>	<p><b>6</b></p>  <p>Ø1/4" x 15 mm Canopy head through - 6pcs</p>
<p><b>7</b></p>  <p>Ø1/4" x 25 mm Hex-Head bolts 6pcs</p>	<p><b>8</b></p>  <p>M4 x 30 mm Wood Screws 42pcs</p>	<p><b>9</b></p>  <p>Ø1/4" x 30 mm Hex-Head bolts 60pcs</p>
<p><b>10</b></p>  <p>Screws 1/4" x50 (6pcs)</p>	<p><b>11</b></p>  <p>Bracket 2 pcs</p>	<p><b>12</b></p>  <p>M4 x 20 mm Wood Screws 14pcs</p>
<p><b>13</b></p>  <p>Allen Key 1pc</p>	<p><b>14</b></p>  <p>Steel Bracket 2pc</p>	

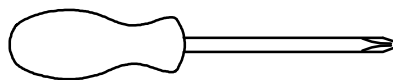

**Assembly Tools Required (Not Included)**

**STEP 1:** Following below illustration. . Using hardware #12 & #14 connect Steel Bracket(14) with D Frame.Look at detail view for more detail

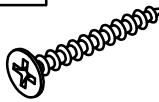
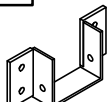
12 	14 
8(pcs)	2(pcs)

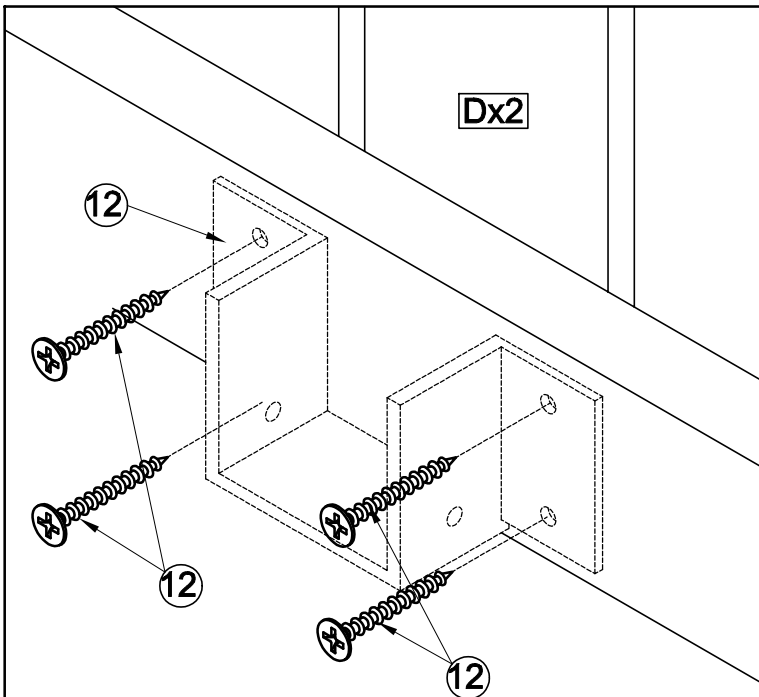
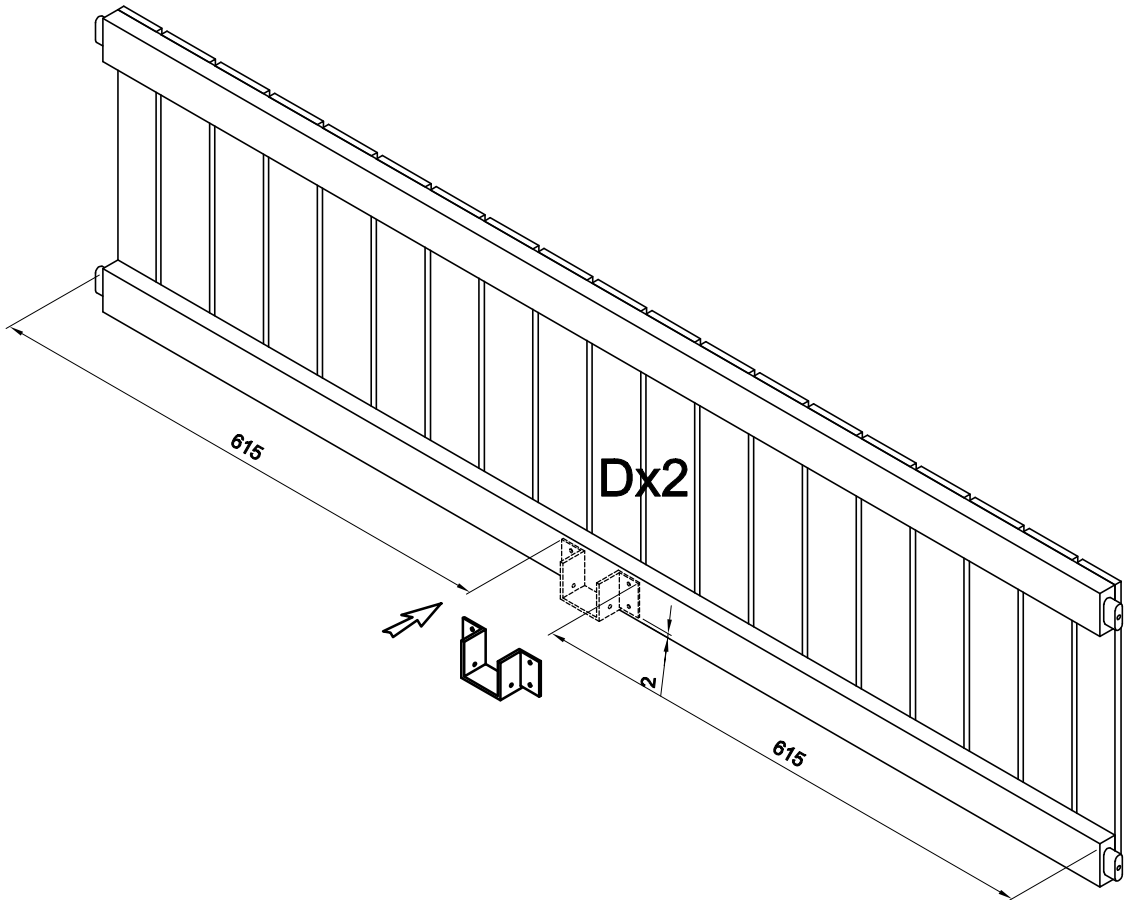

# STEP 2: Following below illustration Assembly Headboard and Footboard. Using hardware #1

& #9 connect A and B legs with E bar & C Frame & D Frame to complete LEFT & RIGHT side of Bed

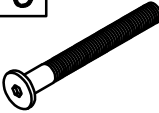
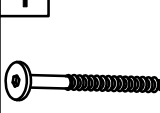
9	1
	
4(pcs)	12(pcs)

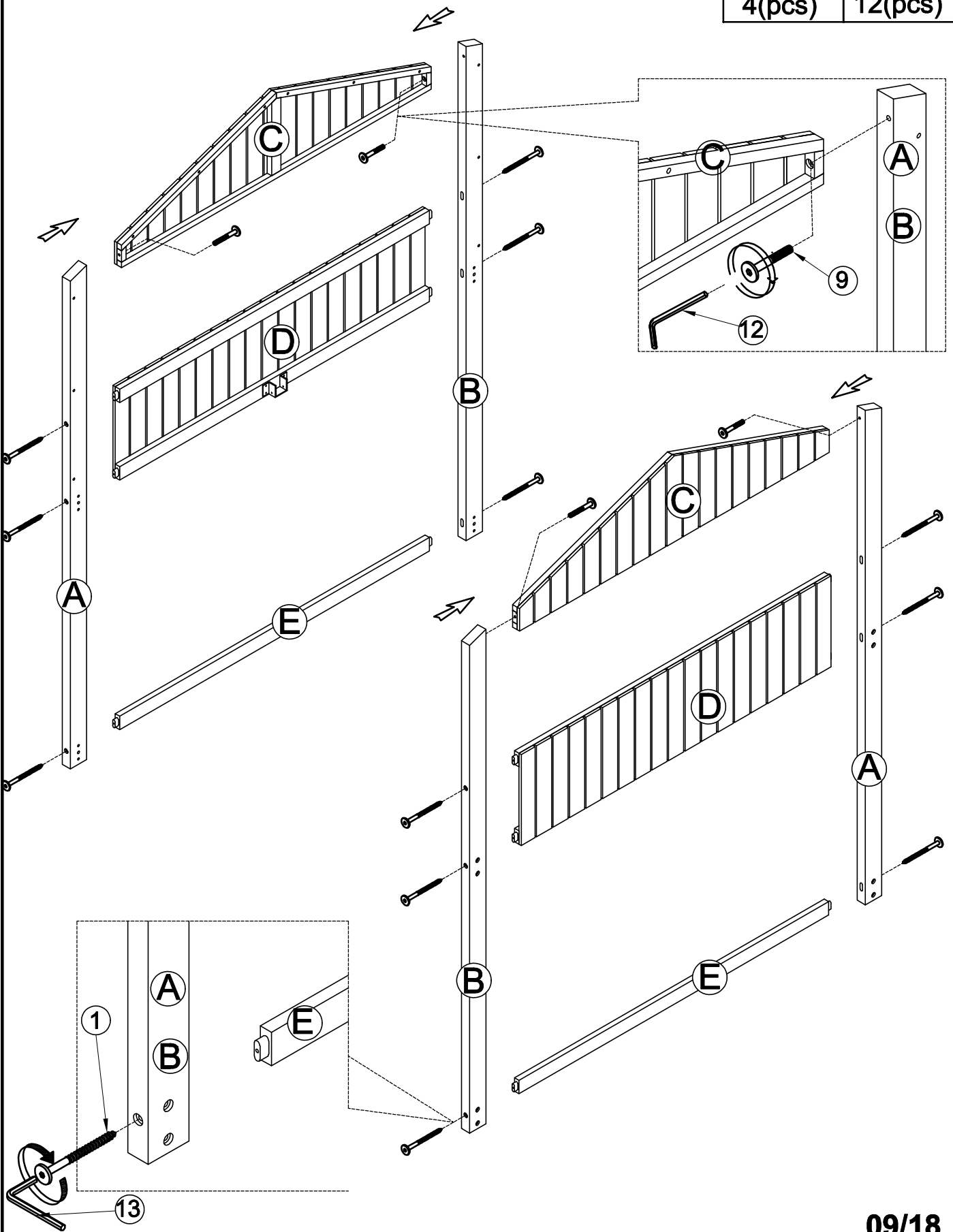

**STEP 3:** Following below illustration Using hardware #4, #5 and dowel #3 follow detail view to Assembly Bottom bed's Headboard and Footboard with siderail M (1)&M1 (3). Look at detail view for more detail

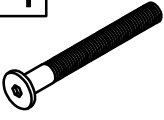
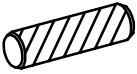
5 	4 	3 
16(pcs)	16(pcs)	8(pcs)

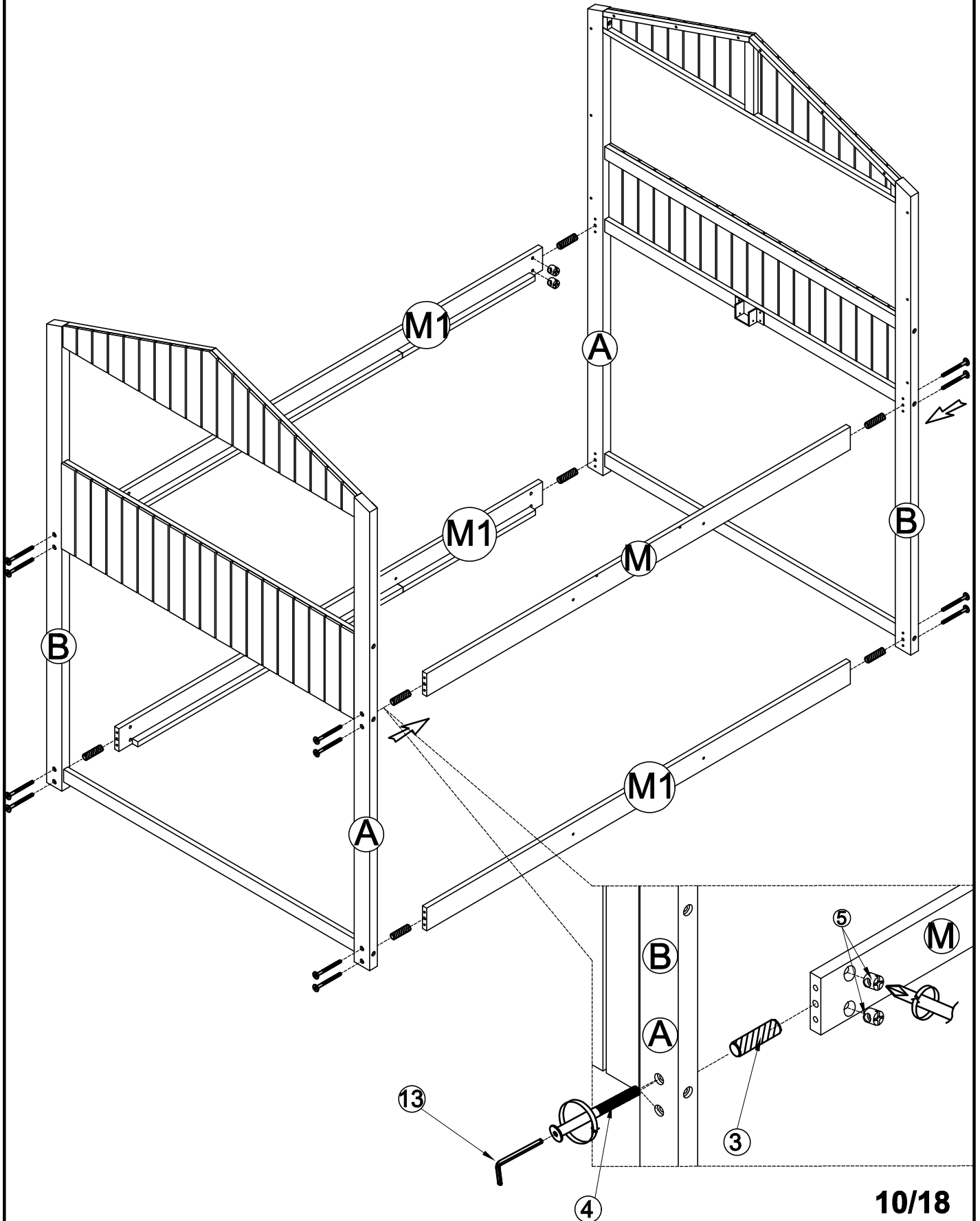

**STEP 4:** Following below illustration Using hardward #2,  
follow detail view to Assembly siderail G with H2(2)& H1(2). Look at  
detail view for more detail

2

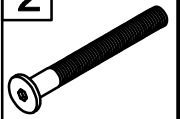

8(pcs)

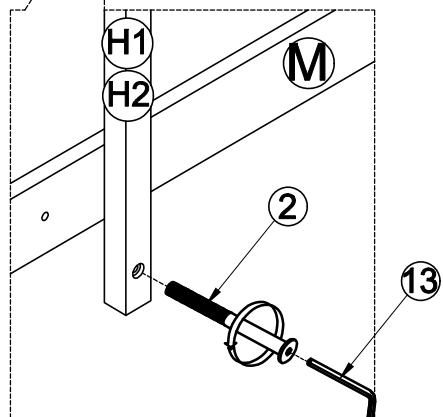
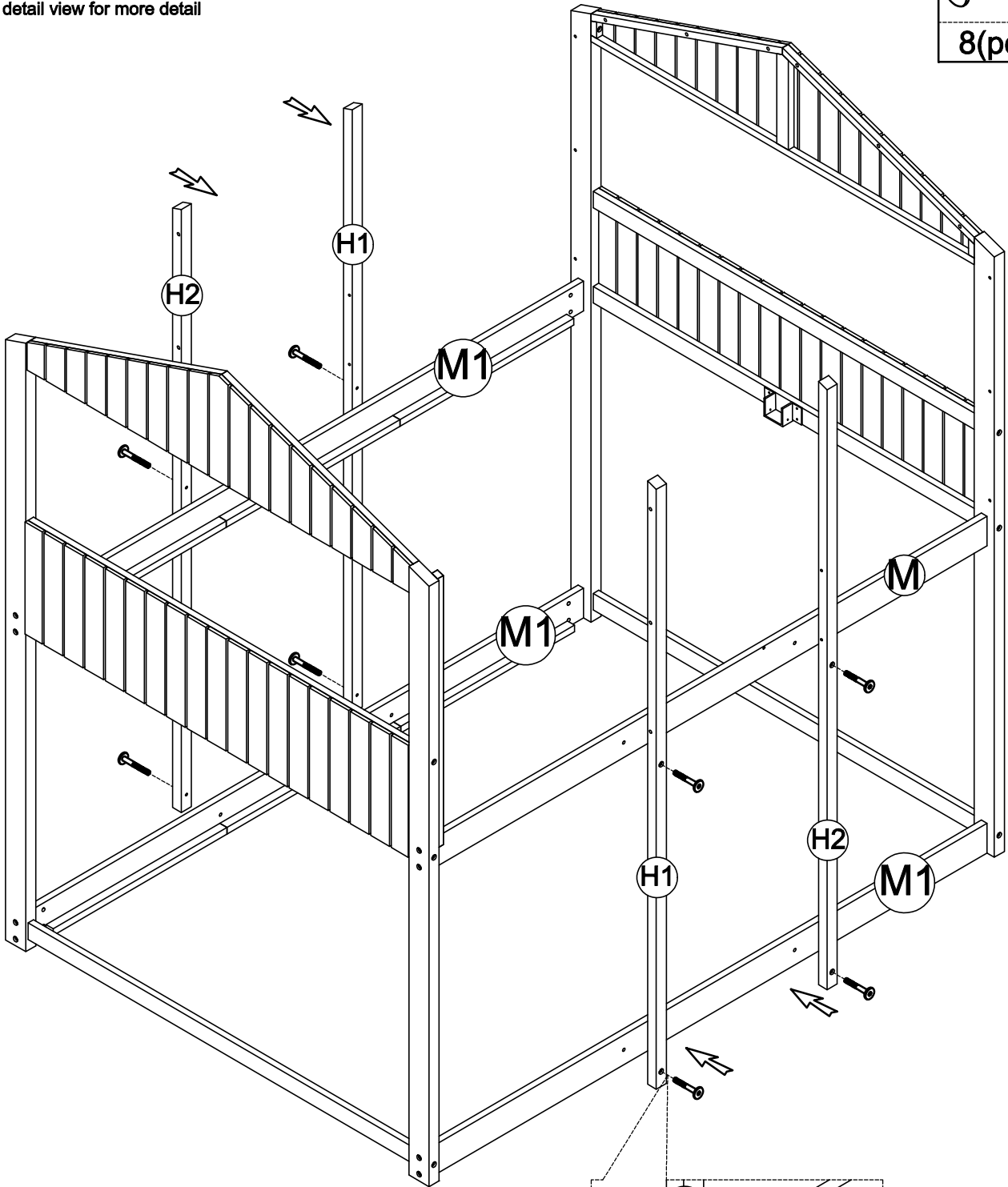

# STEP 5:

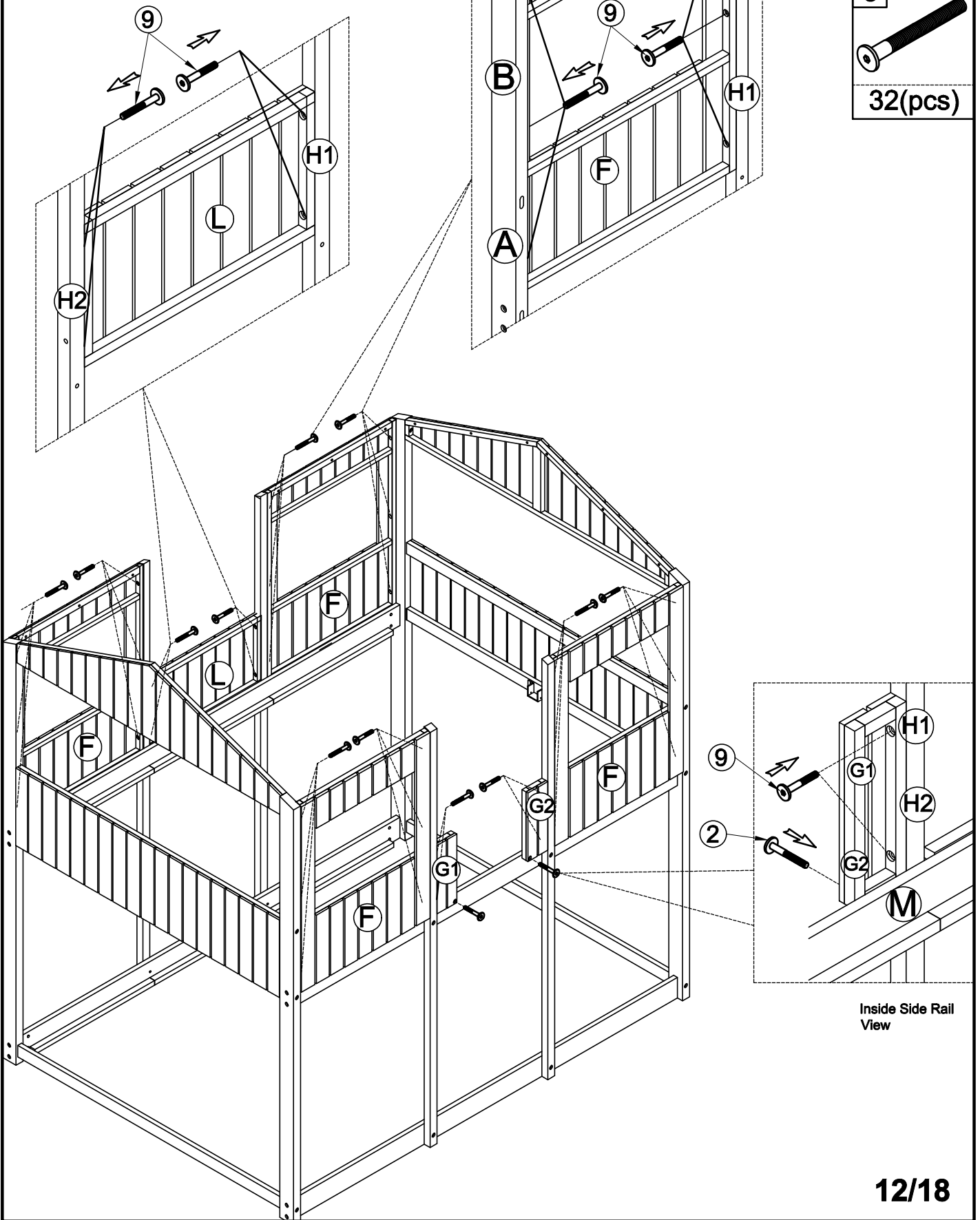

Following below illustration. Using hardware #2, #9 follow detail view to Assembly Bed Frame (just finished step 3) with F Frames(4), L Frame(1), G1 Frame(1), G2 Frame(1). Look at detail view for more detail



- |         |  |
|---------|--|
| 2       |  |
| 2(pcs)  |  |
| 9       |  |
| 32(pcs) |  |

Inside Side Rail View

**STEP 6:** Following below illustration. Using hardware #7,#8,  
follow detail view to Assembly Roof Top Frames . Look at detail view for more  
detail

7	6
	
6(pcs)	6(pcs)

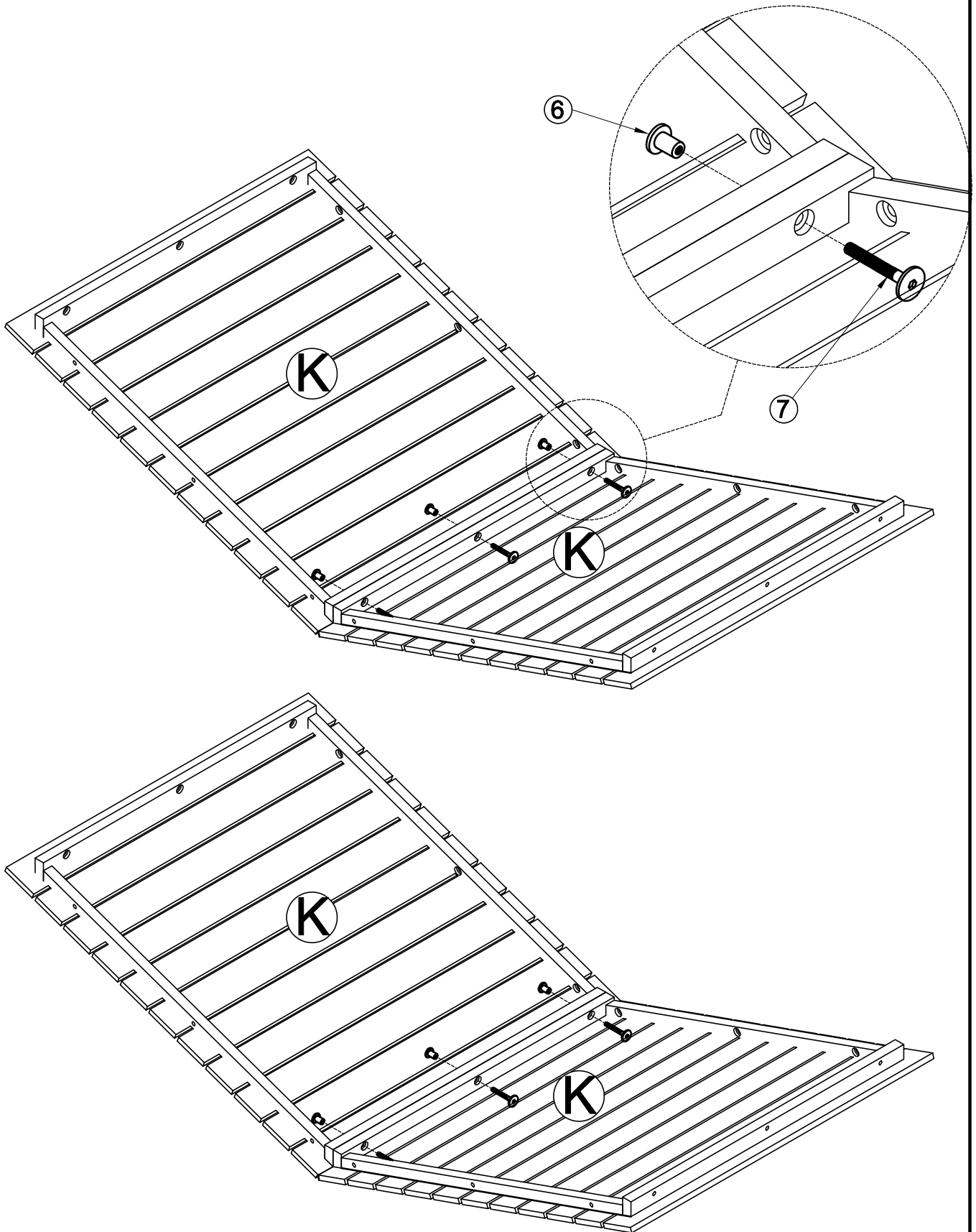

**STEP 7:** Following below illustration. Using hardware #9, follow detail view to  
Assembly Roof Top Frame(step 6) with Bed Frame(step 5) . Look at detail view for more detail

9

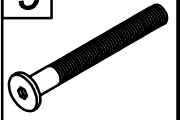

24(pcs)

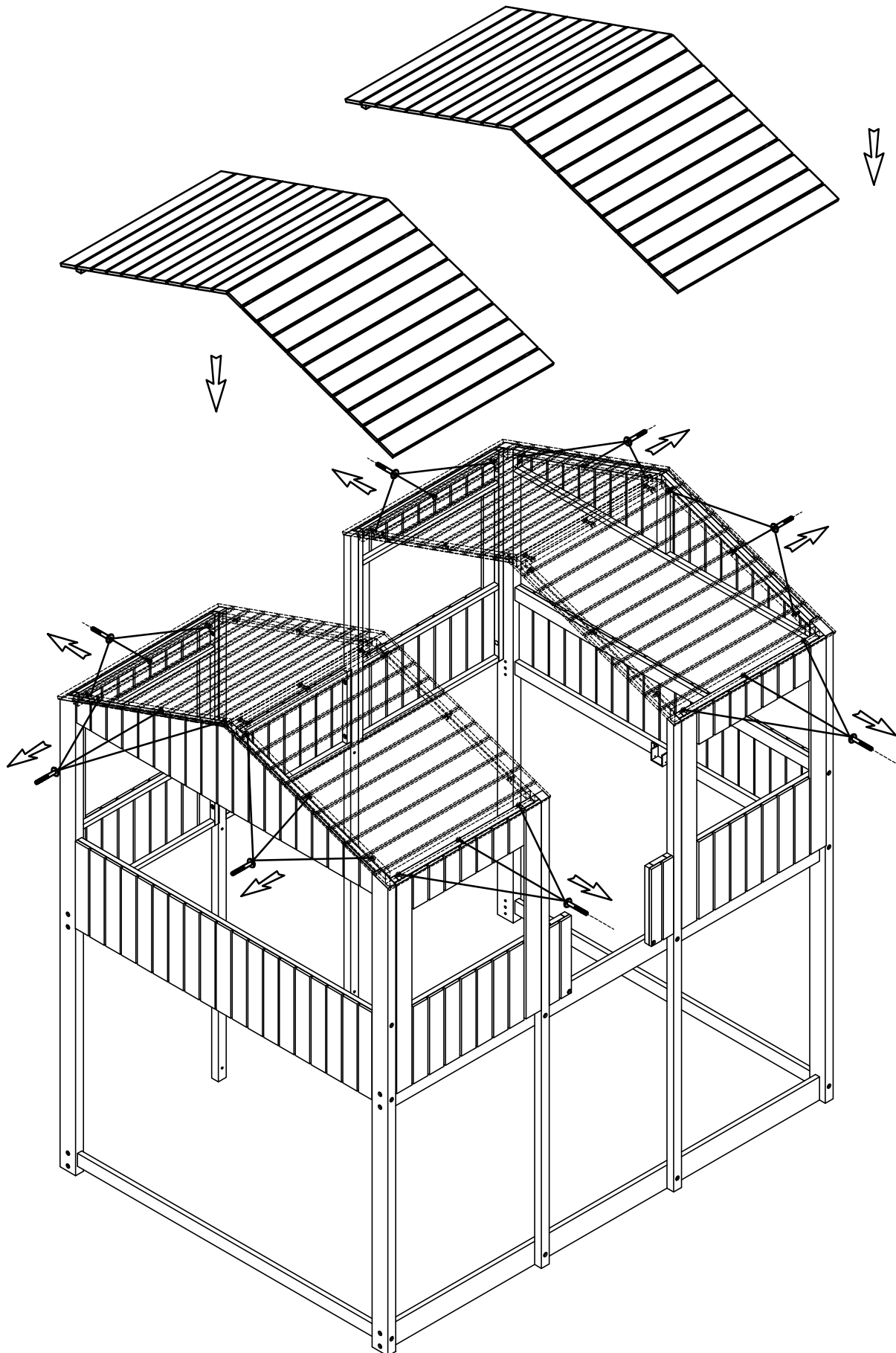

**STEP 8:** Following below illustration. Assembly Support Slat(S)

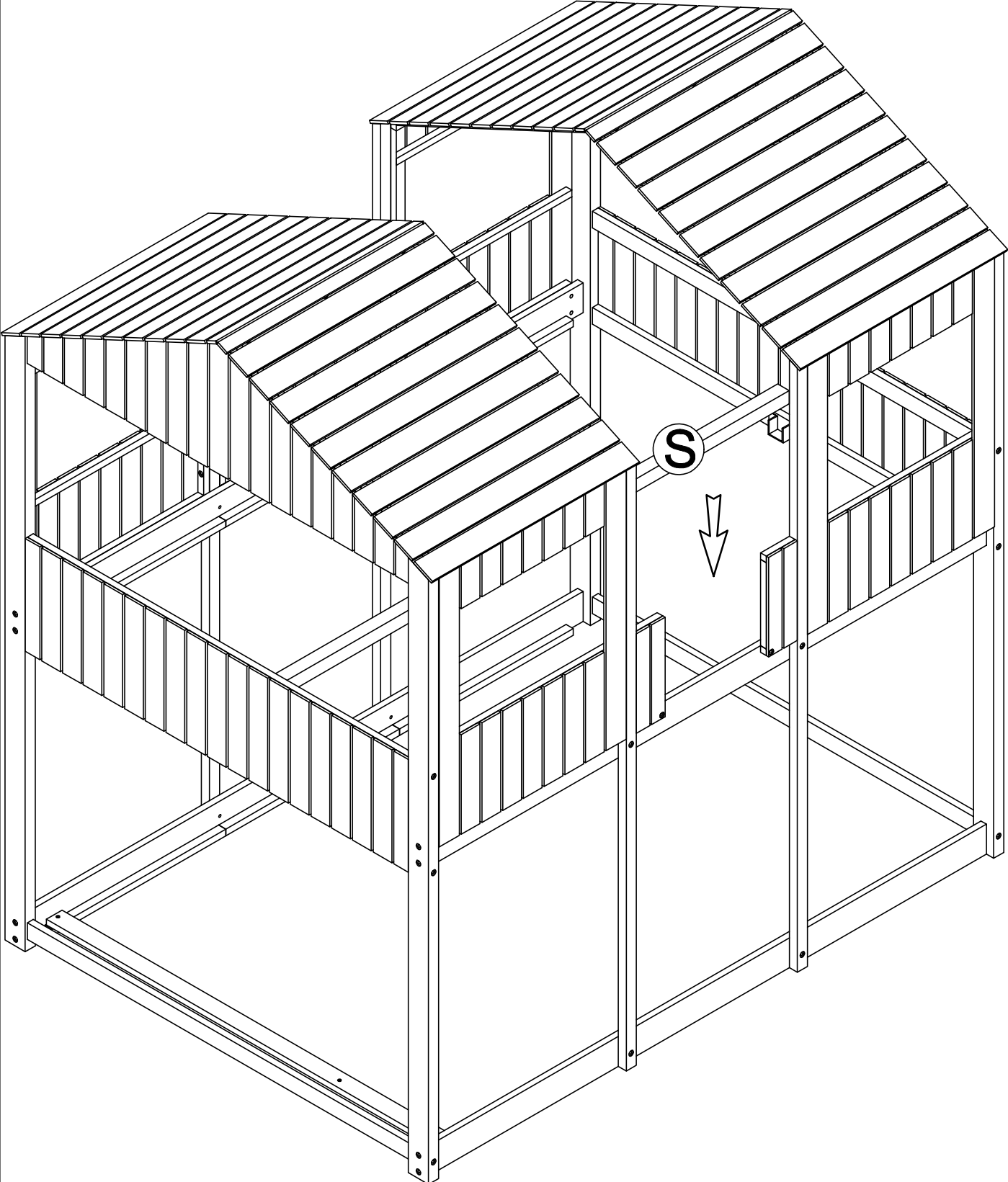

**STEP 9:** Following below illustration. Screw 21 slats N with Side Rail M by using hardward #8.

8

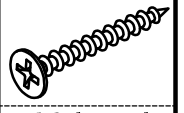

42(pcs)

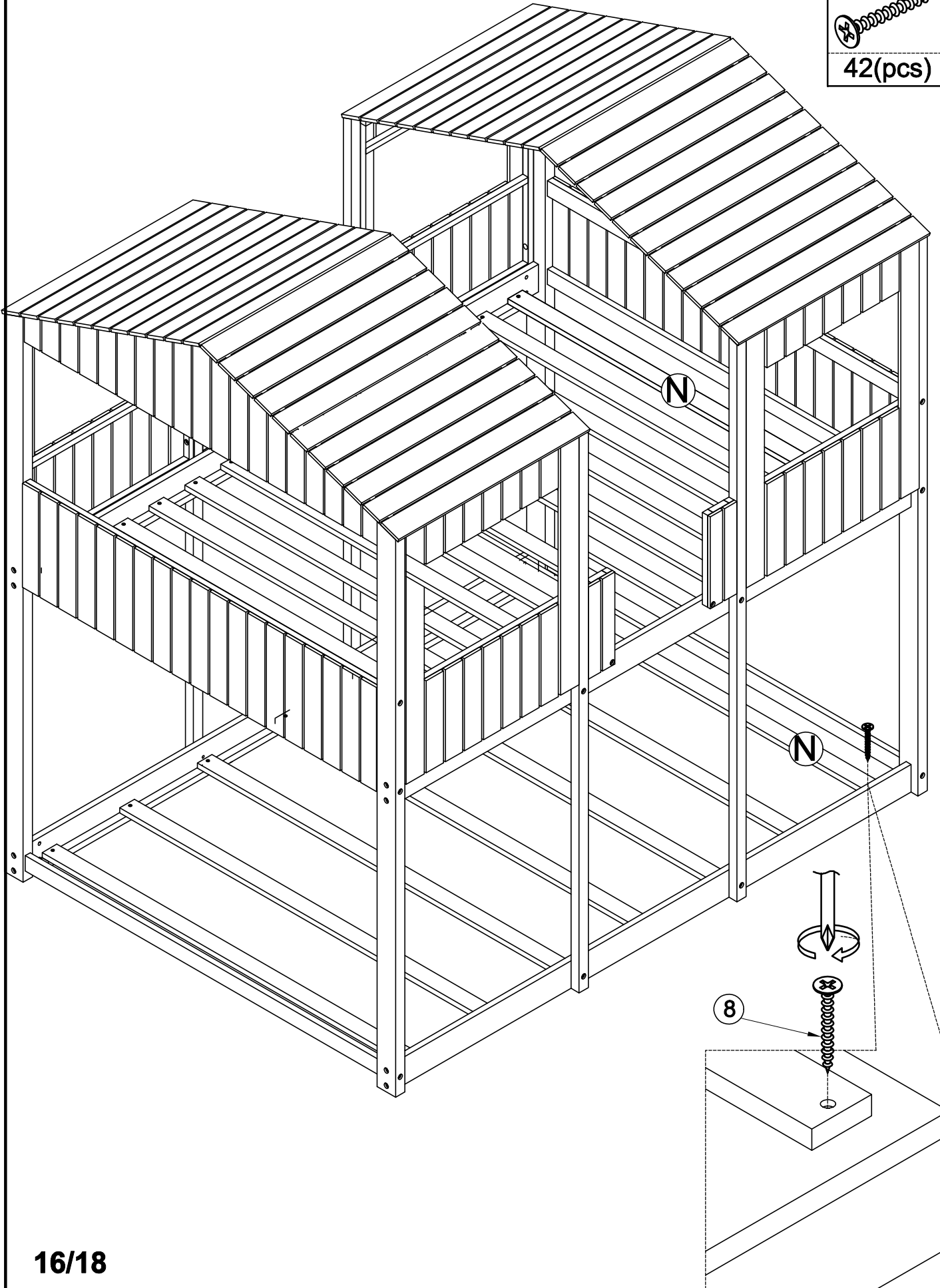

# STEP 10-1:

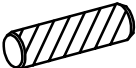

Following below illustration Using hardware #10, and dowel #3 follow detail view to Assembly Side Ladder (Left & Right) with Step Ladder R(3). Look at detail view for more detail

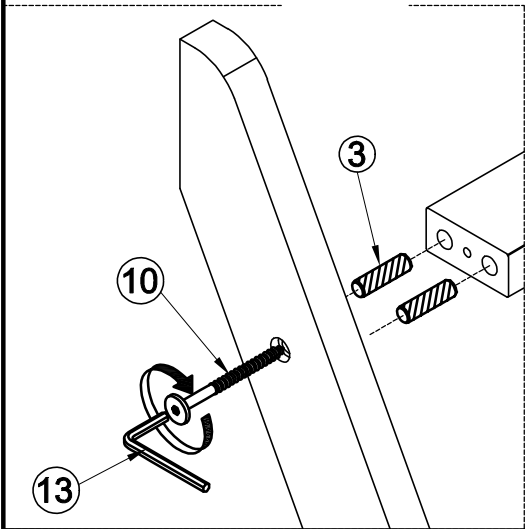
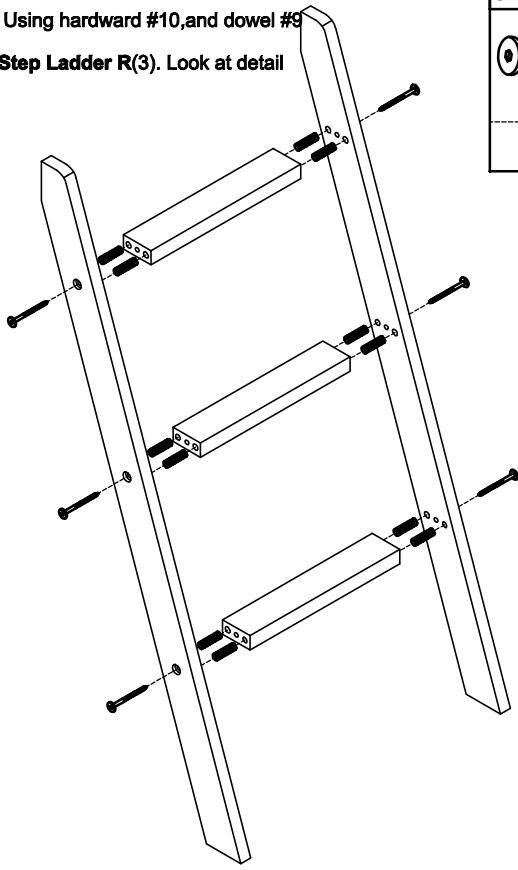
10	3
	
6(pcs)	12(pcs)



# STEP 10-2:

Following below illustration Using hardware #12 follow detail view to Assembly Steel Bracket 11 with Ladder. Look at detail view for more detail

12	11
	
4(pcs)	2(pcs)

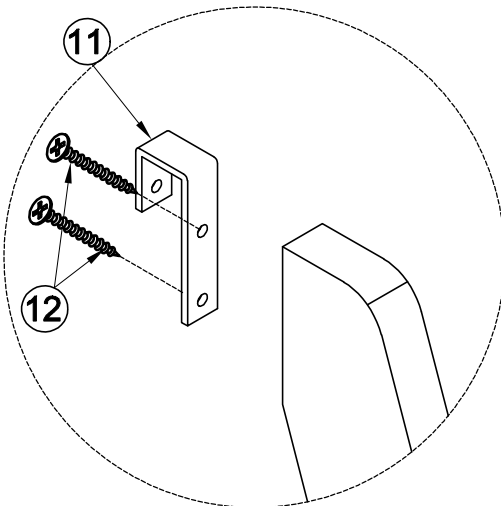
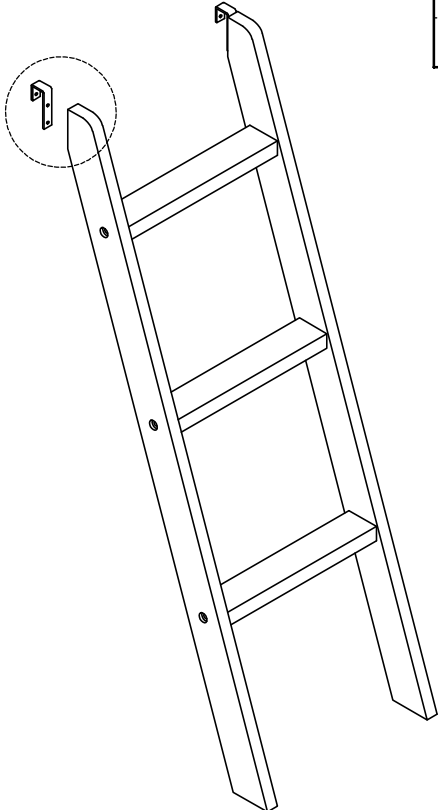

# STEP 11:

Following below illustration Using hardware #12 follow detail view to Assembly Ladder (step 10.2)

with bed(Step 9).Look at detail view for more detail

12



2(pcs)

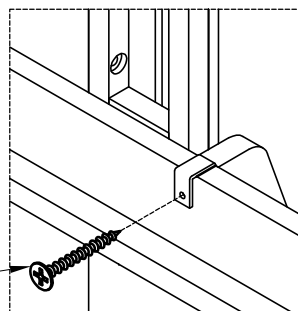
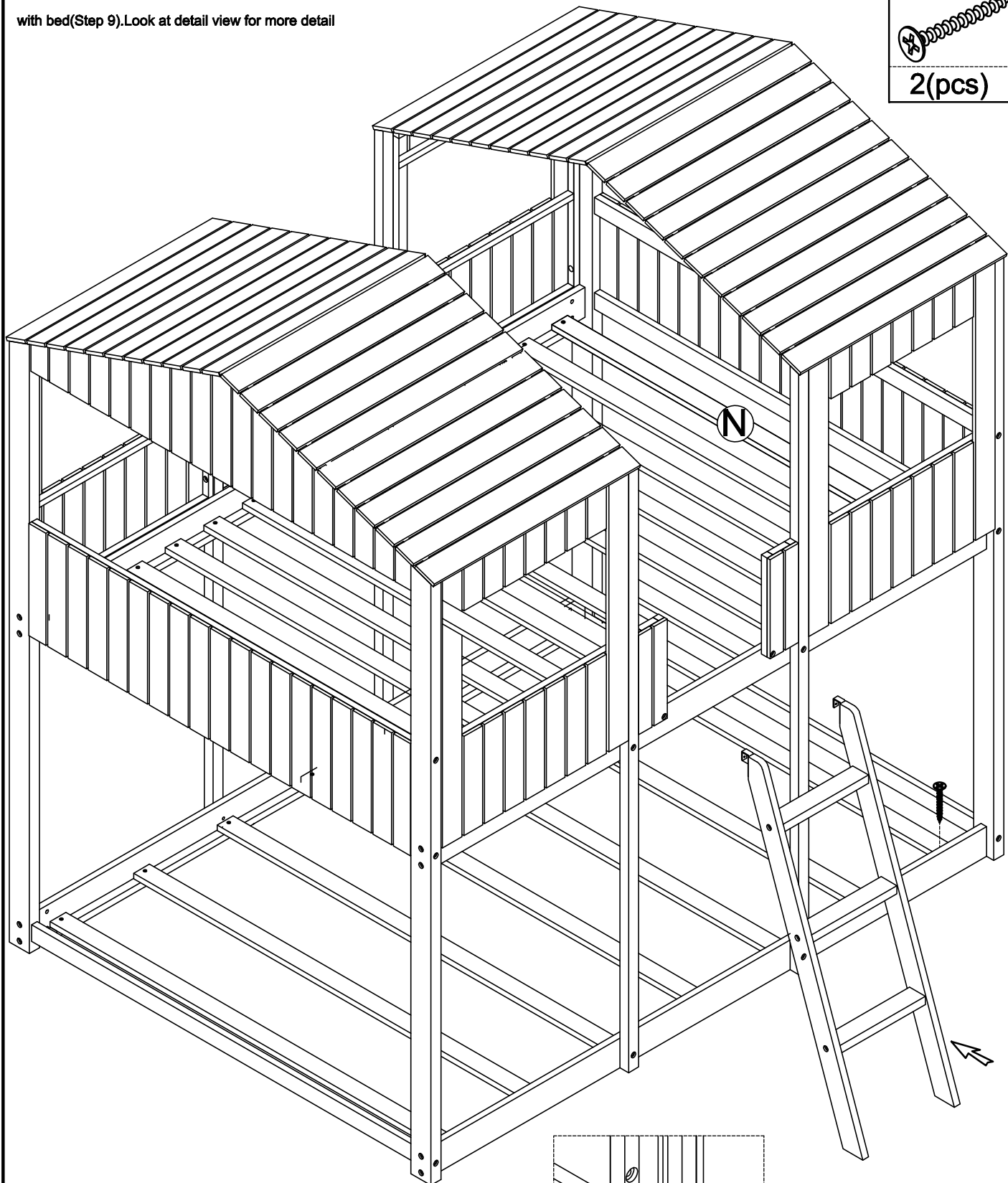

12

Inside Side Rail View