

ISTA 3 Series
General
Simulation
Performance
Test
Procedure

VERSION
DATE

Last

TECHNICAL

Change:

MARCH

2018

Last

EDITORIAL

Change:

MARCH

2018

For complete
listing of
Procedure
Changes and
Version Dates
go to
www.ista.org

ISTA, Distributing Confidence, Worldwide™

ISTA 3 Series tests are advanced tests and are designed to:

- Challenge the capability of the package and product to withstand transport hazards, **but**
- Utilize general simulation of actual transport hazards, **and**
- Do not necessarily comply with carrier packaging regulations.

When properly executed, ISTA procedures will provide tangible benefits of:

- Product to market time reduction
- Confidence in product launch
- Reduction in damages and product loss
- Balanced distribution costs
- Customer satisfaction contributing to increased market share

There are three sections to this Procedure: Overview, Testing and Reporting

- **Overview** provides general knowledge required before testing **and**
- **Testing** presents the specific instructions to do laboratory testing **and**
- **Reporting** indicates what data shall be recorded to submit a test report to ISTA.

Two systems of weights and measures are presented in ISTA test procedures: SI (Metric) or English system (Inch-Pound). Metric units are shown first followed by the Inch-Pound units in parentheses; there are exceptions in some tables (when shown separately).

Familiarity with the following units and symbols used in this document is required:

For measuring	Metric units and symbols	English units and symbols
Weight	kilograms (kg) or grams (gm)	pounds (lb)
Distance	meters (m) or millimeters (mm)	feet (ft) or inches (in)
Volume	Cubic centimeters (cm ³)	Cubic inches (in ³)
Density	kilograms per cubic meter (kg/m ³)	pounds per cubic inch (lb/in ³)
Temperature	Centigrade (°C)	Fahrenheit (°F)
Absolute Pressure	Kilopascal (kPa)	Pounds per square inch (psi)

- Either system may be used as the unit of measure (standard units), **but**
- The standard units chosen shall be used consistently throughout the procedure.
- Units are converted to two significant figures **and**
- Not exact equivalents.

NOTE:

In other ISTA Test Procedures 68 kilograms is used as the conversion from 150 pounds. In 3A, 70 kilograms and 150 pounds are used because it's a common dividing point found in parcel delivery systems from countries that use either metric (SI) or English (inch-pounds) units of measure.

VERY IMPORTANT:

The entire document shall be read and understood before proceeding with a test.

Preface

Test Procedure 3A is a general simulation test for individual packaged-products shipped through a parcel delivery system. The test is appropriate for four different types of packages commonly distributed as individual packages, either by air or ground. The types include standard, small, flat and elongated packages. 3A includes an optional test combining Random Vibration Under Low Pressure (simulated high altitude). This tests the container's (whether primary package or transport package) ability to hold a seal or closure and the retention of contents (liquid, powder or gas) without leaking.

STANDARD packaged-products shall be defined as any packaged-product that does not meet any of the definitions below for a small, flat or elongated packaged-product. A Standard packaged-product may be packages such as traditional fiberboard cartons, as well as plastic, wooden or cylindrical containers. Examples shown below:



SMALL packaged-products shall be defined as any packaged-product where the:

- volume is less than 13,000 cm³ (800 in³), **and**
- longest dimension is 350 mm (14 in) or less **and**
- weight is 4.5 kg (10 lb) or less.
- Example shown below:



FLAT packaged-products shall be defined as any packaged-product where the:

- shortest dimension is 200 mm (8 in) or less **and**
- next longest dimension is four (4) or more times larger than the shortest dimension, **and**
- volume is 13,000 cm³ (800 in³) or greater.
- Example shown below:



ELONGATED packaged-products shall be defined as any packaged-product where the:

- longest dimension is 900 mm (36 in) or greater **and**
- both of the package's other dimensions are each 20 percent or less of that of the longest dimension.
- Example shown below:

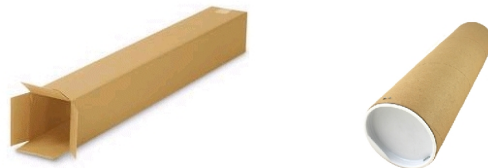
**NOTE:**

If a packaged-product is both Flat and Elongated, the package should be tested as Elongated.

Preface
Continued

- Testing can be used to evaluate the protective performance of a packaged-product related to vibrations, shocks and other stresses normally encountered during handling and transportation in a parcel delivery system.
- Test levels are based on general data and may not represent any specific distribution system.
- The package and product are considered together and not separately.
- Some conditions of transit, such as moisture, pressure or unusual handling may not be covered.

Other ISTA Procedures may be appropriate for different conditions or to meet different objectives.

Refer to *Guidelines for Selecting and Using ISTA Procedures and Projects* for additional information.

NOTE:

Hazardous material packaging that passes this test procedure may not meet international, national or other regulatory requirements for the transport of hazardous materials. **This test is not a substitute** for United Nations and/or any other required test standards for the transport of hazardous materials, but should be used as an additional test in conjunction with them.

Scope

Test Procedure 3A covers testing of individual packaged-products weighing 70 kilograms (150 pounds) or less when prepared for shipment via a parcel delivery carrier.

Product
Damage
Tolerance and
Package
Degradation
Allowance

The shipper shall determine the following prior to testing:

- what constitutes damage to the product **and**
- what damage tolerance level is allowable, if any, **and**
- the correct methodology to determine product condition at the conclusion of the test **and**
- the acceptable package condition at the conclusion of the test.

For additional information on this determination process refer to *Guidelines for Selecting and Using ISTA Procedures and Projects*.

Samples

Samples should be an untested actual package and product, but if one or both are not available, the substitutes shall be as identical as possible to actual items.

One (1) sample is required for this test procedure.

To permit an adequate determination of representative performance of the packaged-product, ISTA:

- Requires the procedure to be performed one time, **but**
- Due to the inherent variability of packaging as well as product characteristics, especially for those fragile items or items which contain liquids, it is recommended that Fragile & Liquid product types have two (2) or more packaged-product samples tested.

ISTA encourages performing the procedure five (5) or more times using new samples with each test to improve statistical significance for all package types. Refer to *Guidelines for Selecting and Using ISTA Procedures and Projects* for additional information on statistical sampling.

Definitions:

- **Fragile Products** – Items that could easily break when dropped without having protective packaging; for example- glass, ceramics, porcelains, clay, electronics, etc. See below for **Liquids** definition.
- **Liquids** - or semi-liquids or solids that can become liquid at high temperatures (above 70 degrees Fahrenheit) which can leak from a primary vessel during shipment.

NOTE:

In order to ensure testing in perfect condition, products and packages shipped to an ISTA Certified Laboratory for testing shall be:

- Adequately over-packaged for shipment **or**
- Repackaged in new packaging at the laboratory.

NOTE:

It is important to thoroughly document the configuration, materials, and construction of the tested product and package. Significant variations in performance can sometimes be caused by seemingly insignificant differences. Photo documentation is strongly recommended to supplement detailed written descriptions.

Basis Weight

Basis Weights of Corrugated Board

When the outer package is a corrugated box, it is strongly recommended that the basis weights of the papers/paperboards used to make the box be determined and documented. If the nominal basis weights change, even if the board is rated for the same performance, a retest is appropriate.

Refer to *Guidelines for Selecting and Using ISTA Procedures and Projects* for additional information on documentation and basis weight determination.

The tests shall be performed on each test sample in the sequence indicated in the following tables:

3A – STANDARD, ELONGATED & FLAT Packaged-Product Test

Sequence Number	Test Category	Test Type	Test Level	For ISTA Certification
1	Atmospheric Preconditioning TEST BLOCK 1	Temperature and Humidity	Ambient	Required
2	Atmospheric Conditioning TEST BLOCK 1	Controlled Temperature and Humidity	Temperature and Humidity chosen from chart	Optional
3	Shock TEST BLOCK 3	Drop	9 Drops - height varies with packaged-product weight	Required
4	Vibration TEST BLOCKS 4 & 7 for Standard TEST BLOCKS 5 & 7 for Pails and Short Cylinders	Random With and Without Top Load	Overall G _{rms} levels of 0.53 and 0.46	Required
5	Vibration TEST BLOCKS 2 & 8	Random Vibration Under Low Pressure	Truck or Truck & Air dependent	Optional
6	Shock TEST BLOCK 9	Drop	8 Drops - height varies with packaged-product weight. Includes drop on hazard	Required
7	Shock TEST BLOCK 10	Rotational Edge Drop	200 mm (8 in)	Required for FLAT and ELONGATED
8	Shock TEST BLOCK 11	Full Rotational Flat Drop	Varies with packaged-product dimensions	Required for FLAT and ELONGATED
9	Shock TEST BLOCK 12	Concentrated Impact	Hazard Box dropped 400 mm (16 in)	Required for FLAT ONLY
10	Shock TEST BLOCK 13	Bridge Impact	Hazard Box dropped 400 mm (16 in)	Required for ELONGATED ONLY
11	Integrity TEST BLOCK 14	Leak Test	8 hours	Required for LIQUIDS ONLY

Continued the next page

3A – SMALL Packaged-Product Test

Test
Sequence
SMALL

Sequence Number	Test Category	Test Type	Test Level	For ISTA Certification
1	Atmospheric Preconditioning TEST BLOCK 1	Temperature and Humidity	Ambient	Required
2	Atmospheric Conditioning TEST BLOCK 1	Controlled Temperature and Humidity	Temperature and Humidity chosen from chart	Optional
3	Shock TEST BLOCK 3	Drop (not in a bag)	9 Drops - height varies with packaged-product weight	Required
4	Vibration TEST BLOCKS 6 & 7	Random With and Without Top Load	Overall G _{rms} level of 0.53 and 0.46	Required
5	Vibration TEST BLOCKS 2 & 8	Random Vibration Under Low Pressure	Truck or Truck & Air dependent	Optional
6	Shock TEST BLOCK 9	Drop (in a bag)	7 Drops – height varies with packaged-product weight	Required
7	Integrity TEST BLOCK 14	Leak Test	8 hours	Required for LIQUIDS ONLY

O

EQUIPMENT REQUIRED FOR PROCEDURE 3A

Equipment
Required
Atmospheric
Conditioning

Atmospheric Conditioning:

- Humidity recorder complying with the apparatus section of ISO 2233 or ASTM D 4332.
- Temperature recorder complying with the apparatus section of ISO 2233 or ASTM D 4332.

Optional Atmospheric Conditioning

- Chamber and Control apparatus complying with the apparatus section of ISO 2233 or ASTM D 4332.

Continued the next page

Equipment
Required
Shock

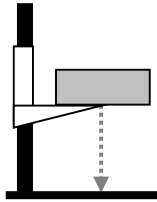
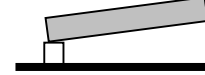
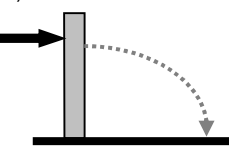
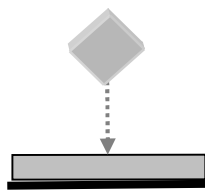
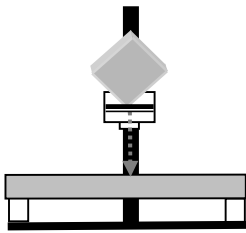
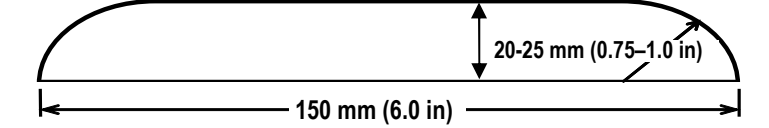
	All Protocols	Flat and Elongated	Flat	Elongated
Type of Shock Test	Drop Test	Rotational Edge Drop Test Full Rotational Test	Hazard Impact Test	Bridge Impact Test
Type of Equipment	Free-fall drop tester 	1) Support Block  2) 	Hand Drop with Hazard Box 	Free-fall Drop Tester with Hazard Box 
In compliance with the apparatus section of...	ISO 2248 or ASTM D 5276	ISO 2876 or ASTM D 6179		ASTM D 5265 with the exception of the Hazard Box (Impactor). See below
Additional Required Equipment	Hazard block See below.	Support block 90 to 100 mm (3.5 to 4.0 in) in height and width and at least 200 mm (8 in) longer than the shortest dimension of face 3.	Hazard box 300 x 300 x 300 mm (12 x 12 x 12 in) dense wooden box with a total weight of 4.1 kg (9 lb) The box shall have least one bottom edge covered by angle iron. The box should be filled with a sand bag and void fill to hold the bag in place.	Support blocks (2) 90 to 100 mm (3.5 to 4.0 in) in height and width and at least 200 mm (8 in) longer than the shortest dimension of face 3.
<p>Hazard block: The block shall be made of hardwood or metal. The height shall be 20 to 25 mm (0.75 to 1.0 in) and the width 150 mm (6.0 in). The length shall be at least 200 mm (8.0 in) longer than the second shortest package dimension of the length, width and height. The long top edges of the block shall be rounded to a radius equal to the height of the block \pm 2.0 mm (0.0625 in).</p> 				

Equipment Required Vibration

Random Vibration Test:

- Random Vibration Test System complying with the apparatus section of ISO 13355 or ASTM D 4728.
- A form of column stack fixturing
- Top-Load Apparatus
- Plastic bags
- Sand or other dense, flowable material

Optional Random Vibration Under Low Pressure:

- Low Pressure Chamber: complying with the apparatus section of ISO 2873 or ASTM D 6653; able to fit on the vibration table; able to draw down the internal absolute pressure to 60 kPa (8.7 psi) for the truck and air test, or 70 kPa (10 psi) for the truck-only test; and able to withstand the air and/or truck random vibration input.

Equipment Required Additional



3A - SMALL

- Two (2) large Consolidation Bags, approximately 1.0 x 0.7 m (39 x 27 in), made of canvas, polyolefin film/fabric, or similar strong flexible material, and with a zipper or other suitable closure at one end. The bags shall have sufficient capacity and strength to meet the requirements below, in the "Before You Begin Vibration Under Dynamic Load Testing" section, and in Test Block 6 (Vibration for Small).
 - One bag is the Top Load Bag, filled with 36 kg (80 lb) of sand, or other dense, flowable material, suitably packaged in smaller bags.
 - One bag is the Sample Bag, filled with the Test Specimen and dunnage packages, to simulate a typical pack.
- Three (3) over-night style envelopes, 1-#5 padded mailer and 1-#6 fiberboard mailer.
- Fiberboard containers as described in the table below are to be constructed of C-flute board with any of the following **minimum** values and construction:
 - Burst Test: 1380 kPa or 14 kg/cm² or 200 lb/in² **or**
 - ECT Value: 7.0 kN/m width or 40 lb/in width
 - RSC style boxes shall be used for any dunnage package 125 mm (5 in) or more in height **and**
 - Book-wrap or telescoping tray may be used for any dunnage package less than 125 mm (5 in) in height.
- Fill each envelope, mailer and corrugated container as indicated in the table below. Corrugated boxes and book wraps are filled until the desired weight is achieved.
 - It is allowable to substitute dunnage packages with Test Specimen packages or envelopes. The dunnage package that most closely represents the Test Specimen shall be substituted. Internal voids of dunnage packages should be filled in order to secure dunnage weight and eliminate concentrated load.

The following describes the numbers and sizes of each dunnage package:

Quantity	Package Type	Approximate Size LxWxH		Contents	Approximate Weight	
		Millimeters (mm)	Inches (in)		Kilograms (kg)	Pounds (lb)
3	Over-night envelope	318 x 242	12 ½ x 9 ½	25-sheets of paper		
1	#5 Padded mailer	268 x 407	10 ½ x 16	50-sheets of paper		
1	#6 Fiberboard mailer	318 x 483	12 ½ x 19	50-sheets of paper		
1	Fiberboard box or Book-wrap or Telescoping tray	200 x 125 x 50	8 x 5 x 2	Each corrugated package type and size shall be filled with foam, paper, sand, etc until the desired weight indicated in this table is achieved.	0.5	1.0
1		225 x 150 x 50	9 x 6 x 2		0.5	1.0
1		275 x 275 x 100	11 x 11 x 4		1.0	2.0
1		275 x 200 x 100	11 x 8 x 4		1.0	2.0
1		175 x 150 x 100	7 x 6 x 4		1.8	4.0
1		300 x 300 x 75	12 x 12 x 3		1.8	4.0
1	Fiberboard box	200 x 200 x 200	8 x 8 x 8	4.5	10.0	
1		150 x 150 x 150	6 x 6 x 6	1.0	2.0	
1		250 x 125 x 125	10 x 5 x 5	1.0	2.0	

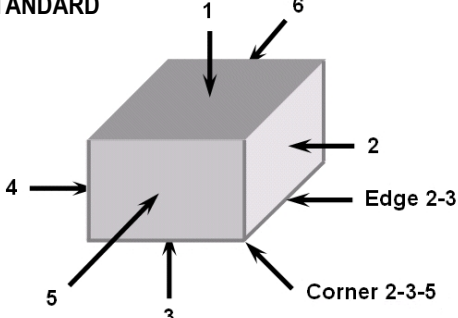
Prior to beginning the tests identify the faces, edges and corners according to the procedure below.

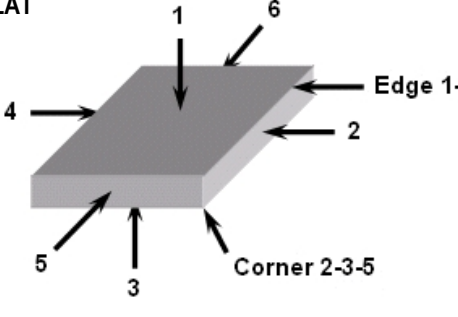
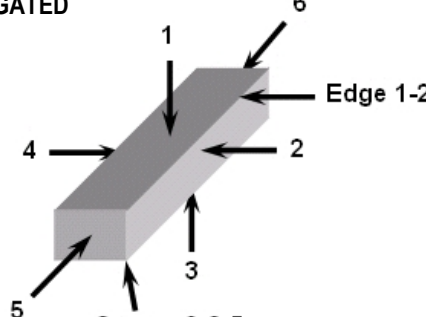
Step	Action	
1	Place the packaged-product so the package is in its most stable orientation (NOTE: most stable orientation may be different than intended shipping orientation. The most stable orientation is the orientation where the center of gravity is the lowest. If the center of gravity is unknown for a packaged-product then the packaged-product should be placed with its largest face down.)	
	IF the test specimen is ...	THEN...
	A Standard, Small, Flat or Elongated with only six faces (2 sides, 2 ends, top and bottom)	Turn the packaged-product so that one of the smallest faces is directly in front of you. If the one end of the package is noticeably heavier than the other, then position the smallest face with the heaviest end directly in front of you. See Step 2.
	A Standard, Small, Flat or Elongated with less than or more than six faces	Develop a method to identify each face, edge and corner and document with a diagram.
	A filled Consolidation Bag or other bag	Turn the filling end toward you with a side seam (if applicable) on the right and facing downward (nearest the surface). The longitudinal seam (middle seam), if present, should be facing downward and resting on the surface. See Step 2.
	An express envelope or similar type mailer	Position the envelope or mailer so that it is lying flat and the opening is toward you. See Step 3.
A Cylinder or Pail	See Step 4	
2	STANDARD 	CONSOLIDATION BAG FOR SMALL 
	FLAT 	ELONGATED 
	Identify faces according to the diagrams. Identify edges using the numbers of the two faces forming that edge. Example: Edge 1-2 is the edge formed by face 1 and face 2 of the packaged-product. Identify corners using the numbers of the three faces that meet to form that corner. Example: Corner 2-3-5 is the corner formed by face 2, face 3, and face 5 of the packaged-product. Identify orientation of the product inside the package as it rests on the vibration table.	
	Continued next page	

Continued from previous page

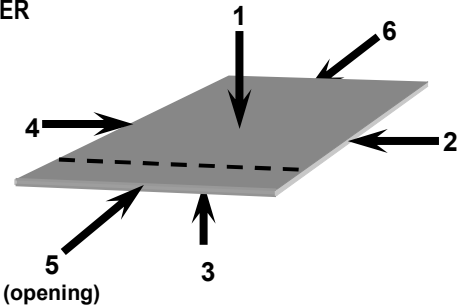
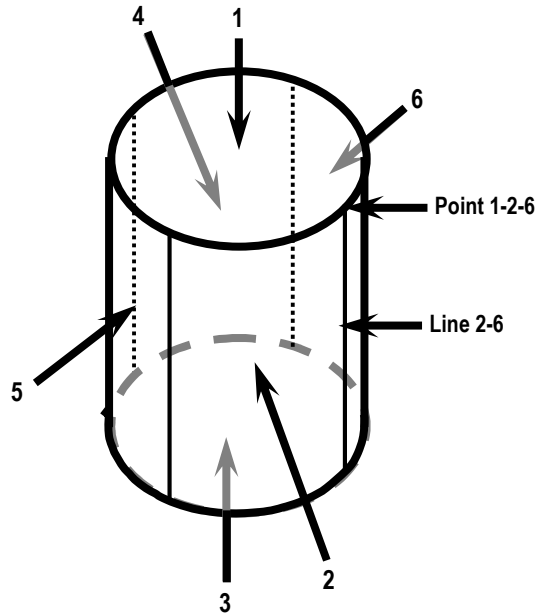
Step	Action
3	<p>TWO-DIMENSIONAL EXPRESS ENVELOPE OR MAILER</p> <p>Mark the face that is up (typically with label) as 1 The right end is 2 The left end is 4 The opening of the envelope shall be 5 (top) The end opposite 5 (top) shall be 6 (bottom) Mark the face that is down (typically with flap) as 3</p> 
4	<p>SHORT CYLINDER OR UNPACKAGED PAIL</p> <p>Identify top and bottom as surfaces 1 and 3, according to the diagram.</p> <p>Designate four sidewall line locations, equally spaced around the perimeter of the container as shown. Identify sidewall surfaces between the lines as shown. The lines shall be designated as intersections between the sidewall surfaces. Example: line 2-6 is the intersection between sidewall surfaces 2 and 6.</p> <p>If the cylinder has one or more side seam joints, one of these seams shall be coincident with line 2-6.</p> <p>Identify points on the chimes using the top or bottom number and the numbers of the sidewall line that intersect to form that point. Example: point 1-2-6 is the intersection with top 1 and sidewall line 2-6.</p> <p>NOTE: If a packaged-product is both Cylinder or Pail and Elongated, the package faces, edges and corners should be identified as Elongated.</p> 

Packaged-
Product
Weight and
Size
Measurement

Before You
Begin
Atmospheric
Conditioning

You shall know the packaged-product's:

- Gross weight in kilograms (kg) for Metric and pounds (lb) for English units
- Exterior dimensions of Length, Width and Height (L x W x H) in millimeters (mm) or meters (m) for Metric and inches (in) or feet (ft) for English units.

Required Preconditioning:

The packaged-product shall be preconditioned to laboratory ambient temperature and humidity for twelve (12) hours prior to testing.

Optional Conditioning Recommended (to be performed after the required preconditioning):

To permit an adequate determination of packaged-product performance at anticipated atmospheric limits and where it is known that the atmospheric extremes are detrimental to the product, ISTA:

- **Requires** the highest temperature and humidity limits of the product be used, **but**
- **Recommends** that both the highest and lowest atmospheric conditions be used.

Condition packaged-products according to one or more of the conditions listed in the table below.

- Remaining test requirements should be performed as soon as possible after removing the packaged-product from environmental conditioning apparatus.

NOTE: If more than one conditioning sequence is selected, a new and complete test should be performed following each sequence.

Anticipated Conditions	Time in Hours	Temperature in °C ±2°C (°F ±4°F)	Humidity in %
Extreme Cold, Uncontrolled RH	72	-29°C (-20°F)	Uncontrolled RH
Cold, Humid	72	5°C (40°F)	85% RH ±5%
Controlled Conditions	72	23°C (73°F)	50% RH ±5%
Hot, Humid	72	38°C (100°F)	85% RH ±5%
Hot, Humid then Extreme Heat, Moderate RH:	72 then 6	38°C (100°F) then 60°C (140°F)	85% RH ±5% then 30% RH ±5%
Elevated Temperature, Uncontrolled RH	72	50°C (120°F)	Uncontrolled RH
Extreme Heat, Dry	72	60°C (140°F)	15% RH +/- 5%
Severe Cold, Uncontrolled RH	72	-18°C (0°F)	Uncontrolled RH
User Defined High Limit	72	Based upon known conditions	Known conditions
User Defined Low Limit	72	Based upon known conditions	Known conditions
User Defined Cycle	72	Based upon known conditions	Known conditions

NOTE: Conditioning of the test specimen is optional in the overall Test Sequences, but is required before the start of the Optional Vibration Under Low Pressure Test Block. See Test Blocks 2 and 8.

Before You
Begin
Shock Testing

Catching or Restraining Packaged-Products After Free-Fall Drop Testing

Refer to *Guidelines for Selecting and Using ISTA Test Procedures and Projects* for recommendations, cautions, and documentation requirements.

Before You
Begin
Vibration
Under
Dynamic Load

CAUTION:

A restraining device or devices (fixturing) shall be used with the vibration test system to:

- Prevent the Top-Load from moving off the package being tested **and**
- Prevent the test specimen from moving off the platform **and**
- Maintain test orientation of the stack, **but**
- The device or devices shall not restrict the vertical motion of the test specimen during the test.

CAUTION:

When using weights and a load spreader use extreme caution to prevent injury during stacking, testing and removal.

Number of axes and package orientations to be tested:

Type of Package	Number of Axes to Test	Orientations to Test	Dynamic Top-Load Range
Standard	3	3	11 kg – 140 kg (25 lb – 300 lb)
Small in Bag	1	2	36 kg (80 lb)
Flat	3	3	11 kg – 140 kg (25 lb – 300 lb)
Elongated	3	3	11 kg – 140 kg (25 lb – 300 lb)
Unpackaged Pail or Short Cylinder	2	2	11 kg – 140 kg (25 lb – 300 lb)

Dynamic Top-Load Bag – Small

A Consolidation Bag as described in Equipment Required Additional.

Sample Bag with Test Specimen - Small

Randomly fill the second Consolidation Bag, or equivalent, approximately one-half full of the filled dunnage packages described in the table found in the Vibration Equipment section, pack the test specimen into the middle of the bag and then insert the remaining dunnage packages into the bag to simulate a typical pack.

The **Top-Load** is to simulate the effect of 100 kg/m³ (6 lb/ft³ - 0.0035 lb/in³) of assorted freight on top of a floor loaded shipping unit in an over-the-road trailer with an inside height of 2.7 m (108 in).

The **Loading Factor** has been determined by empirical testing that resulted in correlation between damage in the test lab and damage in the field.

Before You
Begin
Top-Load
Apparatus

The Top-Load Apparatus for STANDARD, FLAT and ELONGATED package-types shall be: (see Figure below for example of Top-Load Apparatus)

- A fiberboard box, or other container, of sufficient strength and ability to hold a load spreader (such as a 3/4" piece of plywood or a plate of steel that is the same length and width as the inside dimensions of the load apparatus) and required weight for each axis **and**
- The length and width dimensions of the Top-Load package or apparatus which will be applied to the test specimen shall each be a minimum of 50 mm (2 in) longer than each of the two dimensions of the test specimen's top face when positioned for testing [i.e., a minimum of 25 mm (1 in) overhang on each side] **but**
- The length and width dimensions of the Top-Load package or apparatus may each be longer by a maximum of 150 mm (6 in) than each of the two dimensions of the test specimen's top face when positioned for testing [i.e., a maximum of 75 mm (3 in) overhang on each side] **and**
- Some means of adding additional weight so that the Top-Load (TL) is distributed evenly over the entire inside face area of the Top-Load apparatus that will apply the Top-Load to the entire top face of the test specimen when it's positioned for testing **and**
- Adequate void fill that shall securely hold the weight in place to prevent the weight from moving or bouncing within the top-load apparatus (it is also required to use stretch wrap around the test specimen and the top-load apparatus to prevent the top-load apparatus from bouncing on top of the test specimen) **and**
- The top-load apparatus shall never be smaller than the test face; the calculated weight must cover the entire surface of the test face during the testing.

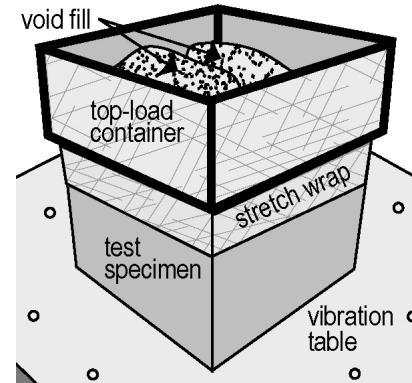

Top-Load Apparatus for UNPACKAGED PAILS and SHORT CYLINDERS. For the testing of unpackaged pails and short cylinders, an additional top-load apparatus is required as follows:

- A pail or short cylinder which is identical or essentially identical to the test item, **and**
- Fitted with a load spreader on the bottom (such as a 3/4" piece of plywood or a plate of steel that's the same size and shape as the inside bottom surface), **and**
- Some means of adding weight so that the Top-Load (TL) is distributed evenly over the entire inside bottom area, **and**
- Adequate void fill to securely hold the weight in place to prevent it from moving or bouncing within the top-load apparatus.
- It is also recommended to use stretch wrap around the test specimen and the top-load apparatus to prevent the top-load apparatus from bouncing on top of the test specimen.

Top-Load Apparatus for SMALLS:

- A large Consolidation Bag, approximately 1.0 x 0.7 m (39 x 27 in), made of canvas, polyolefin film/fabric, or similar strong flexible material, and with a zipper or other suitable closure at one end. The bag shall have sufficient capacity and strength to meet the weight requirements here, and the performance requirements of Test Block 6 (Vibration for Small). The bag shall be filled with 36 kg (80 lb) of sand, or other dense, flowable material, suitably packaged in smaller bags.

Determination of Top-Load Weight:

- Determine the proper top-load weight for Standard, Flat, and Elongated packaged-product types, and for Unpackaged Pails and Short Cylinders, by first using the "Top-Load Formulas TL" chart at the top of page 14, then following instructions in the "Top-Load weight (TL) for any Axis" table at the bottom of page 14 to determine the specified Top-Load. A tolerance of $\pm 3\%$ is allowed for this specified Top-Load.
- The Top-Load Weight required for Smalls is 36 kg. (80 lb) $\pm 5\%$.

Continued on next page

Continued from previous page

Familiarity with the following formulas is required:

Note: Dimension for “Top-Load Formulas TL” are based upon the packaged-product being in the most stable orientation which could be different than the intended shipping orientation.

Top-Load Formulas TL		Metric Units (m and kg)	English Units (in and lb)
Top-Load (TL–H) with face 3 down		$(2.7 - H) \times L \times W \times 100$	$(108 - H) \times L \times W \times 0.0035$
Top-Load (TL–W) with face 4 down		$(2.7 - W) \times L \times H \times 100$	$(108 - W) \times L \times H \times 0.0035$
Top-Load (TL–L) with face 6 down		$(2.7 - L) \times W \times H \times 100$	$(108 - L) \times W \times H \times 0.0035$
Where	Represents		
TL	Total Weight of the Top-Load Apparatus	Kilograms (kg)	Pounds (lb)
2.7 and 108	Height of typical trailer	Meters (m)	Inches (in)
H	Height of shipping unit	Meters (m)	Inches (in)
L	Length of shipping unit	Meters (m)	Inches (in)
W	Width of shipping unit	Meters (m)	Inches (in)
100 and 0.0035	Loading Factor: 50% of the average density of freight*	100 kg/m ³	0.0035 lb/in ³

Determine the Top-Load weight using the following table:

Top-Load weight (TL) for any Axis	
Determine the Top-Load weight to be used for each axis by comparing the calculated TL against the following statements.	
IF the calculated Top-Load for an axis is ...	THEN ...
Less than 11kg (25 lb)	Do not use a Top-Load during vibration testing.
11 kg (25 lb) to 140 kg (300 lb)	Use the calculated Top-Load (TL) rounded up to the next closest increment of 2 kg (5 lb) for that axis. <i>Examples:</i> If the calculated Top-Load is 21 kg you would round up and use 22 kg as the Top-Load; If the calculated Top-Load is 32 lb you would round up and use 35 lb as the Top-Load.
Greater than 140 kg (300 lb)	Use 140 kg (300 lb) as the Top-Load (TL).

* The **Loading Factor** has been determined by empirical testing that resulted in correlation between damage in the test lab and damage in the field.

OVER-THE-ROAD TRAILER SIMULATION

The following breakpoints are for an Over-the-Road trailer typical for parcel delivery movement and shall be programmed into the vibration controller to produce the acceleration versus frequency profile (spectrum) with an overall G_{rms} level of 0.53 (see below). The theoretical stroke required to run this vibration profile is 47.12 mm (1.855 in) peak to peak:

Frequency (Hz)	PSD Level, g^2/Hz
1.0	0.0007
3.0	0.02
5.0	0.02
7.0	0.001
12.0	0.001
15.0	0.004
24.0	0.004
28.0	0.001
36.0	0.001
42.0	0.003
75.0	0.003
200.0	0.000004

ISTA 3A - Over-the-Road Trailer Spectrum

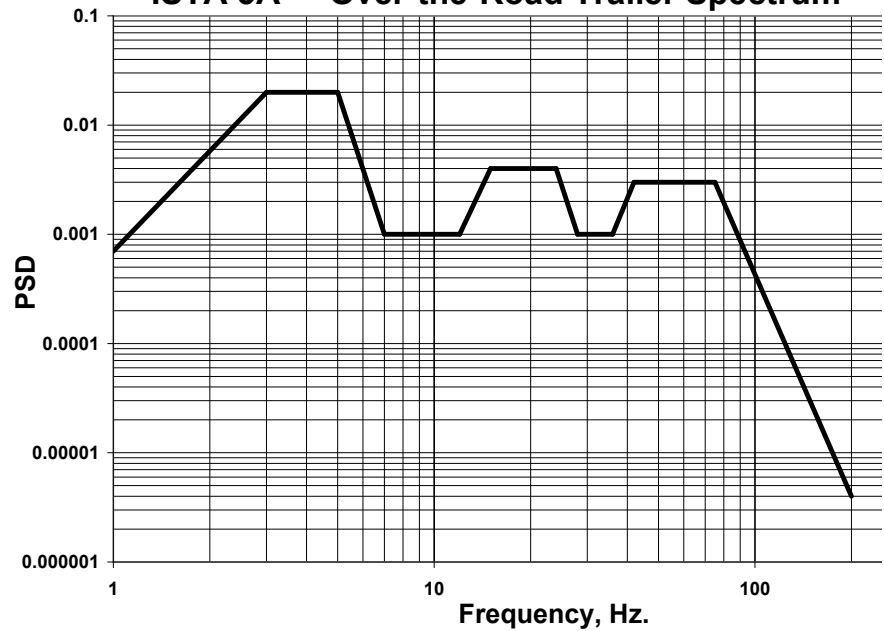

PICK-UP AND DELIVERY VEHICLE SIMULATION

The following breakpoints are for a pick-up and delivery vehicle and shall be programmed into the vibration controller to produce the acceleration versus frequency profile (spectrum) with an overall G_{rms} level of 0.46 (see below). The theoretical stroke required to run this vibration profile is 58.72 mm (2.312 in) peak to peak:

Frequency (Hz)	PSD Level, g^2/Hz
1.0	0.001
3.0	0.035
4.0	0.035
7.0	0.0003
13.0	0.0003
15.0	0.001
24.0	0.001
29.0	0.0001
50.0	0.0001
70.0	0.002
100.0	0.002
200.0	0.00005

ISTA 3A - Pick-up and Delivery Vehicle Spectrum

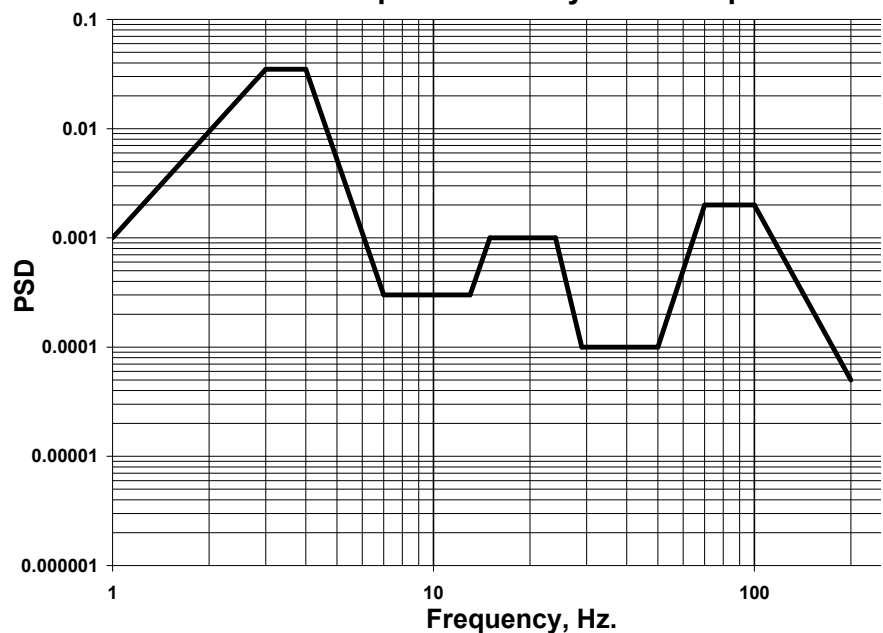

Determine the Low Pressure using the following Table:

IF the Test Specimen will be shipped via ...	THEN ...
Truck <u>Only</u>	Use an absolute pressure of 70 kPa (10 psi) [approximate altitude equivalent of 3000 m (10,000 ft)]
Truck and Air	Use an absolute pressure of 60 kPa (8.7 psi) [approximate altitude equivalent of 4250 m (14,000 ft)]

NOTE: There are two ways of measuring pressure, **absolute pressure** or **gage pressure**. Both measure pressure in kilopascals (kPa) or pounds per square inch (psi). Absolute pressure is measured relative to absolute zero pressure. Gage pressure uses atmospheric pressure (101.3 kPa, 14.7 psi) as a zero reference.

Examples:

Given a gage pressure reading, calculate absolute pressure as follows:

$$\text{Absolute pressure} = \text{gage pressure reading} + \text{atmospheric pressure [101.3 kPa (14.7 psi)]}$$

Gage pressure readings for low pressures (altitudes above sea level) are negative:

$$\text{Gage pressure} = \text{absolute pressure} - \text{atmospheric pressure [101.3 kPa (14.7 psi)]}$$

The following Table shows pressure conversions:

Metric Units				English Units			
Altitude Above Sea Level	Barometric Reading	Absolute Pressure	Gage Pressure	Altitude Above Sea Level	Barometric Reading	Absolute Pressure	Gage Pressure
Meters (m)	mm Hg (torr)	kPa	kPa	Feet (ft)	in Hg	psi	psi
0	760	101.3	0	0	29.92	14.7	0
3,048	522.84	69.7	-31.6*	10,000	20.6	10.11	-4.59*
4,267	446.33	59.5	-41.8*	14,000	17.57	8.63	-6.07*

*Negative gage pressures are sometimes referred to as "vacuum kPa" or "vacuum psi".

SPECTRUM FOR OPTIONAL RANDOM VIBRATION UNDER LOW PRESSURE

The spectrum described here is for use in Test Block 8 – OPTIONAL Random Vibration Under Low Pressure. In combination with the required low pressures, it has been shown to replicate certain leakage failures encountered in low pressure (altitude) environments. The spectrum shall be programmed into the vibration controller to produce an acceleration-versus-frequency profile with an overall level of 1.05 G_{rms}. The theoretical stroke required to run this vibration profile is 7.52 mm (0.296 in) peak to peak.

This spectrum is to be used for Vibration Under Low Pressure only.

Frequency (Hz)	PSD Level, g ² /Hz
2.0	0.0002
12.0	0.01
100.0	0.01
300.0	0.00001

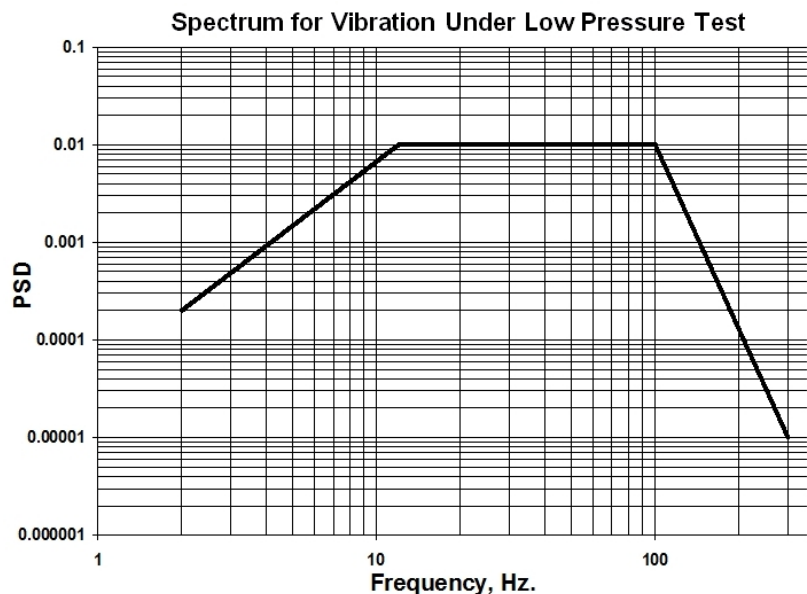

TEST BLOCK 1
Atmospheric
Conditioning

The test blocks that follow contain tables that indicate the required steps for each test in the procedure.

TEMPERATURE AND HUMIDITY	
Step	Action
1	PRE-CONDITIONING: The packaged-product should be stored at laboratory ambient temperature and humidity for twelve (12) hours prior to testing.
2	Is optional conditioning going to be performed? <ul style="list-style-type: none"> • If Yes, go to Step 6. • If No, go to the next Step.
3	Record the ambient laboratory temperature and humidity when testing starts.
4	At the end of testing record temperature and humidity.
5	Go to TEST BLOCK 3 (Shock: First Sequence – Drop).
6	Select an anticipated condition from Before You Begin Atmospheric Conditioning.
7	Check the conditioning apparatus to insure that the temperature and humidity are at the required levels.
8	Place the packaged-product in the conditioning apparatus.
9	At the completion of the required conditioning time remove the packaged-product from the conditioning apparatus.
10	Conditioning is now complete. When testing starts, record the ambient temperature and humidity. Go to TEST BLOCK 3 (Shock: First Sequence – Drop) and perform the remaining test sequence as quickly as possible.

TEST BLOCK 2
OPTIONAL
Atmospheric
Conditioning
for Vibration
Under Low
Pressure

TEMPERATURE AND HUMIDITY FOR VIBRATION UNDER LOW PRESSURE	
Step	Action
1	Set the temperature and humidity according to the Controlled Conditions values in Before You Begin Atmospheric Conditioning [23°C (73°F) and 50% RH].
2	Check the conditioning apparatus to insure that the temperature and humidity are at the required levels.
3	Place the packaged-product in the conditioning apparatus.
4	At the completion of the required conditioning (8 hours) remove the packaged-product from the conditioning apparatus.
5	Record the ambient laboratory temperature and humidity when testing starts. Go to TEST BLOCK 8 (Vibration Under Low Pressure) Step 2 and perform the remaining test sequence as quickly as possible.

3A

TEST SEQUENCE FOR PROCEDURE 3A

TEST BLOCK 3
Shock:
First Sequence
(Drop)

For STANDARD,
SMALL,
FLAT and
ELONGATED

SHOCK - DROP					
Complete the following test sequence for each type of package that has a check in the box: <input checked="" type="checkbox"/> Standard <input checked="" type="checkbox"/> Small (DO NOT test in bag) <input checked="" type="checkbox"/> Flat <input checked="" type="checkbox"/> Elongated					
Step	Action				
1	Follow the table below to determine the height and orientation for the first 9 drops.				
	Drop Number	< 32 kg (70 lb)	32-70 kg (70-150 lb)	Standard, Flat, Elongated, Small (not in bag)	Two-Dimensional Envelopes and Mailers (not in bag)
	1	460 mm (18 in)	300 mm (12 in)	Edge 3-4	Edge 4
	2	460 mm (18 in)	300 mm (12 in)	Edge 3-6	Edge 6
	3	460 mm (18 in)	300 mm (12 in)	Edge 4-6	Edge 5
	4	460 mm (18 in)	300 mm (12 in)	Corner 3-4-6	Corner 4-6
	5	460 mm (18 in)	300 mm (12 in)	Corner 2-3-5	Corner 2-5
	6	460 mm (18 in)	300 mm (12 in)	Edge 2-3	Edge 2
	7	460 mm (18 in)	300 mm (12 in)	Edge 1-2	Edge 5
	8	910 mm (36 in)	600 mm (24 in)	Face 3	Face 3
	9	460 mm (18 in)	300 mm (12 in)	Face 3	Face 1
2	Shock test is now complete. Go to TEST BLOCK 4 (Vibration Under Dynamic Load).				

3A

TEST SEQUENCE FOR PROCEDURE 3A

TEST BLOCK 4
Vibration Under
Dynamic Load
(Over-The-Road
spectrum)

For STANDARD,
FLAT and
ELONGATED

VIBRATION - DYNAMIC LOAD, RANDOM (using OVER-THE-ROAD spectrum)			
Complete the following test sequence for each type of package that has a check in the box: <input checked="" type="checkbox"/> Standard <input type="checkbox"/> Small <input checked="" type="checkbox"/> Flat <input checked="" type="checkbox"/> Elongated			
Step	Action	Testing Orientation	Vibration Duration
	IF the test specimen is...	THEN...	
1	An unpackaged pail or short cylinder (not in a box or other outer container)	Go to TEST BLOCK 5 (Vibration for Unpackaged Pails and Short Cylinders).	
	Small	Go to TEST BLOCK 6 (Vibration – Over-the-Road).	
	Standard, Flat or Elongated	Go to Step 2.	
2	Place the packaged-product on the vibration table so that face-3 rests on the center of the platform.	FACE 3 on table surface	60 MINUTES
3	Place the Dynamic Top-Load apparatus as determined in Before You Begin Vibration Under Dynamic Load for TL-H on top of the test specimen.*		
4	Using some form of column stack fixturing, make sure that the stack will maintain its orientation without restricting the vertical motion of the Top-Load apparatus or the test specimen.		
5	Start the vibration machine to produce the Over-the-Road random vibration spectrum indicated in Before You Begin Vibration Testing.		
6	After 60 minutes, stop the vibration testing and remove the Dynamic Top-Load apparatus.		
7	Rotate the test specimen so that face-4 rests on the center of the vibration table platform.	FACE 4 on table surface	30 MINUTES
8	Place the Dynamic Top-Load apparatus as determined in Before You Begin Vibration Under Dynamic Load Testing for TL-W on top of the test specimen.*		
9	Using some form of column stack fixturing to make sure that the stack maintains its orientation without restricting the vertical motion of the Top- Load apparatus or the test specimen.		
10	Start the vibration machine to produce the Over-the-Road random vibration spectrum indicated in Before You Begin Testing.		
11	After 30 minutes, stop the vibration testing and remove the Dynamic Top-Load apparatus.		

* If the test item is an elongated packaged-product with a non-rectangular cross-section (round tube, triangular tube, etc.), **do not** use a Dynamic Top-Load in the large-face-down orientations.

Continued next page

3A

TEST SEQUENCE FOR PROCEDURE 3A

TEST BLOCK 4
CONTINUED
Vibration Under
Dynamic Load
(Over-The-Road
spectrum)

For STANDARD,
FLAT and
ELONGATED

Continued from previous page

Step	Action	Testing Orientation	Vibration Duration
12	Rotate the test specimen so that face-6 rests on the center of the vibration table platform.	FACE 6 on table surface	30 MINUTES
13	Place the Dynamic Top-Load apparatus as determined in Before You Begin Vibration Under Dynamic Load for TL-L on top of the test specimen.		
14	Using some form of column stack fixturing, make sure that the stack will maintain its orientation without restricting the vertical motion of the Top-Load apparatus or the test specimen.		
15	Start the vibration machine to produce the Over-the-Road random vibration spectrum indicated in Before You Begin Vibration Testing.		
16	After the completion of 30 minutes, stop the vibration testing and remove the Dynamic Top-Load apparatus.		
17	This vibration testing is complete. Go to TEST BLOCK 7 (Vibration – Pick-Up and Delivery).		

3A

TEST SEQUENCE FOR PROCEDURE 3A

TEST BLOCK 5
Vibration Under
Dynamic Load
(Over-The-Road
spectrum)

For
UNPACKAGED
PAILS and
SHORT
CYLINDERS

VIBRATION - DYNAMIC LOAD – RANDOM (using OVER-THE-ROAD spectrum)			
Complete the following test sequence <i>only</i> for unpackaged pails and short cylinders (not in a box or other outer container)			
STEP	ACTION	TESTING ORIENTATION	VIBRATION DURATION
1	Place the packaged-product on the center of the vibration table so that face-3 rests on the platform.	FACE 3 on table surface	45 MINUTES
2	Place the Top-Load Apparatus for Unpackaged Pails and Short Cylinders, as described in Before you Begin Vibration Under Dynamic Load for TL-H, on the test specimen such that it nests on top of the test specimen.		
3	Using some form of column stack fixturing, make sure that the stack will maintain its orientation without restricting the vertical motion of the Top-Load apparatus or the test specimen.		
4	Start the vibration machine to produce the Over-the-Road random vibration spectrum indicated in Before You Begin Vibration Testing.		
5	After 45 minutes, stop the vibration testing and remove the Dynamic Top-Load apparatus.		
6	Place the Dynamic Top-Load apparatus (fiberboard box with load spreader and weights), as described in Before You Begin Vibration Under Dynamic Load for TL-H, on top of the test specimen.	FACE 3 on table surface	45 MINUTES
7	Using some form of column stack fixturing to make sure that the stack maintains its orientation without restricting the vertical motion of the Top- Load apparatus or the test specimen.		
8	Start the vibration machine to produce the Over-the-Road random vibration spectrum indicated in Before You Begin Vibration Testing.		
9	After 45 minutes, stop the vibration testing and remove the Dynamic Top-Load apparatus.		
10	Rotate the test specimen to place it on its side, so that sidewall line 2-6 rests on the center of the vibration table platform.	SIDEWALL LINE 2-6 on table surface	30 MINUTES
11	Do not place a Dynamic Top-Load apparatus on top of the test specimen.		
12	Start the vibration machine to produce the Over-the-Road random vibration spectrum indicated in Before You Begin Vibration Under Dynamic Load.		
13	After the completion of 30 minutes, stop the vibration testing.		
14	This vibration testing is complete. Go to TEST BLOCK 7 (Vibration – Pick-up and Delivery Vehicle).		

3A

TEST BLOCK 6
Vibration
(Under Dynamic
Load
Over-the-Road
spectrum)

For SMALL

TEST SEQUENCE FOR PROCEDURE 3A

VIBRATION - DYNAMIC LOAD AND RANDOM (using OVER-THE-ROAD spectrum)			
Complete the following test sequence for each type of package that has a check in the box: <input type="checkbox"/> Standard <input checked="" type="checkbox"/> Small (test IN bag) <input type="checkbox"/> Flat <input type="checkbox"/> Elongated			
STEP	ACTION	TESTING ORIENTATION	VIBRATION DURATION
1	Place the specimen bag on the center of the vibration table with face 1 in the down orientation.	FACE 1 on table surface	30 MINUTES
2	Place the Top Load bag filled with 36 kg (80 lb) of sand or other dense, flowable material, on top of the test specimen.		
3	Start the vibration machine to produce the Over-the-Road random vibration spectrum indicated in Before You Begin Vibration Testing.		
4	Stop the vibration machine at the completion of 30 minutes.		
5	Turn the bag over so that face 2 is in the down orientation.	FACE 2 on table surface	30 MINUTES
6	Place the Top Load bag filled with 36 kg (80 lb) of sand or other dense, flowable material, on top of the test specimen.		
7	Start the vibration machine to produce the Over-the-Road random vibration spectrum indicated in Before You Begin Vibration Testing.		
8	Stop the vibration testing at the end of 30 minutes.		
9	Vibration testing is now complete. Go to TEST BLOCK 7 (Vibration – Pick-Up and Delivery).		

TEST BLOCK 7
Vibration
(Random
Pick-up and
Delivery Vehicle)

For STANDARD,
SMALL,
FLAT and
ELONGATED

VIBRATION - RANDOM (using PICK-UP AND DELIVERY VEHICLE spectrum)			
Complete the following test sequence for each type of package that has a check in the box: <input checked="" type="checkbox"/> Standard <input checked="" type="checkbox"/> Small (DO NOT test in bag) <input checked="" type="checkbox"/> Flat <input checked="" type="checkbox"/> Elongated			
STEP	ACTION	TESTING ORIENTATION	VIBRATION DURATION
1	Place the packaged-product on the center of the vibration table so that face-3 rests on the platform.	FACE 3 on table surface	30 MINUTES
2	Do not place a Dynamic Top-Load apparatus on top of the test specimen.		
3	Start the vibration machine to produce the Pick-Up and Delivery Vehicle random vibration spectrum indicated in Before You Begin Vibration Testing.		
4	After the completion of 30 minutes, stop the vibration testing.		
5	Testing is complete. Determine the next TEST BLOCK to be used:		
	IF you choose...	THEN ...	
	To conduct the Optional Vibration under Low Pressure testing.	Go to TEST BLOCK 8 (Vibration Under Low Pressure).	
	Not to conduct the Optional Vibration under Low Pressure testing.	Vibration testing is complete. Go to TEST BLOCK 9 (Shock – Drop).	

3A

TEST SEQUENCE FOR PROCEDURE 3A

TEST BLOCK 8
OPTIONAL
Vibration Under
Low Pressure

For STANDARD,
SMALL,
FLAT and
ELONGATED

VIBRATION – OPTIONAL LOW PRESSURE AND RANDOM (using OVER-THE-ROAD and OPTIONAL RANDOM VIBRATION UNDER LOW PRESSURE spectra as applicable)				
NOTE: THIS TEST BLOCK IS OPTIONAL. Complete the following test sequence for each type of package that has a check in the box:				
	<input checked="" type="checkbox"/> Standard	<input checked="" type="checkbox"/> Small (DO NOT test in bag)	<input checked="" type="checkbox"/> Flat	<input checked="" type="checkbox"/> Elongated
STEP	ACTION		TESTING ORIENTATION	VIBRATION DURATION
1	Go to TEST BLOCK 2 (Temperature and Humidity for Vibration Under Low Pressure) for conditioning prior to conducting this vibration test.			
2	Place test specimen so that face-6 rests in the center of the bottom surface of the low pressure (altitude) chamber. Do not place a Dynamic Top-Load package on top of the test specimen.		FACE 6 on table surface [For two-dimensional envelopes and mailers (not in bag), place FACE 3 on table surface]	60 MINUTES
3	Place the low pressure (altitude) chamber on the vibration table platform and seal it.			
4	Turn the chamber on and adjust it to reduce the pressure at a rate of 305 m (1000 ft) per 30-60 seconds. Stop and hold at an absolute pressure of 70 kPa (10 psi), approximately equal to an altitude equivalent of 3000 m (10,000 ft).			
5	Maintain the reduced pressure, start the vibration machine to produce the Spectrum for Over-The-Road random vibration indicated in Before You Begin Vibration Testing.			
6	Stop the vibration testing after the completion of 60 minutes.			
7	Release the low pressure at a rate of 305 m (1000 ft) per 30-60 seconds. Then remove the chamber from the vibration platform and the test specimen from the chamber.			
8	IF the Test Specimen will be shipped via ...		THEN ...	
	Truck <u>Only</u> [The low pressure used above is similar to that which might be encountered on high-altitude roads]		Vibration testing is now complete. Go TEST BLOCK 9 (Shock: Second Sequence – Drop)	
	Air [Air transport may involve even lower pressures (higher altitudes). Because air shipments typically involve some truck transport, the following test is <i>in addition to</i> the test above]		Go to Step 9.	
9	Place test specimen so that face-6 rests in the center of the bottom surface of the low pressure (altitude) chamber. Do not place a Dynamic Top-Load package on top of the test specimen		FACE 6 on table surface [For two-dimensional envelopes and mailers (not in bag), place FACE 3 on table surface]	60 MINUTES
10	Place the low pressure (altitude) chamber on the vibration table platform and seal it.			
11	Turn the chamber on and adjust it to reduce the pressure at a rate of 305 m (1000 ft) per 30-60 seconds. Stop and hold at an absolute pressure of 60 kPa (8.7 psi) approximately equal to an altitude of 4200 m (14,000 ft.)			
12	Maintain the reduced pressure, start the vibration machine to produce the spectrum for Optional Random Vibration Under Low Pressure as indicated in Before You Begin Vibration Under Low Pressure.			
13	Stop the vibration testing after the completion of 60 minutes.			
14	Release the low pressure at a rate of 305 m (1000 ft) per 30-60 seconds. Then remove the chamber from the vibration platform and the test specimen from the chamber.			
15	Vibration testing is now complete. Go to TEST BLOCK 9 (Shock – Drop).			

3A

TEST SEQUENCE FOR PROCEDURE 3A

TEST BLOCK 9
Shock:
Second
Sequence
(Drop)

For STANDARD,
SMALL,
FLAT and
ELONGATED

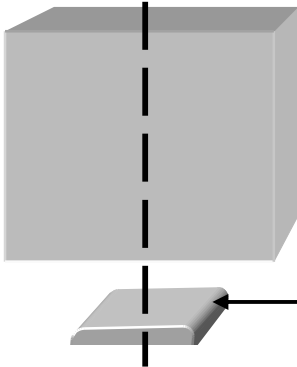
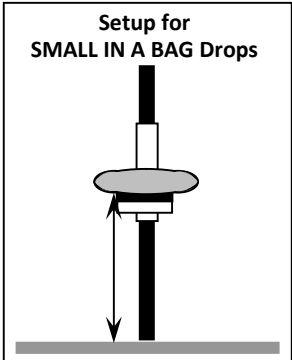
SHOCK - DROP						
Complete the following test sequence for each type of package that has a check in the box: <input checked="" type="checkbox"/> Standard <input checked="" type="checkbox"/> Small (test IN bag) <input checked="" type="checkbox"/> Flat <input checked="" type="checkbox"/> Elongated						
STEP	ACTION					
1	Follow the table below to determine the height and orientation for the final set of 8 drops for Standard packages and 7 drops for Small packages in a bag.					
	Drop Number	Drop Height			Test Specimen	
		< 32 kg (70 lb)	32-70 kg (70-150 lb)	Small (in a bag)	Standard, Flat, Elongated	Small (in a bag)
	10	460 mm (18 in)	300 mm (12 in)	610 mm (24 in)	Edge 3-4	Face 4
	11	460 mm (18 in)	300 mm (12 in)	610 mm (24 in)	Edge 3-6	Face 1
	12	460 mm (18 in)	300 mm (12 in)	610 mm (24 in)	Edge 1-5	Face 2
	13	460 mm (18 in)	300 mm (12 in)	610 mm (24 in)	Corner 3-4-6	Face 3
	14	460 mm (18 in)	300 mm (12 in)	610 mm (24 in)	Corner 1-2-6	Face 1
	15	460 mm (18 in)	300 mm (12 in)	610 mm (24 in)	Corner 1-4-5	Face 2
	16	910 mm (36 in)	600 mm (24 in)	610 mm (24 in)	Most critical or damage-prone flat orientation	Face 4
	17	460 mm (18 in)	300 mm (12 in)	NA	Standard: Face 3 on hazard Flat or Elongated: Face 2 on hazard	NA
	<p>For drop 17, the test specimen should strike the hazard midpoint across the longest dimension of the face and parallel to the shortest dimension of the face being impacted. The required drop distance is to the impact surface, not to the hazard. The diagram below shows this concept:</p>					
						
			Hazard parallel to the shortest dimension of face 3 OR face 2			
2	IF the test specimen type is:			THEN:		
	Standard or Small and Does NOT Contain Liquids			All testing is now complete. Go to the Reporting an ISTA Test section at the end of this Procedure.		
	Standard or Small and Contains Liquids			This Shock test is complete. Go to TEST BLOCK 14 (Integrity – Leak Test).		
	Flat or Elongated			This Shock test is complete. Go to TEST BLOCK 10 (Shock – Rotational Edge Drop).		

3A

TEST SEQUENCE FOR PROCEDURE 3A

TEST BLOCK 10
Shock
(Rotational
Edge Drop)

For FLAT and
ELONGATED

SHOCK - ROTATIONAL EDGE DROP			
Complete the following test sequence for each type of package that has a check in the box: <input type="checkbox"/> Standard <input type="checkbox"/> Small <input checked="" type="checkbox"/> Flat <input checked="" type="checkbox"/> Elongated			
STEP	ACTION		
1	Perform three rotational edge drops according to the sequence in the table below.		
	Sequence #	Orientation	Specific edge
	1	Edge	One of the longest face 3 edges
	2	Edge	next longest edge radiating 90° from the edge just tested
	3	Edge	The opposite edge tested in Sequence 2.
2	Place the package with face 3 down onto a flat, rigid surface such as steel or concrete.		
3	Support the face 3 edge that is opposite the face 3 edge that is to be tested with a timber or support 90 to 100 mm (3.5 to 4.0 in) in height and width.		
4	Lift the face 3 edge that is to be tested according to sequence in Step 1 to 200 mm (8 in) off the surface.		
5	Release the edge that is to be tested so that it falls freely onto a flat, rigid surface.		
6	Repeat Step 3 through Step 5 to complete additional edge drops according to the sequence in Step 1.		
7	Testing is complete. Go to TEST BLOCK 11 (Shock – Full Rotational Flat Drop).		

TEST BLOCK 11
Shock
(Full Rotational
Flat Drop)

For FLAT and
ELONGATED

SHOCK - FULL ROTATIONAL FLAT DROP		
Complete the following test sequence for each type of package that has a check in the box: <input type="checkbox"/> Standard <input type="checkbox"/> Small <input checked="" type="checkbox"/> Flat <input checked="" type="checkbox"/> Elongated		
STEP	ACTION	
1	Place the packaged-product so that one of the smallest faces rests on a rigid surface such as steel or concrete and in a position that when pushed over the face 3 surface will impact the rigid surface.	
2	Using any method apply just enough force to the upper half of face 1 to push over the packaged-product without moving the packaged-product from its position.	
3	Place the packaged-product so that one of the next largest faces rests on a rigid surface such as steel or concrete and in a position that when pushed over the face 3 surface will impact the rigid surface.	
4	Using any method apply just enough force to the upper half of face 1 to push over the packaged-product without moving the packaged-product from its position.	
5	Determine the next Shock Test according to the following table:	
	IF the test specimen type is ...	THEN ...
	Flat	Go to TEST BLOCK 12 (Shock – Concentrated Impact).
	Elongated	Go to TEST BLOCK 13 (Shock – Bridge Impact).

3A

TEST BLOCK 12
Shock
(Concentrated Impact)

For FLAT

TEST SEQUENCE FOR PROCEDURE 3A

SHOCK - CONCENTRATED IMPACT							
Complete the following test sequence for each type of package that has a check in the box: <input type="checkbox"/> Standard <input type="checkbox"/> Small <input checked="" type="checkbox"/> Flat <input type="checkbox"/> Elongated							
STEP	ACTION						
1	Place the packaged-product so that face 3 rests on a rigid surface such as steel or concrete.						
2	Draw a line parallel to the longest dimension of face 1 and across midpoint of the longest dimension of face 1. Mark the midpoint of the line across the shortest dimension of face 1.						
3	Mark the midpoint of a bottom edge of the hazard box that has the angle iron attached. Tape a string to this point that measures 400 mm (16 in) from the midpoint of the bottom edge of the hazard box to the other end of the string.						
4	Hold the hazard box so that the angle iron bottom edge with the string attached is parallel to the shortest dimension of face 1 and the string just touches the midpoint of face 1. The diagram below shows this concept: <div style="text-align: center;"> </div>						
5	Drop the hazard box onto the packaged-product without attempting to catch any rebound of the hazard box.						
6	<table border="1" style="width: 100%; border-collapse: collapse;"> <tr> <th style="width: 50%;">IF the test specimen:</th> <th style="width: 50%;">THEN:</th> </tr> <tr> <td>Does NOT Contain Liquids</td> <td>All testing is now complete. Go to the Reporting an ISTA Test section at the end of this Procedure.</td> </tr> <tr> <td>Contains Liquids</td> <td>This Shock test is complete. Go to TEST BLOCK 14 (Integrity – Leak Test).</td> </tr> </table>	IF the test specimen:	THEN:	Does NOT Contain Liquids	All testing is now complete. Go to the Reporting an ISTA Test section at the end of this Procedure.	Contains Liquids	This Shock test is complete. Go to TEST BLOCK 14 (Integrity – Leak Test).
	IF the test specimen:	THEN:					
Does NOT Contain Liquids	All testing is now complete. Go to the Reporting an ISTA Test section at the end of this Procedure.						
Contains Liquids	This Shock test is complete. Go to TEST BLOCK 14 (Integrity – Leak Test).						

3A

TEST BLOCK 13
Shock
(Bridge Impact)

For
ELONGATED

TEST SEQUENCE FOR PROCEDURE 3A

SHOCK - BRIDGE IMPACT							
Complete the following test sequence for each type of package that has a check in the box: <input type="checkbox"/> Standard <input type="checkbox"/> Small <input type="checkbox"/> Flat <input checked="" type="checkbox"/> Elongated							
STEP	ACTION						
1	Place the packaged-product so that face 3 rests on two separate support blocks (as described in Equipment Required), which are on opposite ends of the longest dimension parallel to each other and the shortest edges. The midpoint of the packaged-product face 1 shall be directly under the midpoint of the end edge of the drop test platen when in the dropping position.						
2	Set the platen of the drop test machine to drop the hazard box from a height that is 400 mm (16 in) above face 1.						
3	Hold the hazard box on the drop test machine platen so an angle iron bottom edge is parallel the length of the platen and parallel to the shortest dimension of face 1. Drop the hazard box parallel to the shortest dimension of face 1 and impact the midpoint across the longest dimension of face 1.						
4	<table border="1"> <thead> <tr> <th>IF the test specimen:</th> <th>THEN:</th> </tr> </thead> <tbody> <tr> <td>Does NOT Contain Liquids</td> <td>All testing is now complete. Go to the Reporting an ISTA Test section at the end of this Procedure.</td> </tr> <tr> <td>Contains Liquids</td> <td>This Shock test is complete. Go to TEST BLOCK 14 (Integrity – Leak Test).</td> </tr> </tbody> </table>	IF the test specimen:	THEN:	Does NOT Contain Liquids	All testing is now complete. Go to the Reporting an ISTA Test section at the end of this Procedure.	Contains Liquids	This Shock test is complete. Go to TEST BLOCK 14 (Integrity – Leak Test).
IF the test specimen:	THEN:						
Does NOT Contain Liquids	All testing is now complete. Go to the Reporting an ISTA Test section at the end of this Procedure.						
Contains Liquids	This Shock test is complete. Go to TEST BLOCK 14 (Integrity – Leak Test).						

TEST BLOCK 14
Integrity
(Leak Test)

0

INTEGRITY – LEAK TEST		
Complete the following test sequence for each type of package that has a check in the box: <input checked="" type="checkbox"/> Standard <input checked="" type="checkbox"/> Flat <input checked="" type="checkbox"/> Elongated		
STEP	ACTION	EXAMPLE
1	Open the Over Box and remove the TEST SPECIMEN (primary package) that contain liquids.	
2	Place the primary liquid package(s) on their side ensuring that the liquid product is in contact with the closure, challenging the closure's ability to contain the liquid product in the package.	
3	Do not place a top-load on the Test Specimen.	
4	After the completion of eight (8) hours, inspect the primary liquid container for any leakage. Note: If leaking occurs prior to the eight (8) hours being complete, the leak test can be terminated.	
5	All testing is now complete. Go to the Reporting an ISTA Test section at the end of this test.	

ISTA Test Report Forms may be downloaded by members through the online ISTA Member Center (www.ista.org/members/). Custom forms are also acceptable, but information on an official ISTA Report Form is considered to be the minimum required for any test report submission and consideration. Test report forms should be submitted to ISTA Headquarters by mail, fax or electronically. Test reports should be detailed enough for accurate repeatability of the test.

The packaged-product has satisfactorily passed the test if, upon examination, it meets the Product Damage Tolerance and Package Degradation Allowance determined prior to testing.

ISTA Certified Testing Laboratories:

- Should file a test report on all ISTA Test Procedures or Projects conducted.
- Shall file a test report on all ISTA Test Procedures or Projects conducted to obtain Transit Tested Package Certification or Acknowledgement.

To submit a test report form:

- Email to ista@ista.org
- Mail to address shown below
- Fax to +1 517-333-3813.

ISTA Transit Tested Program: Packaged-Product Certification

The ISTA Transit Tested Certification Mark as shown:

- is a registered certification mark **and**
- can only be printed on certified packages **and**
- can only be used by license agreement **and**
- by a Shipper member of the International Safe Transit Association.



When a Shipper member prints this certification mark on a packaged-product, with their manufacturer's license number, they are showing their customer, vendors and carriers that it has passed the requirements of ISTA preshipment testing.

To obtain initial certification of a packaged-product:

- the product manufacturer must be a Shipper member of ISTA in good-standing and with a valid License Agreement on file
- the testing laboratory must be a member of ISTA in good-standing and have a valid lab certification date
- a test report must be submitted by the laboratory to ISTA Headquarters.

In order to maintain its certified status and eligibility for identification with the Transit Tested Certification Mark, each packaged-product must be re-tested whenever a change is made in the:

- Product or
- Process or
- Package.

If corrugated packaging is used, it is recommended that the basis weights of the constituent papers/paperboards be determined after testing and documented to provide the best indicator of equivalence or change.

As a quality control procedure, packaged-products should be re-tested frequently, for example, yearly.

For additional information, refer to *Guidelines for Selecting and Using ISTA Test Procedures and Projects*.

ISTA Membership information is available at www.ista.org.

This Test Procedure is published by:

International Safe Transit Association

1400 Abbot Road, Suite 160, East Lansing, Michigan 48823-1900 USA

© 2018 International Safe Transit Association

No part of the contents of this Test Procedure may be reproduced or transmitted in any form or by any means without the written permission of the publisher.

Order Information: Additional copies of this Test Procedure and the ISTA® RESOURCE BOOK may be ordered online at www.ista.org or by contacting ISTA at (+1) 517.333.3437. A listing of current procedure version dates is available at www.ista.org.