

Tools Recommended

EN_IMPORTANT, RETAIN FOR FUTURE REFERENCE: READ CAREFULLY.

FR_IMPORTANT: A LIRE ATTENTIVEMENT ET À CONSERVER POUR CONSULTATION ULTÉRIEURE.





ES_IMPORTANTE, LEA Y GUARDE PARA FUTURAS REFERENCIAS.

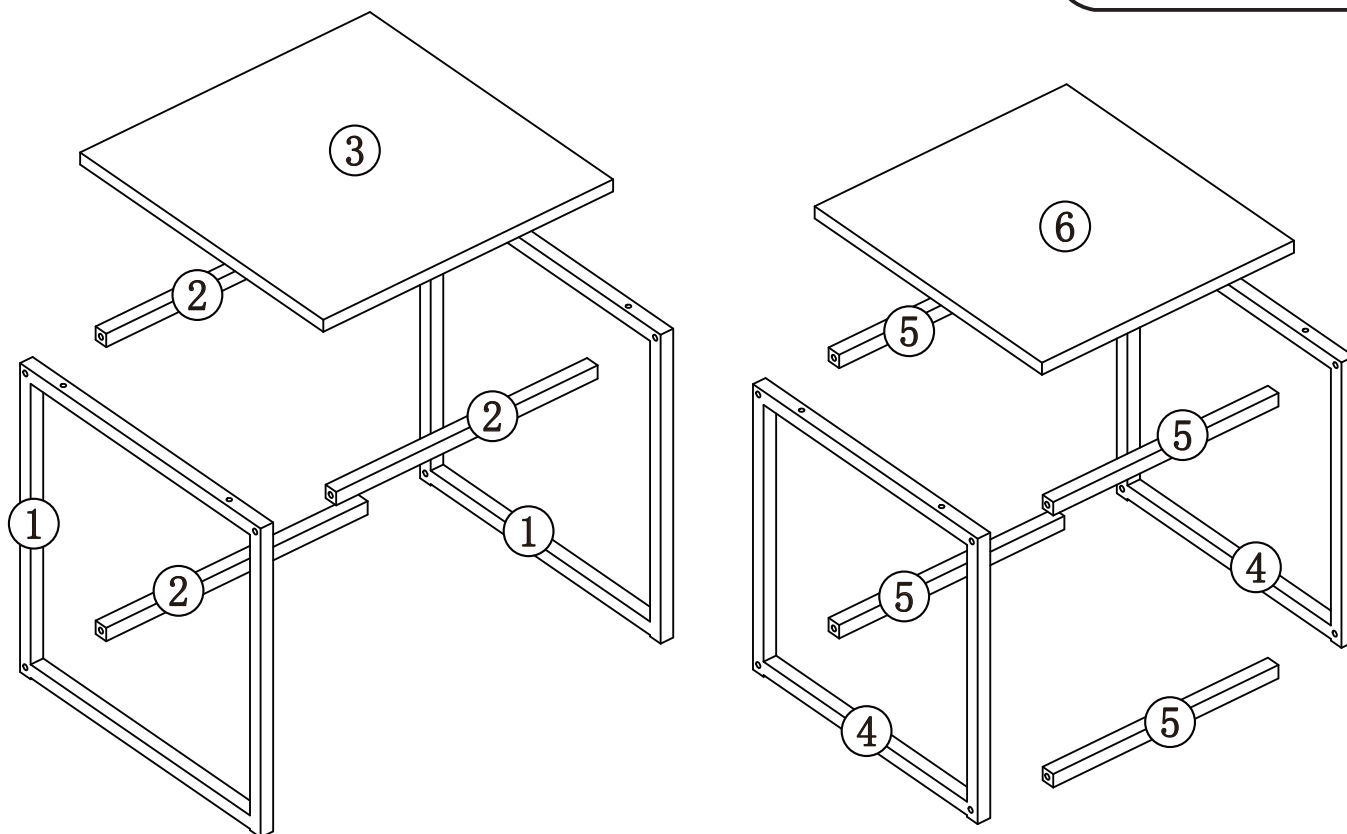

PT_IMPORTANTE, RETER PARA REFERÊNCIA FUTURA: LEIA ATENTAMENTE.

DE_WICHTIG! SORGFÄLTIG LESEN UND FÜR SPÄTER NACHSCHLAGEN AUFBEWAHREN.

IT_IMPORTANTE! CONSERVARE IL PRESENTE MANUALE PER FUTURO RIFERIMENTO E LEGGERLO ATTENTAMENTE.

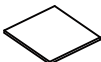
PART
LIST

PART NO.	PARTS	QTY
①		x2
②		x3
③		x1
④		x2
⑤		x4
⑥		x1

PART NO.	PARTS	QTY
Ⓐ	 6x30mm	x 14 +1(spare)
Ⓑ	 6x25mm	x 8
Ⓒ		x 1

EN Do not confuse similar screws.
FR Ne pas confondre des vis similaires.
ES No confunda tornillos similares.
PT Não confundir parafusos semelhantes.
DE Verwechseln Sie ähnliche Schrauben nicht.
IT Non confondere le viti simili.

NOTE

A x14
C x 1

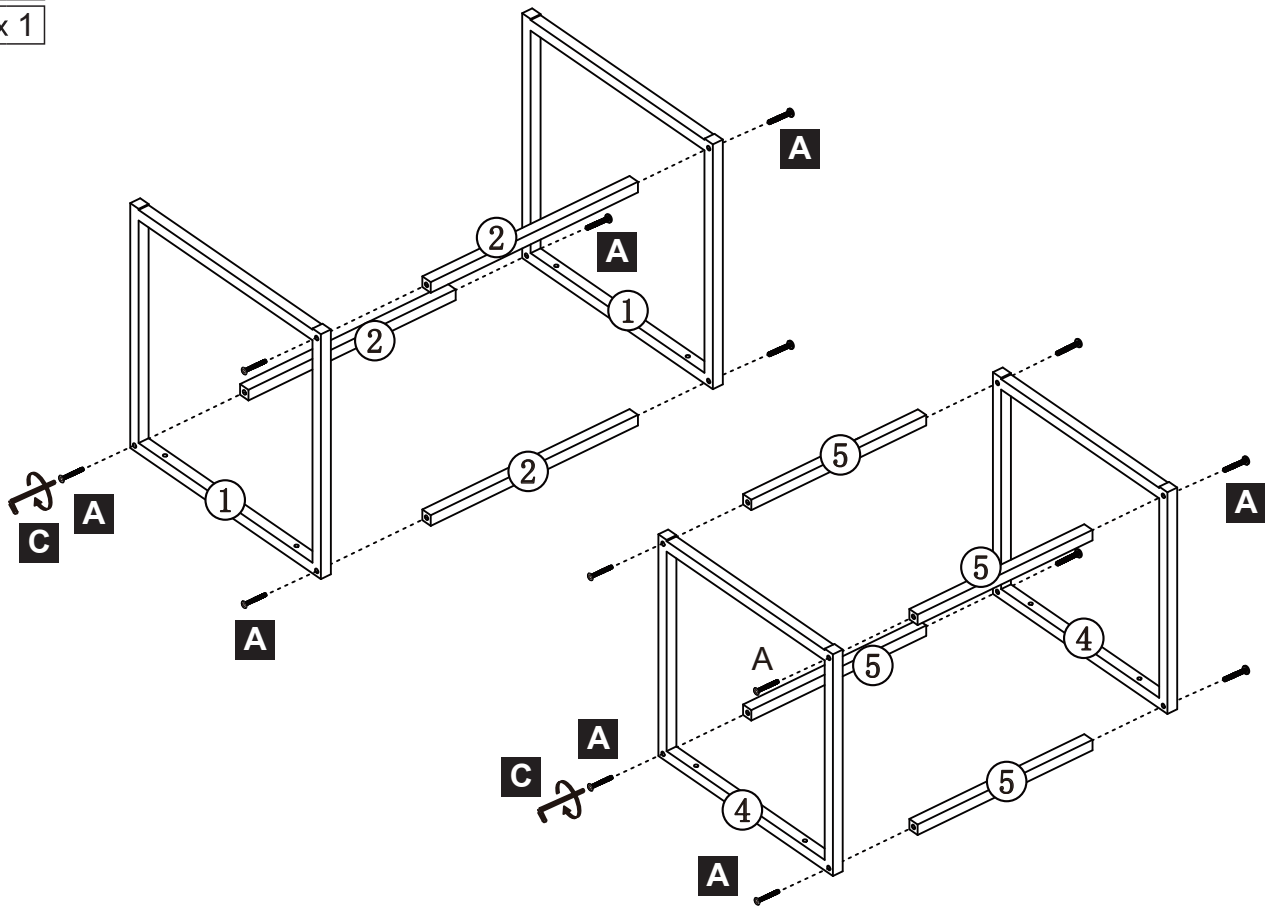

B x 8
C x 1

