

Assembly Instruction

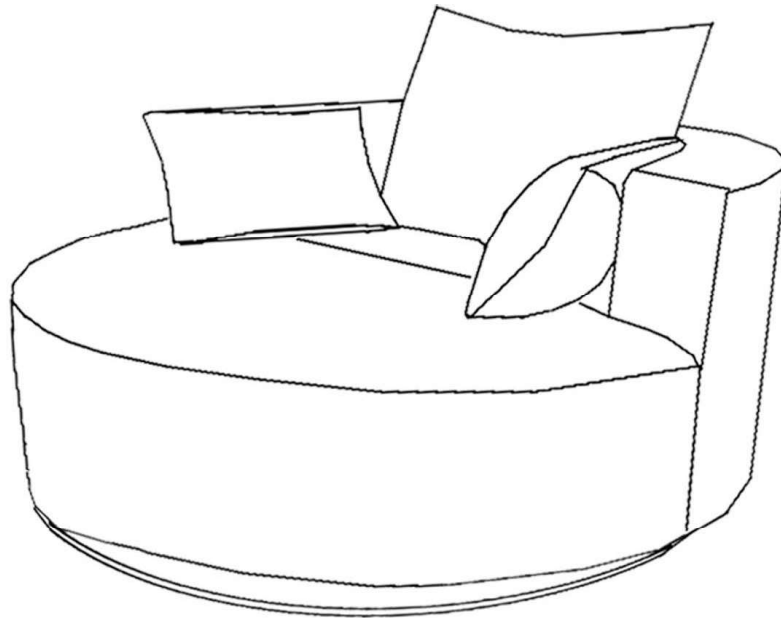

It is important to note that, given the compression sofa requires a 72-hour recovery period, if it fails to fully restore during this timeframe, please provide both photographic and video evidence showing the rebound condition at two distinct time points: 6 hours and 72 hours after unsealing the compression packaging.

Please be advised that if the submitted evidence does not clearly include observations from both time periods, we regret that we will be unable to proceed with any after-sales service.

Return & Warranty policy:

--We strive to offer the highest quality products, and we also try our best to satisfy each and every customer that orders from us with replacement parts/or service as needed.

--If the item is damaged or defective, please take photos as evidence for replacements and refunds.

--Please do not return to store, contact the seller if you have any trouble with this product.

TIPS:

1. The sectional sofa comes in 2 separate boxes, might be delivered at different times. Please wait several days patiently.
2. Due to differences of light effects, the actual color of the materials might be slightly different from the pictures.
3. No Assembly Required. This sofa can free of your stereotyped nightmare of furniture assembly.
4. Due to package compression for better shipment, the fabric may have wrinkles.
5. Please take all packages out and pat every part to make it rebound better and fluffy, so that it can restore to picture-like status.
6. Please keep children away from the plastic bags.

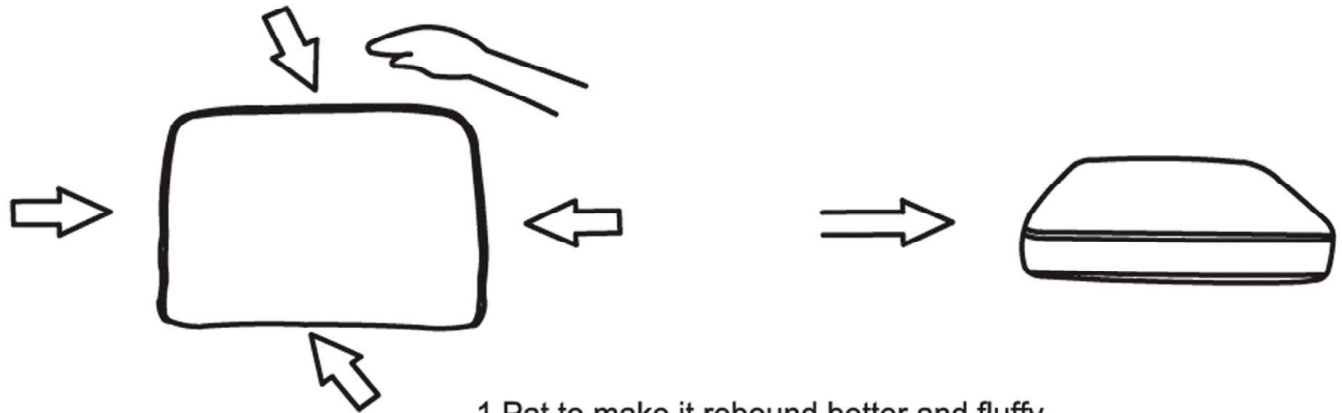

1. Pat to make it rebound better and fluffy.

2. Knead your cushion like giving your cushion a massage while allowing the air to flow through the foam.

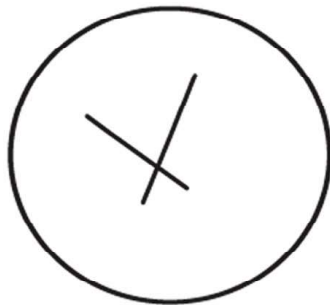

72h

It might takes up to 72 hours.



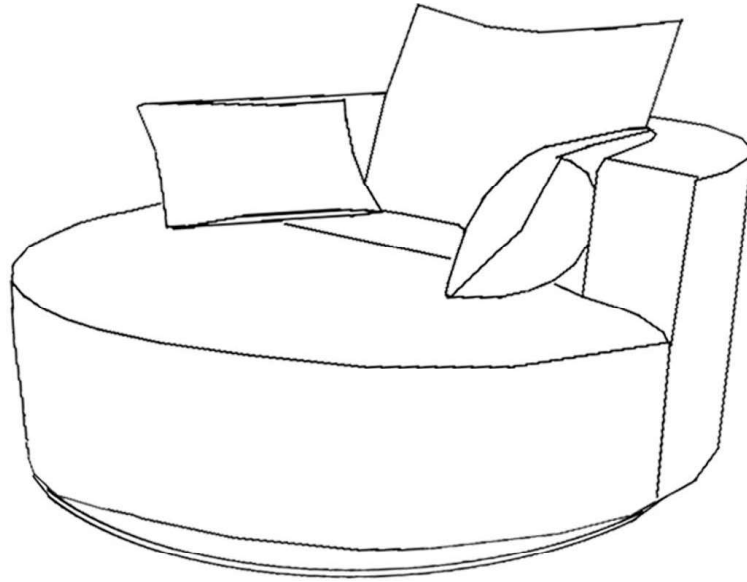

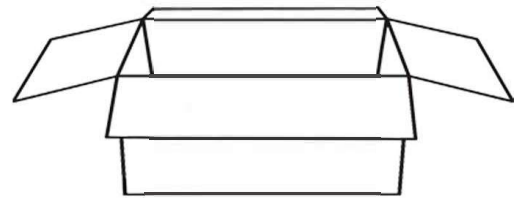
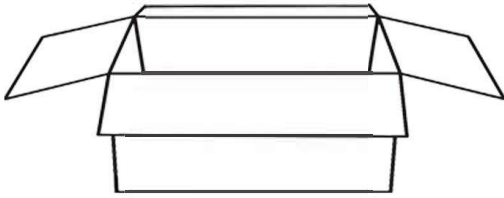

Assembly Instruction



PARTS LIST



A		Round Chair	1 PC
---	---	-------------	------

B		Wooden Base	4 PCS
C		Turntable	1 PC
D		Screw	4 PCS
F		Link Block	8 PCS
E		Screw	16 PCS
G		Iron frame extension pipe	4 PCS

Sept 1: Connect 4 pieces of wood with a link block to form a round board base.

(Please note: link block close to the edge of the board.)

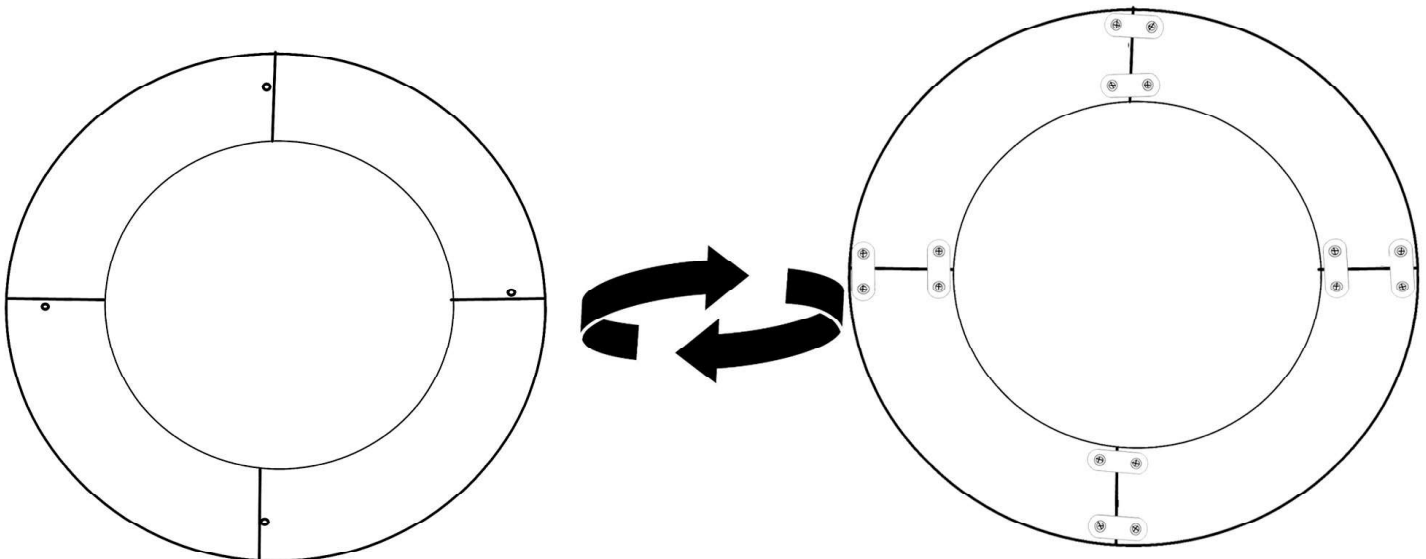
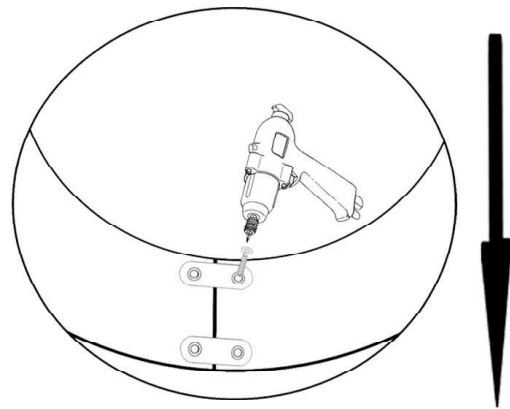
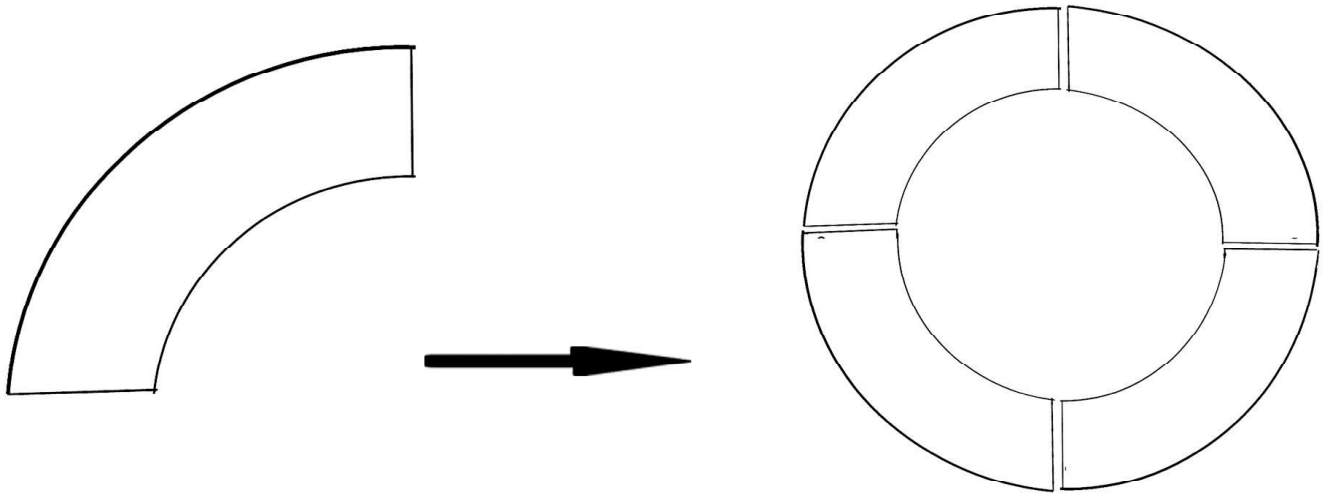

Sept 2: Unzip the lower zipper of the foam chair and securely insert the round wooden base.

After ensuring the foam is properly positioned, tighten the zipper (please ensure that the chain block panel is completely covered by the foam). Use an appropriate tool to mark the locations of the screw holes on the wooden base while it is placed under the anti-slip cloth.

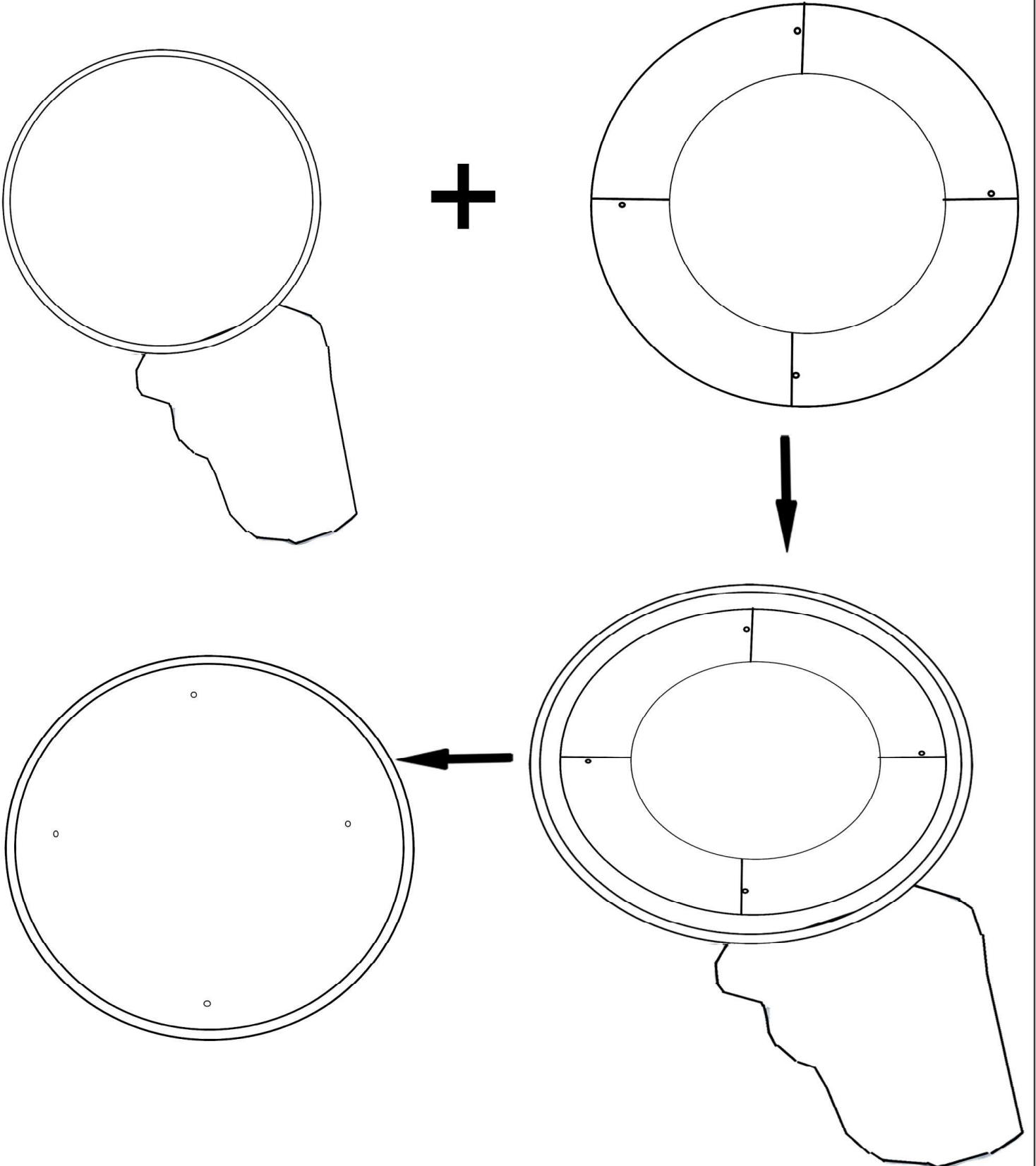

Sept 3: Attach the telescopic iron frame to the round turntable. (Adjust the enlarged circular diameter to 45.66 inches and secure the adjacent screw.)

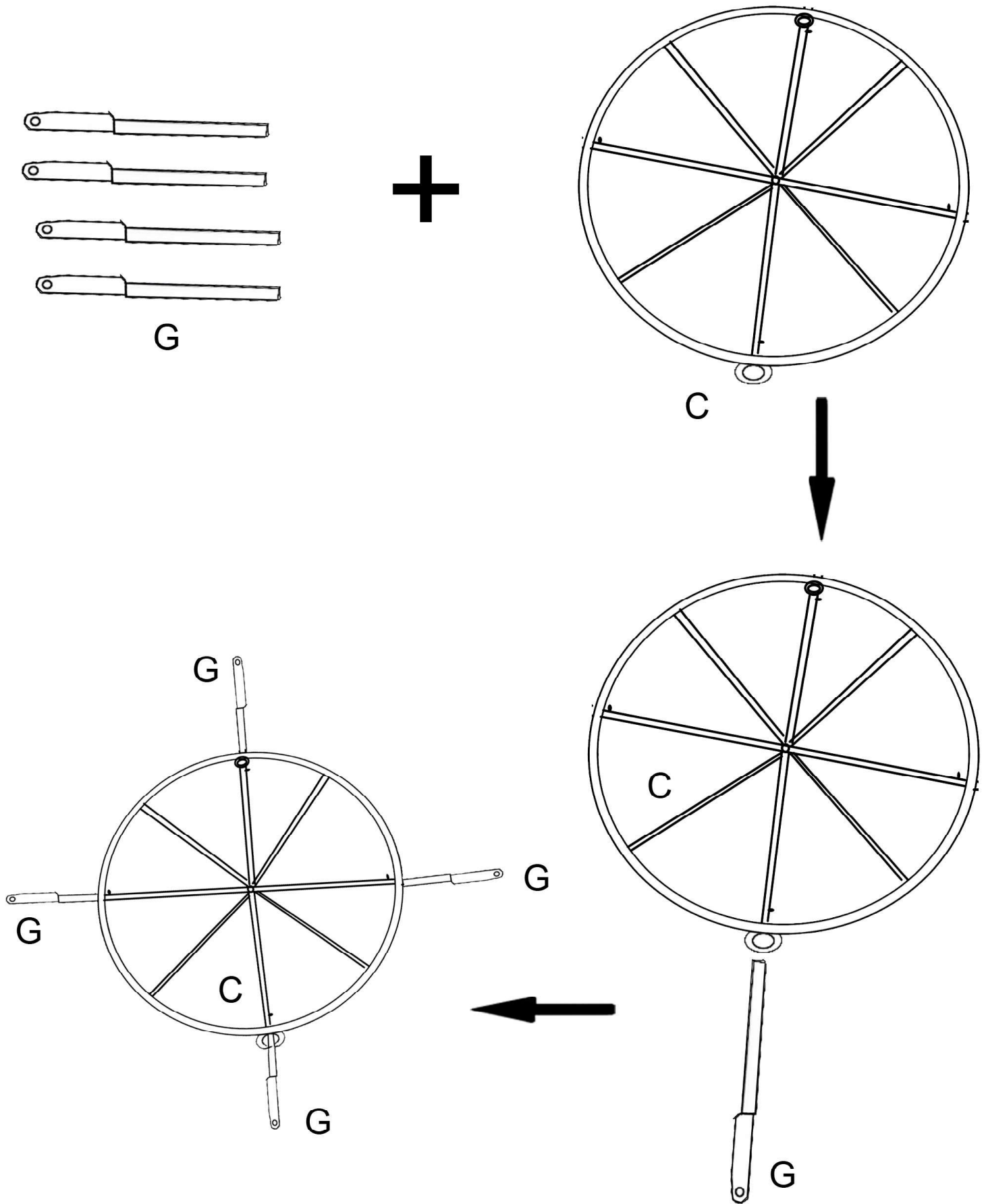

Sept 4: Install the iron frame onto the foam chair and secure the screw to the wooden base beneath the foam chair using appropriate tools. Ensure that the flat side of the iron frame is in direct contact with the floor.

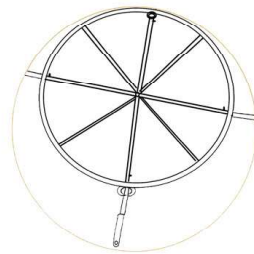
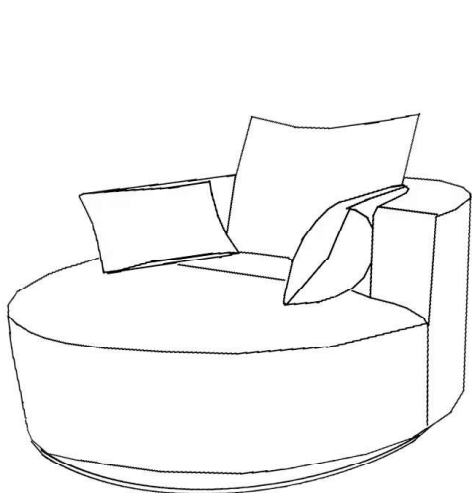
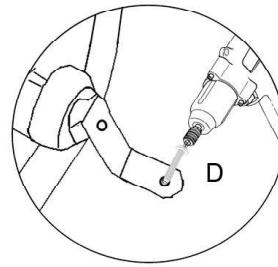
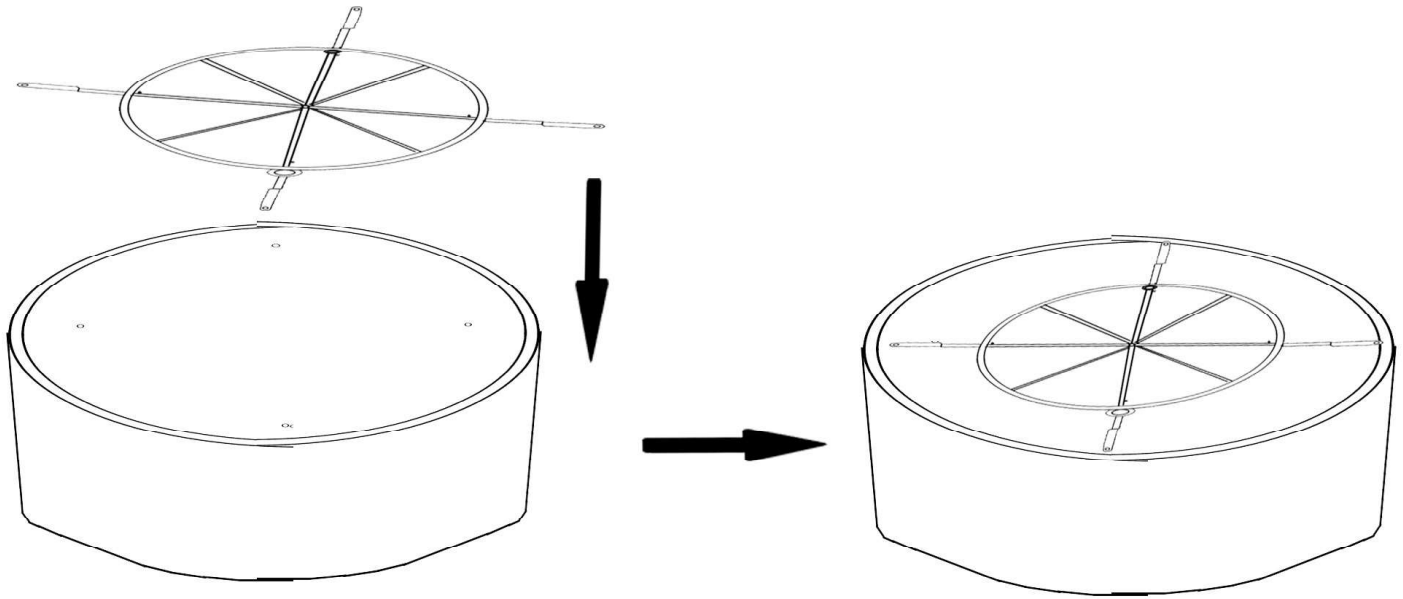

The circular wheel is in contact with the wooden base

