

## Installation Instructions

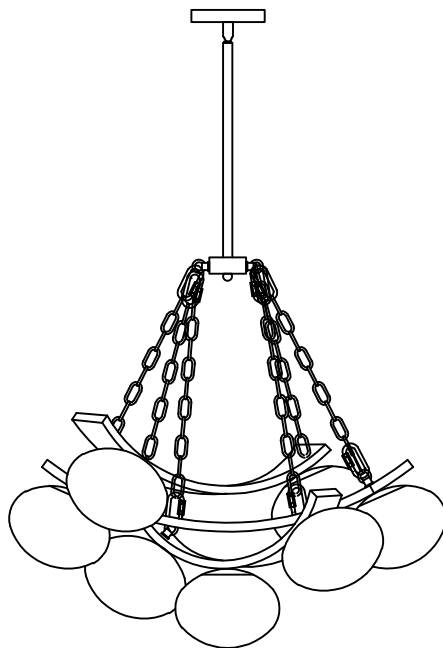

7x Max 60W Candelabra Base

## Safety Information

### READ AND SAVE THESE INSTRUCTIONS

1. For your protection and safety, carefully read and understand the information provided in this manual completely before attempting to assemble, install, or operate this product. Failure to do so could lead to electrical shock, fire, or other injuries that could be hazardous or even fatal.
2. Before touching any wire, use a voltage tester to make sure it is not live.
3. When replacing fuses, turn off the main power first. Make sure your hands and feet are dry, and place one hand behind your back to prevent electricity from making a complete circuit through your chest. Touch the plug fuse only by its insulated rim. Remove cartridge fuses with a fuse puller.
4. Use tools with insulated handles and ladders made of wood or fiberglass.
5. To protect children, place a safety cover over any unused outlets.



**DANGER:** Before starting installation of this fixture or removal of a previous fixture, disconnect the power by turning off the circuit breaker, removing the fuse at the fuse box, or tripping the breaker that controls that circuit. Tape a sign to the panel warning others to leave the circuit alone while you work.



**CAUTION:** CONSULT A QUALIFIED ELECTRICIAN IF YOU HAVE ANY ELECTRICAL QUESTIONS. If you have any non-electrical questions about this fixture please contact our customer service via the distributor where you purchased this product from. We will be more than happy to assist.

# Pre-Installation

## PLANNING INSTALLATION

Read all instructions before installing.

To avoid damaging this product, place it on a soft, non-abrasive surface, such as carpet or cardboard.

## TOOLS REQUIRED (NOT INCLUDED)

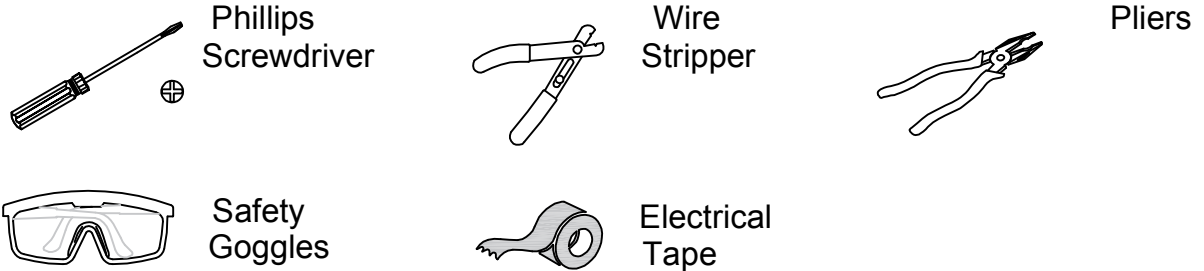

## HARDWARE INCLUDED

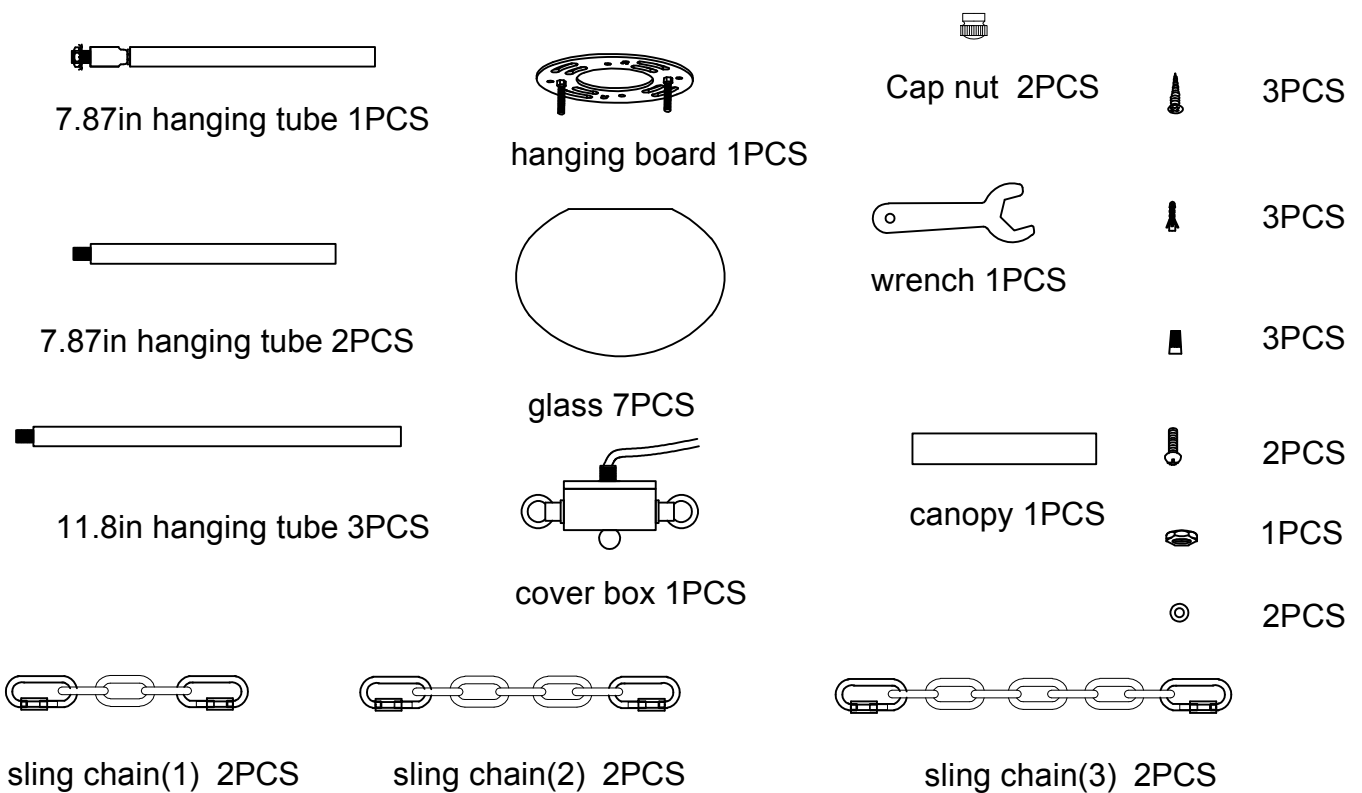

## Assembly Instructions

Assembly of this fixture will be accomplished by first determining the length of stem or chain required, attaching the mounting plate to the junction box, making all necessary electrical connections, hanging the fixture from the ceiling and then installing the fixture

## Safety Warning

Read wiring and grounding instruction and any additional directions. Turn power supply off during installation. If new wiring is required, consult a qualified electrician or local authorities for code requirements.



lamp body (1) 1PCS

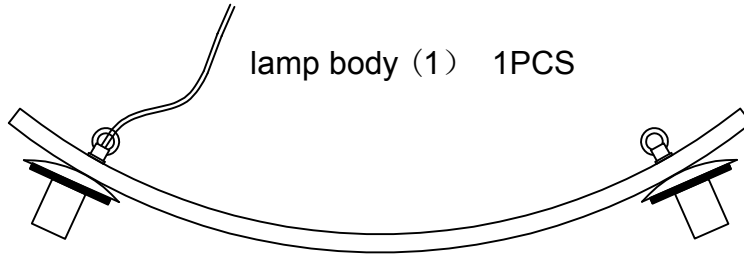

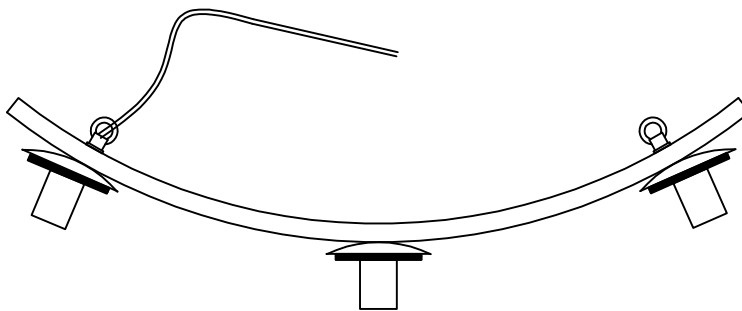

lamp body (2) 1PCS



lamp body (3) 1PCS

 3PCS

 3PCS

 3PCS

 2PCS

 1PCS

 2PCS

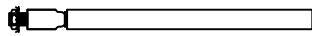

7.87in hanging tube 1PCS



hanging board 1PCS



Cap nut 2PCS

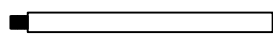

7.87in hanging tube 2PCS

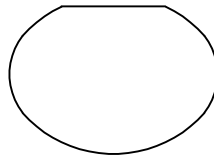

glass 7PCS

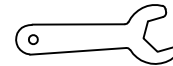

wrench 1PCS

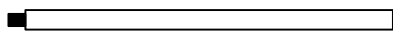

11.8in hanging tube 3PCS

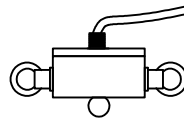

cover box 1PCS

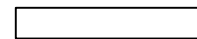

canopy 1PCS

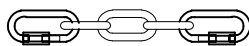

sling chain(A) 2PCS

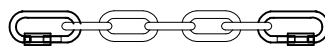

sling chain(B) 2PCS



sling chain(C) 2PCS

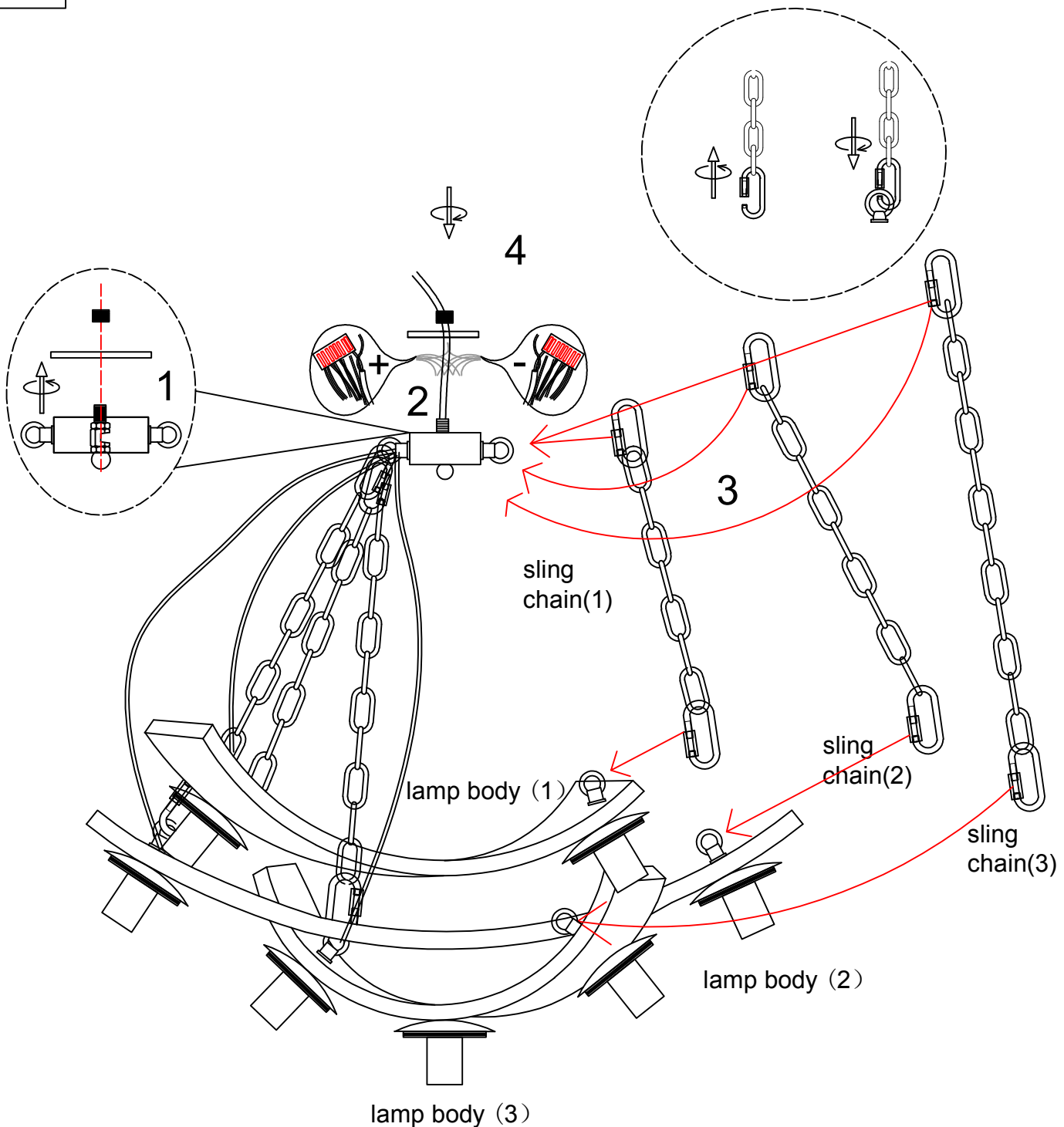

1. Loosen the upper dental tube and remove the cover
2. The wire is threaded through the hole in the closed hanging ring into the cover box, distinguishing between positive and negative, and correctly inserted into the terminal block for wiring
3. Loosen the nut on the suspension chain, tighten one end through the closed hanging ring on the cover box, and tighten the other end through the closed hanging ring on the lamp body (First install suspension chain 1 and lamp body 1, then install suspension chain 2 and lamp body 2, and finally install suspension chain 3 and lamp body 3)
4. Insert the wires and terminal blocks into the cover box, thread the main wire through the cover and nut, and tighten the nut to secure the cover

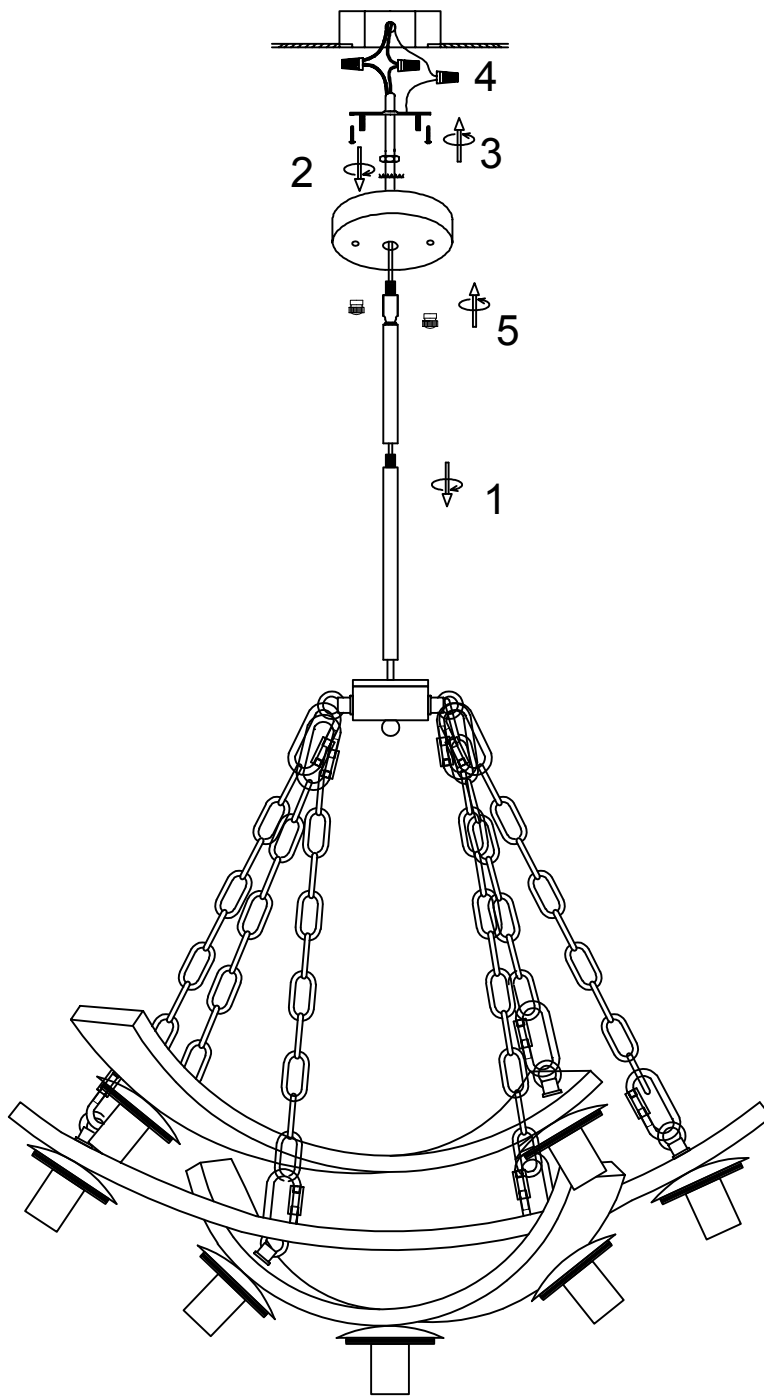

1. Thread the wires through the suspension tube and rotate the tube to tighten it
2. Thread the wires through the ceiling panel and tighten the nuts to secure the ceiling panel
3. Install the hanging board on the ceiling junction box
4. Connect the wires to the home circuit and distinguish between positive and negative
5. Install the light fixture onto the hanging board and tighten it with a nut

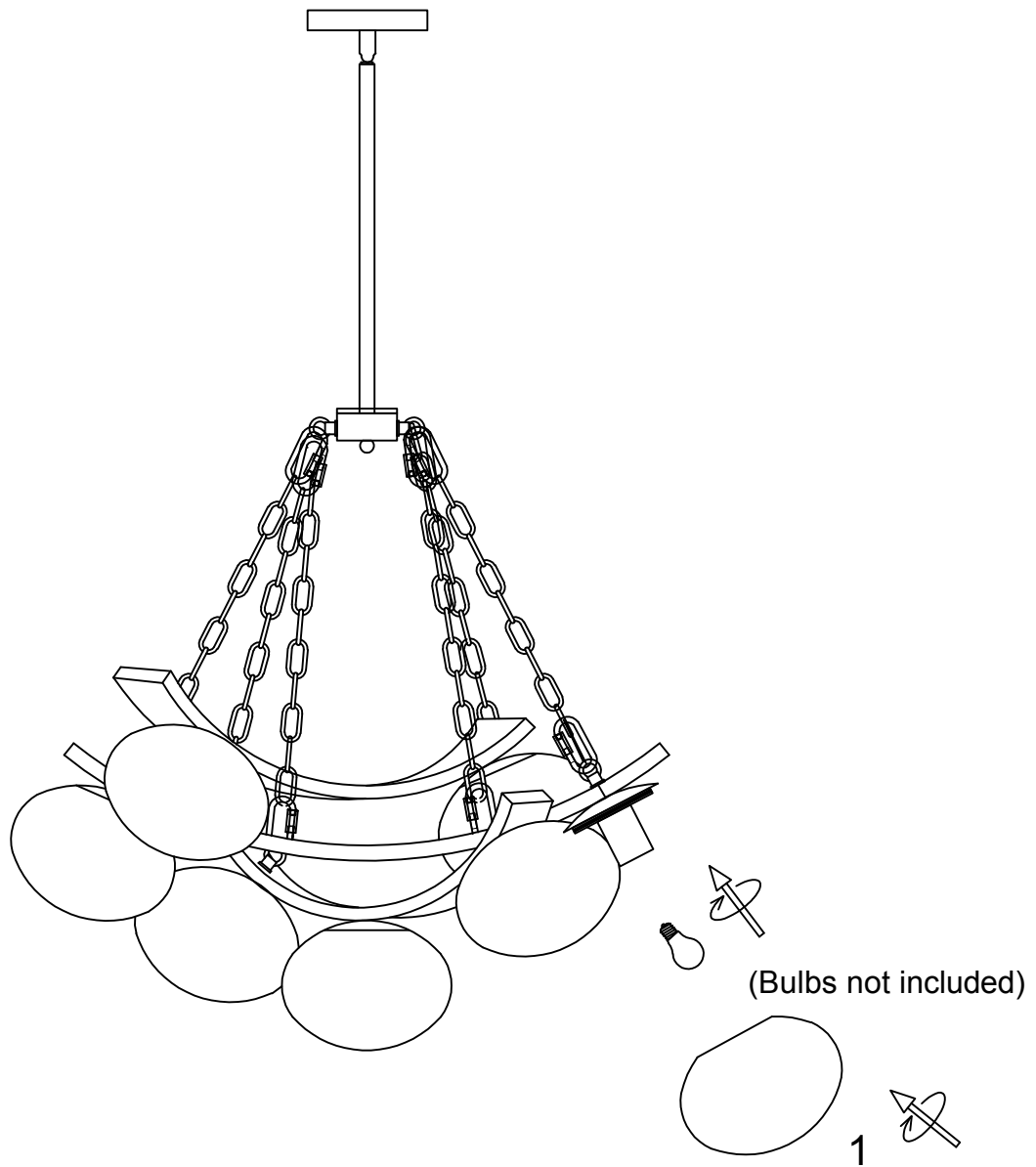

1.First, install the light bulb on the lamp head, and then screw on the glass

**Please read carefully before installation!!!**

**Note : Please make sure that the electricity is powered off during installation !**

**Only a professional electrician should install this kind of product !**

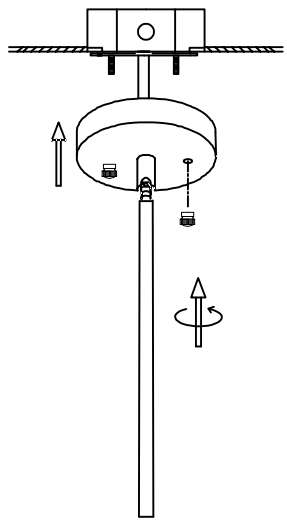
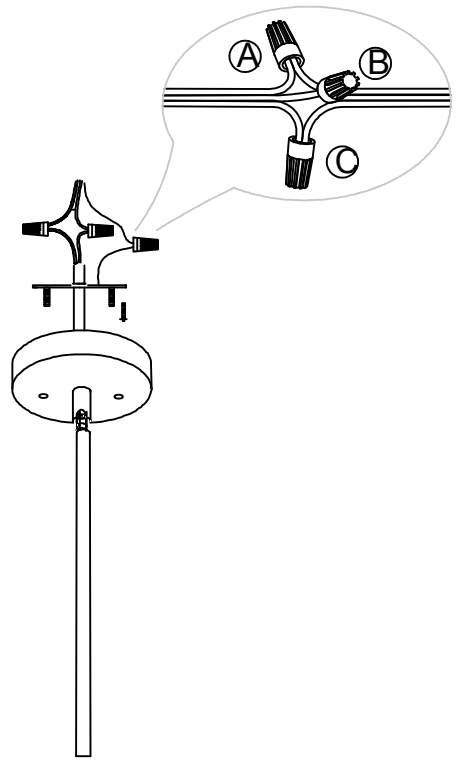
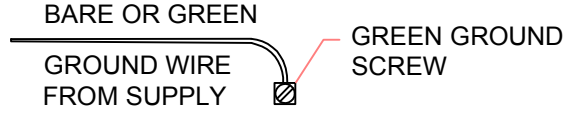
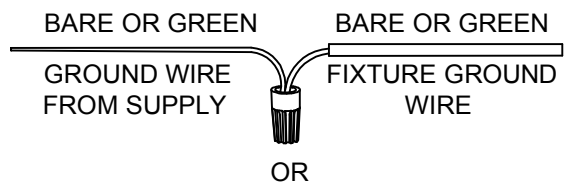
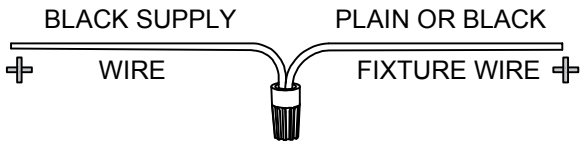
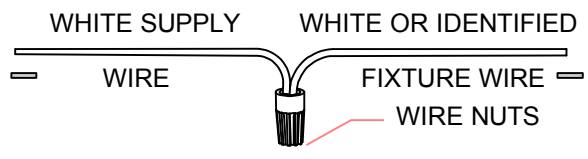
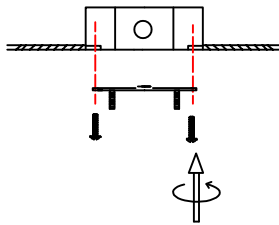

E12 SocketMax .  
60W Bulbs (not  
included)

## Disclaimer

Read this disclaimer completely and carefully before proceeding with the rest of the manual content.

### 1.Product Modifications

Any modifications or alterations to this product void any warranties and may result in damage or injury. We shall not be liable for any damages resulting from such modifications or alterations.

### 2.Compliance with Laws

Customers shall be liable for ensuring that the use of this product complies with all applicable laws and regulations in their respective jurisdictions. We shall not be responsible for any violations of laws or regulations resulting from the use of this product.

### 3.Correct Use

Always use this product only as directed in the accompanying manuals. Failure to follow instructions may result in injury or damage. Always ensure the assembly, installation, operation, maintenance, or repair of this product is carried out by a competent person. Regular maintenance should be performed throughout the lifecycle of this product. You are responsible for ensuring this product operate as intended. Always wear appropriate protective gear.

### 4.Third-Party Products

We shall not be liable for any damages or losses resulting from the use of third-party products in conjunction with our products. Customers shall refer to the third-party' sguidelines or/and warranties (if any) for any third-partyproducts used.

### 5.Limitation of Liability

We shall not be liable for any direct, indirect, punitive, incidental, special,or consequential damages to property or life, whatsoever arising out of or connected with the use or misuse of our products. In no event shall our liability exceed the value of the products sold.

### 6.Warranty

Refer to the sales page for warranty information.

This disclaimer states the entire obligation of us with respect to this product. If any part of this disclaimer is determined to be void, invalid, unenforceable, or illegal, including but not limited to the warranty disclaimers, liability disclaimers, and liability limitations set forth above, the invalid or unenforceable provision will be deemed superseded by a valid and enforceable provision that most closely matches the intent of the original provision and the remainder of the agreement shall remain in full force and effect.