

Floor Mounted Tub Filler Faucet

inch(mm)

3082400B

You may need



For easy installation of your faucet you will need:

To READ ALL the instructions completely before beginning.

To READ ALL warnings, care, and maintenance information.

Cleaning and Care

Care should be given to the cleaning of this product. Although its finish is extremely durable, it can be damaged by harsh abrasives or polish.

To clean, simply wipe gently with a damp cloth and blot dry with a soft towel.

With 1.8 gpm are compliant with California water efficiency regulations, Complies with California Proposition 65 and with the Federal Safe Drinking Water Act.

Attach hand shower to hose, with gasket between connection.

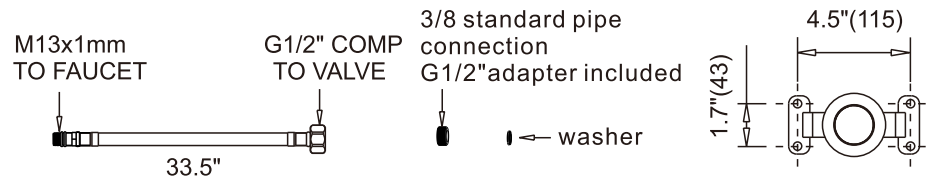
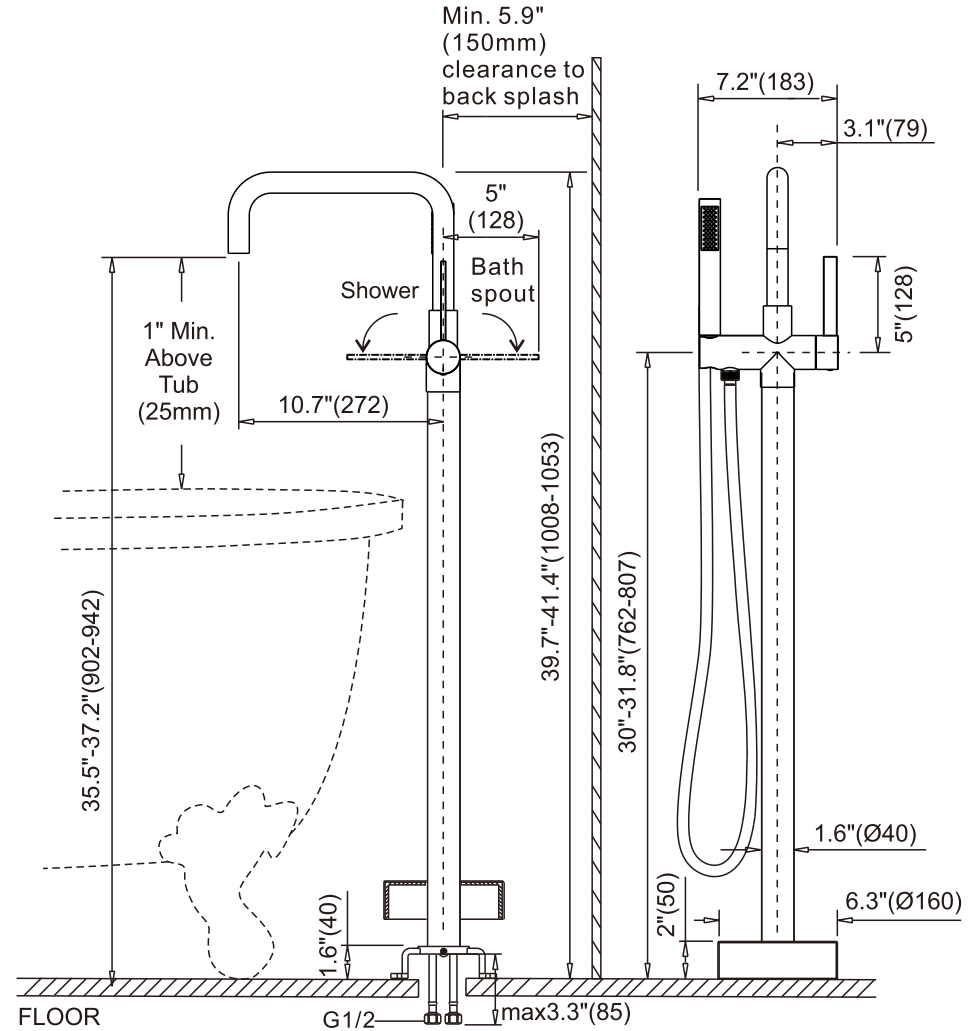
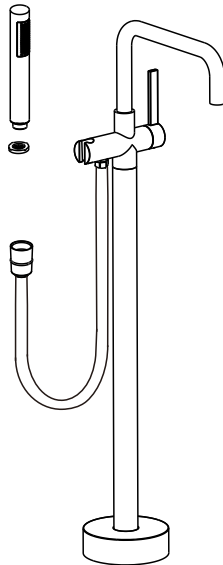

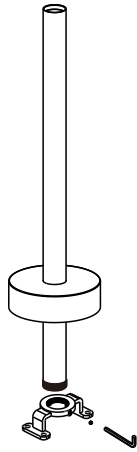

1. Place the flange over the standpipe and push it to the base.
2. Connect the brass base seat to the standpipe, fasten the base seat and standpipe with an allen key.

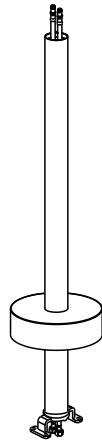

Place the water inlet supply hoses to the standpipe.

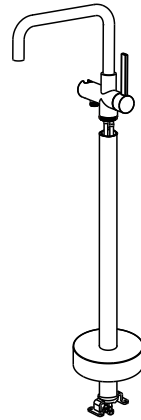

Tune the inlet supplies to mixer, verify the hot one with red line and the cold one with the blue line. Attach the mixer to the standpipe(#3). Tighten the hot and cold inlet hoses to mixer, fasten the mixer with standpipe with screws.

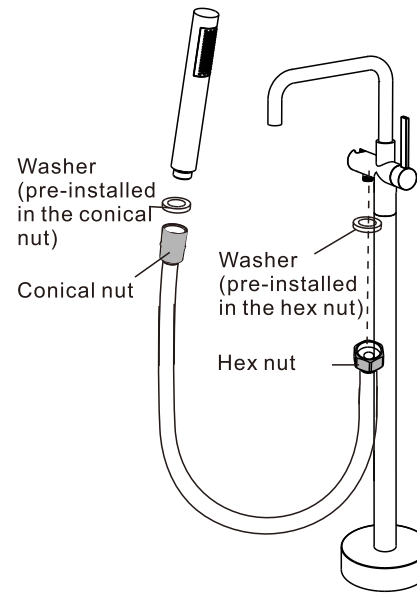

Connect one end of the shower hose to the mixer and the other end to the showerhead .

SHOWER

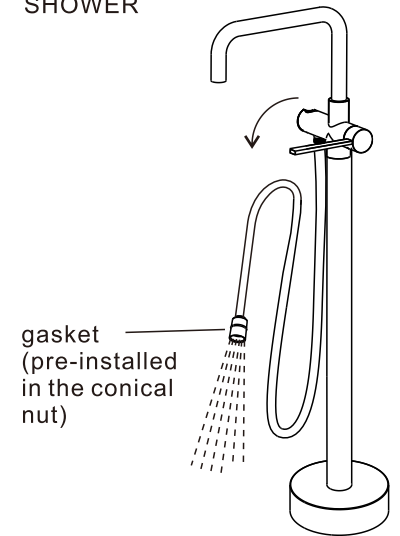

Twist here to switch ON to shower. Pull hose to its furthest extension and hold it down into the tub. Turn on hot and cold water supplies and flush water lines for one minute.

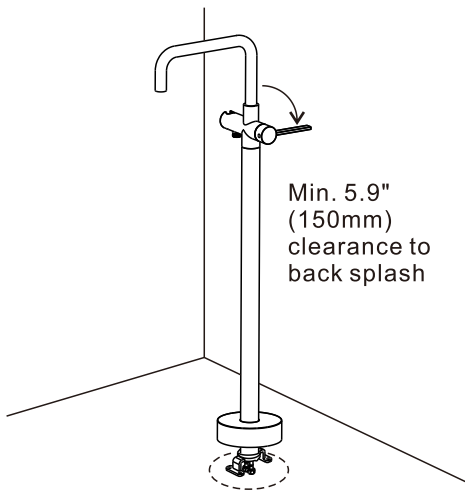

Appropriate installation distance needs to be reserved to ensure that the handle does not touch the wall when opened.

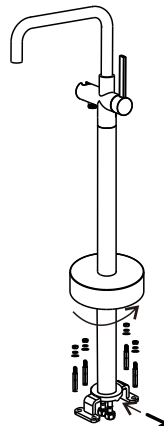

Ensure the standpipe sits flush against the finished floor surface. Then secure the standpipe using screws. Push the escutcheon over the standpipe base so that it sits flush against the finished floor surface.

Mark the locations for the screws with a pencil. With an electric drill, drill 4 holes for the expansion screws in the floor. Place the expansion screw into the holes. Connect the flexible supply lines to the water supplies.

Bath spout

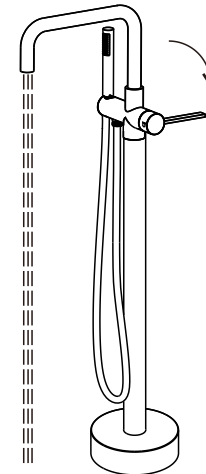

Twist here to switch ON to BATH. Turn on hot and cold water supplies and flush water lines for one minute. Important: This flushes away any debris that could cause damage to internal parts.

OFF

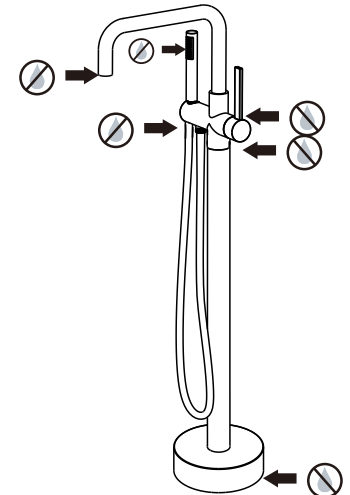

FLUSH SYSTEM/CHECK FOR LEAKS. Turn on hot and cold water supplies and flush water lines for one minute. Check all connections at arrows for leaks. Retighten if necessary, but do not overtighten.