

# ASSEMBLY INSTRUCTION

## ARMLESS CHAIR TABLE & OTTOMAN

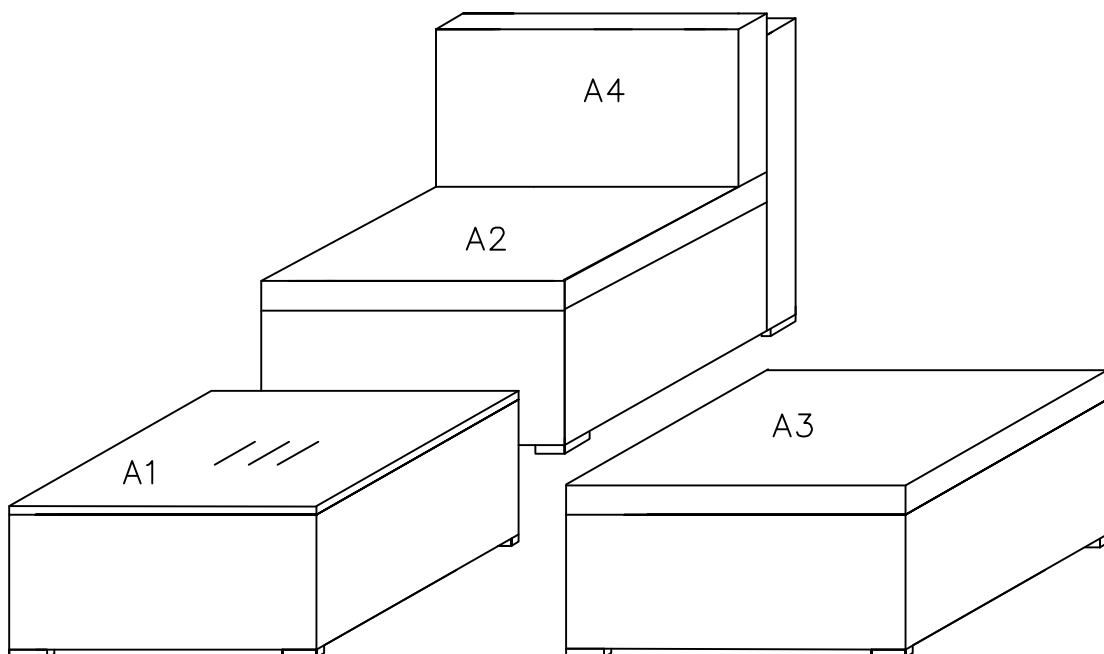

**Thank you for choosing Beefurni!**

Our goal is to provide high quality outdoor furniture with outstanding customer service at an affordable price.  
Please let us know how we are doing!

### **Problems?**

Please kindly contact us 24/7 via email [support@beefurni.com](mailto:support@beefurni.com)  
As a valued customer, your satisfaction is our #1 priority!

### **Other products?**

Please kindly find our more products at website [www.beefurni.com](http://www.beefurni.com)

## PART LIST

**B1x1**

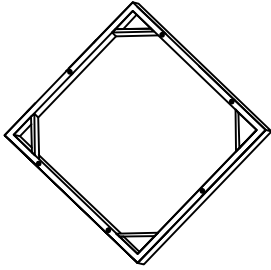

Table Top Frame

**B2x2**

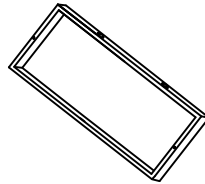
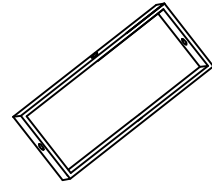

Table Leg Frame

**B3x4**



Side Frame

**C1x1**

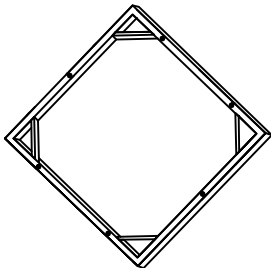

Ottoman Top Frame

**C2x2**

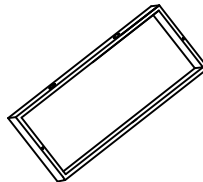

Ottoman Leg Frame

**C3x2**

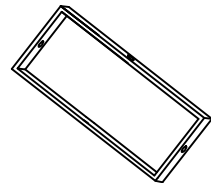

Ottoman Side Frame

**D1x1**

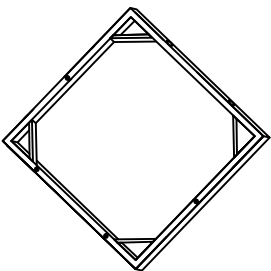

Armless Chair Seat

**D2x1**

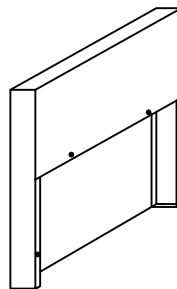

Armless Chair Back Frame

**D3x1**

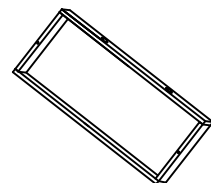

Armless Chair Leg Frame

## PART LIST

**A1x1**

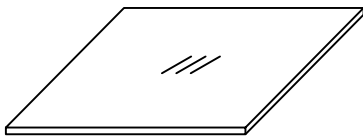

Glass Table Top

**A2x1**

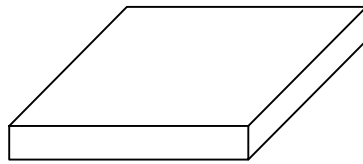

Seat Cushion

**A3x1**

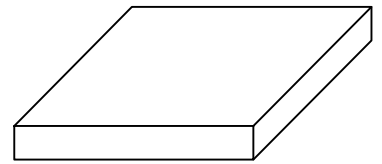

Ottoman Cushion

**A4x1**

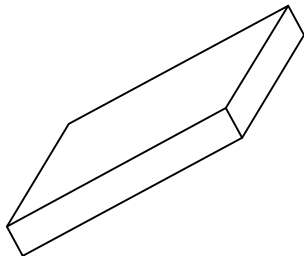

Back Cushion

**Lx2**

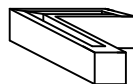

Foot L Shape

**Ix10**

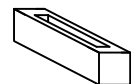

Foot I Shape

**Nx54**



Bolt M6x30

**Ox30**



Washer 15x6x1

**Px2**

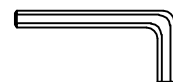

Allen Key

# COFFEE TABLE

## Step 1

Connect B1 with B2 by bolt N, washer O and allen key P

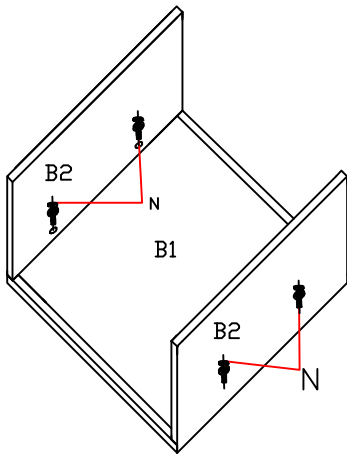

## Step 2

Connect parts from step 1 with B3 by bolt N, washer O and allen key P

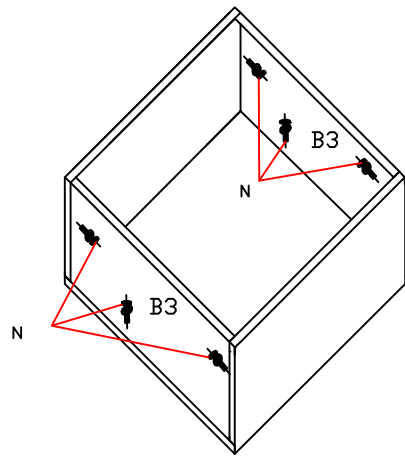

## Step 3

Connect parts from step 2 with 4 feet I shape by bolt N and allen key P

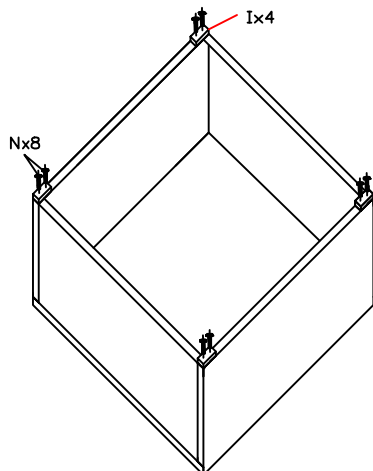

## Step 4

Put glass on the table top to complete!

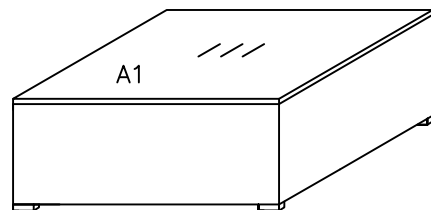

# OTTOMAN

## Step 1

Connect C1 with C2 by bolt N, washer O and allen key P

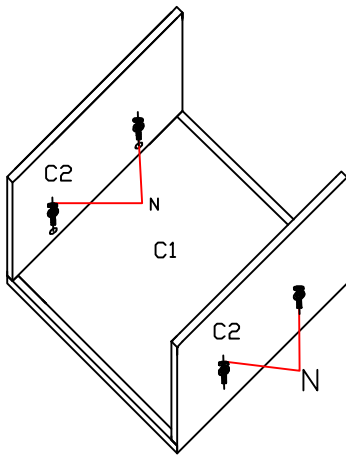

## Step 2

Connect parts from step 1 with C3 by bolt N, washer O and allen key P

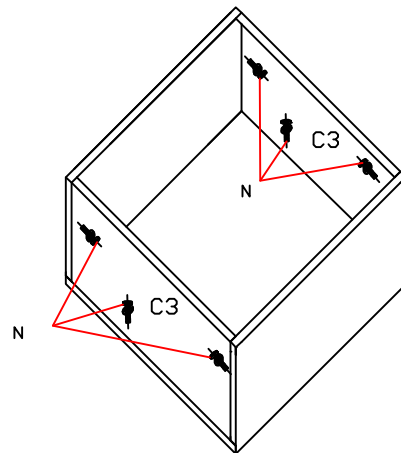

## Step 3

Connect parts from step 2 with 4 feet I shape by bolt N and allen key P

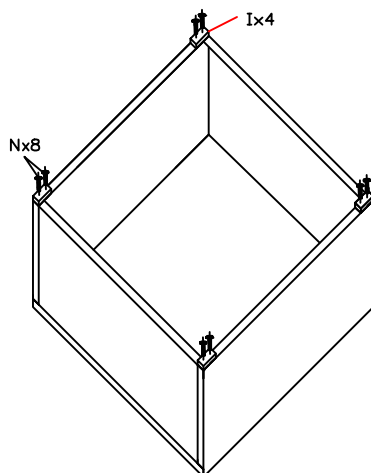

## Step 4

Put cushion A3 on the top of ottoman to complete!

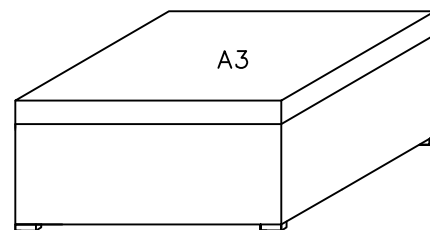

# ARMLESS CHAIR

## Step 1

Connect D1 with D2 by bolt N, washer O and allen key P

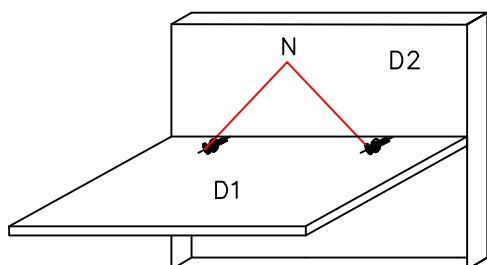

## Step 2

Connect parts from step 1 with D3 by bolt N, washer O and allen key P

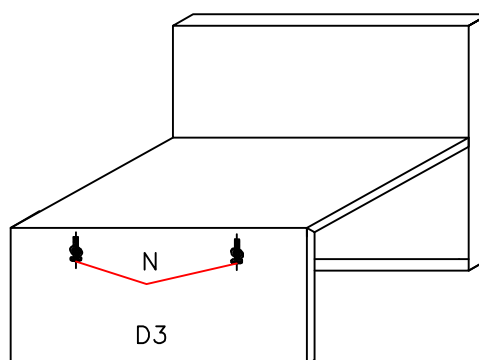

## Step 3

Connect parts from step 2 with B3 by bolt N, washer O and allen key P

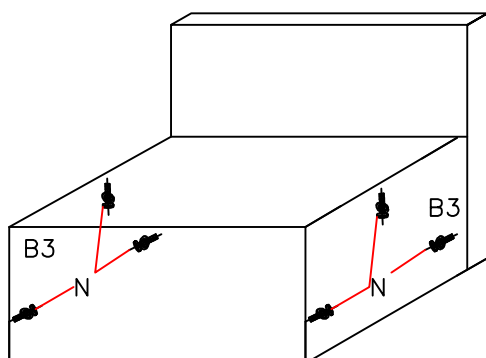

## Step 4

Connect parts from step 3 with 2 feet L shape and 2 feet I shape by bolt N and allen key P

