

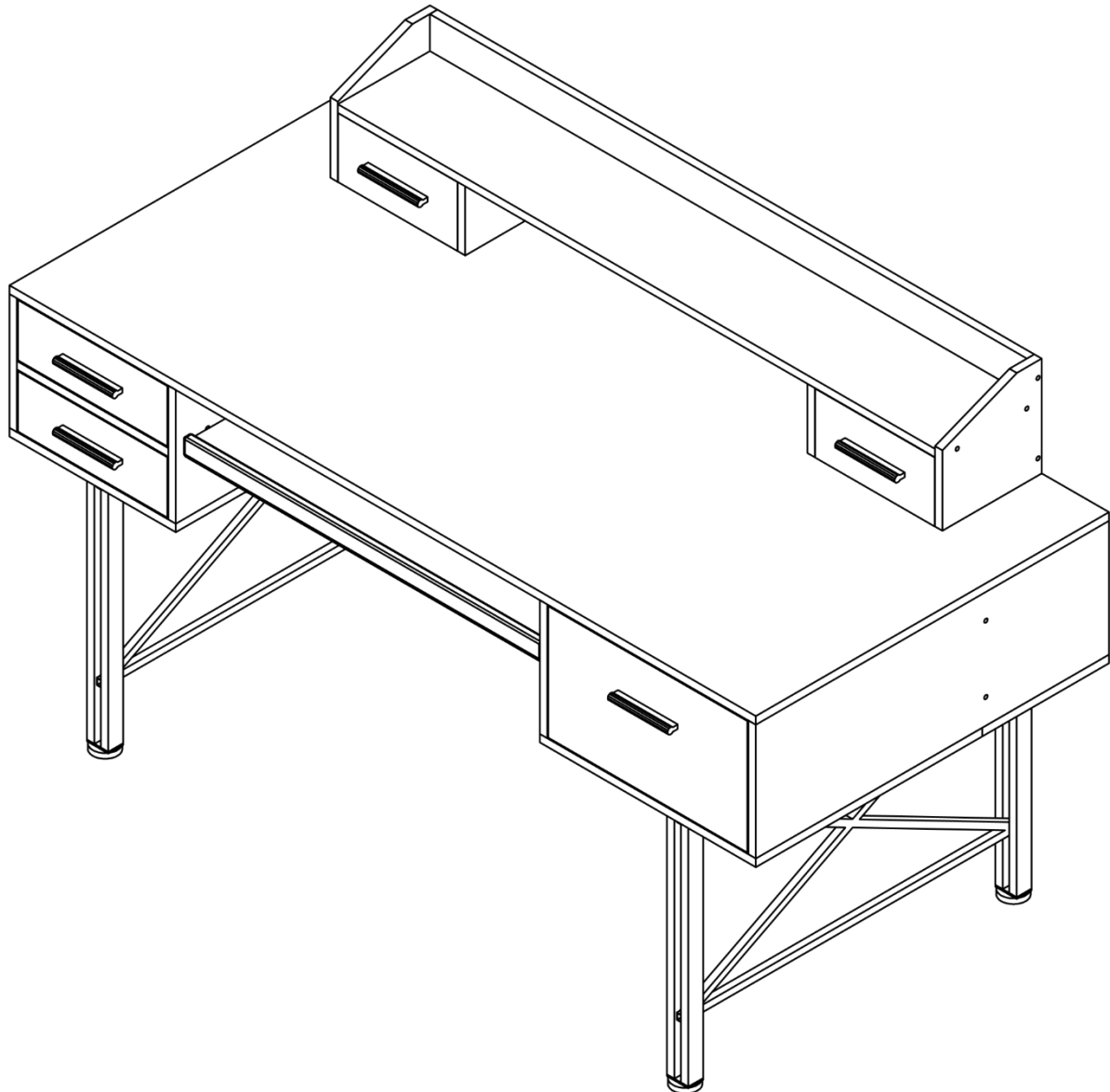









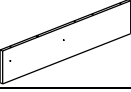
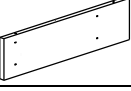
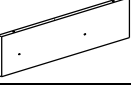
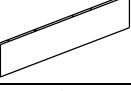
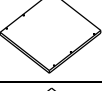
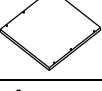

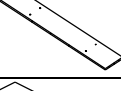
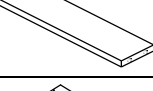

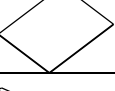



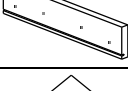





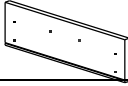

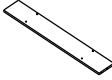

ASSEMBLY INSTRUCTION

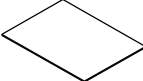
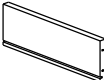
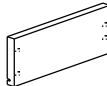
Thank you for purchasing the quality product. Be sure to check all packing material carefully for small parts which may have come loose inside the carton during shipment. Separate, identify and count all parts and metal hardware. Compare with all parts list to be sure all parts are present. If any part(s) are missing or damaged, please contact your local furniture dealer. For efficient and speedy service, please indicate the model number and code letter of part(s) needed.

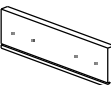
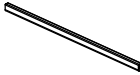
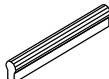
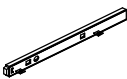

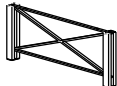
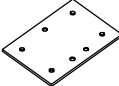







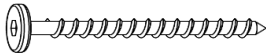

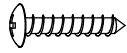

** Do not fully tighten screws until fully assembled ***

	COMPONENT PARTS	
DESCRIPTION	PART NAME	QTY(PCS)
①	DESKTOP 	1
②	RIGHT PANEL 	1
③	RIGHT PANEL 	1
④	LEFT PANEL 	1
⑤	LEFT PANEL 	1
⑥	BOTTOM PANEL-L 	1
⑦	BOTTOM PANEL -R 	1
⑧	REAR BOTTOM PANEL 	1
⑨	BACK PANEL 	1
⑩	(DRAWER)PARTITON 	1
⑪	KEYBOARD SHELF 	1
⑫	(DRAWER)BOTTOM PANEL 	2
⑬	(DRAWER)REAR PANEL 	2
⑭	(DRAWER)SIDE PANEL-L 	2
⑮	(DRAWER)SIDE PANEL-R 	2
⑯	(DRAWER)FRONT PANEL 	2
⑰	(DRAWER)BOTTOM PANEL 	1
⑱	(DRAWER)REAR PANEL 	1
⑲	(DRAWER)SIDE PANEL-L 	1

⑳	(DRAWER)SIDE PANEL-R		1
㉑	(DRAWER)FRONT PANEL		1
㉒	UPPER REAR PANEL		1
㉓	UPPER SHELF		1
㉔	UPPER SIDE PANEL-L		1
㉕	VERTICAL PANEL		2
㉖	UPPER SIDE PANEL-R		1
㉗	UPPER DRAWER BOTTOM PANEL		2
㉘	UPPER DRAWER REAR PANEL		2
㉙	UPPER DRAWER SIDE PANEL-L		2
㉚	UPPER DRAWER SIDE PANEL-R		2
㉛	UPPER DRAWER FRONT PANEL		2
㉜	PLASTIC STRIP		1
㉝	HANDLE		5
㉞	SLIDER		1
㉟	SLIDER		1
㊱	SIDE FRAME		2
㊲	METAL PLATE		4
㊳	L-SHAPE SUPPORT		7
㊴	STRIP COVER-R		1
㊵	STRIP COVER-L		1

HARDWARE REQUIRED

(A)		ALLEN SCREW	M5X50MM	37	PCS
(B)		PHILLIPS SCREW	M4X32MM	20	PCS
(C)		PHILLIPS SCREW	M6X14MM	12	PCS
(D)		ALLEN BOLT	M6X12MM	4	PCS
(E)		ALLEN BOLT	M6X25MM	8	PCS
(F)		PHILLIPS SCREW	M4X21MM	10	PCS
(G)		PHILLIPS SCREW	M4X12MM	22	PCS
(H)		ALLEN SCREW	M4X15MM	16	PCS
(I)		PHILLIPS SCREW	M4X12MM	6	PCS
(J)		WOODEN PEG		32	PCS
(K)		WASHER		6	PCS
(L)		STUD		4	PCS
(M)		ALLEN WRENCH		1	PCS

Attention

***Some number parts listed on the instruction sheet may not be in parts bag as they may already be assembled. Carefully check parts and packing materials prior to ordering replacements.

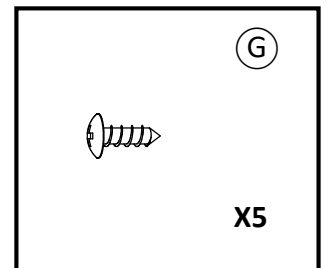
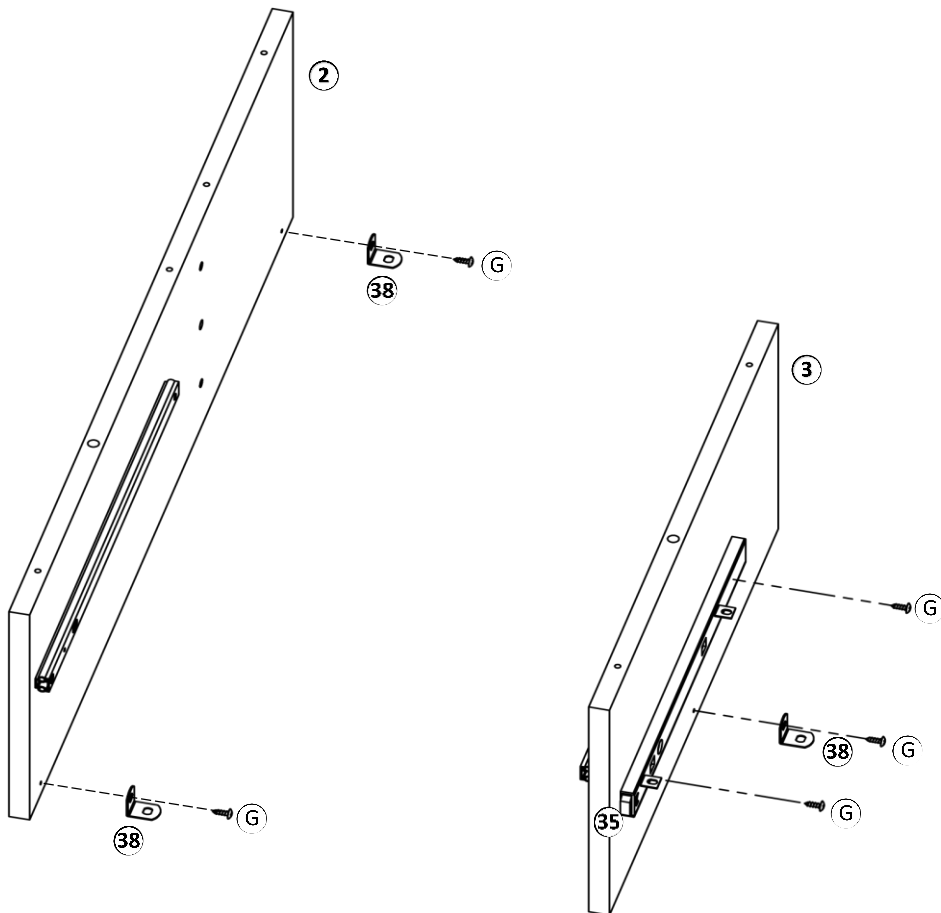
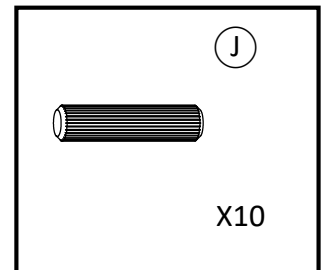
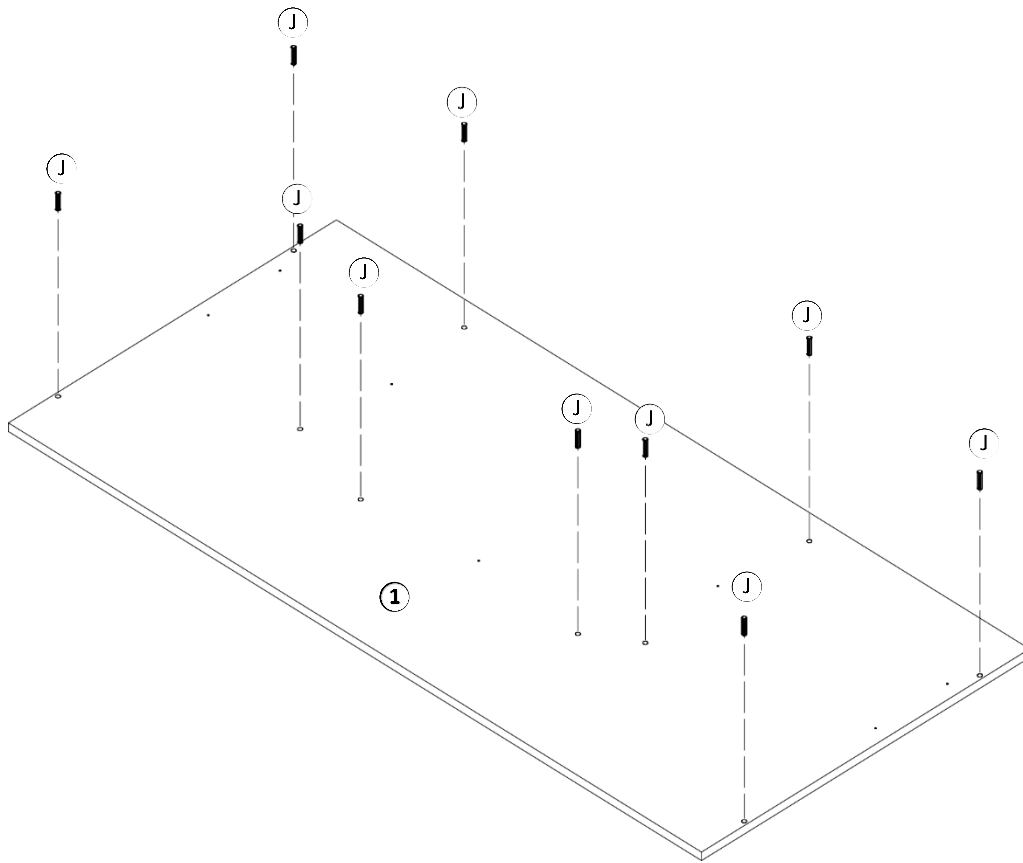

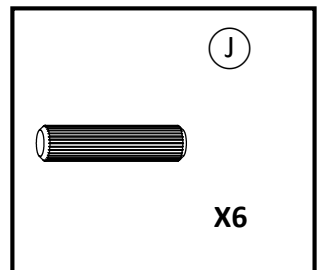
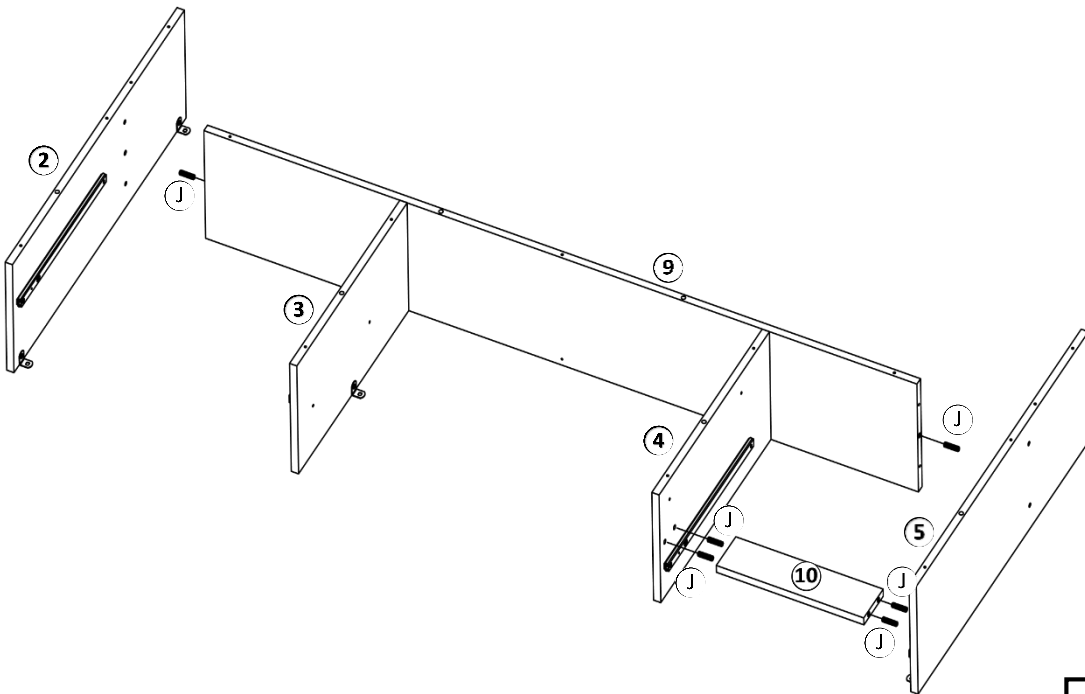
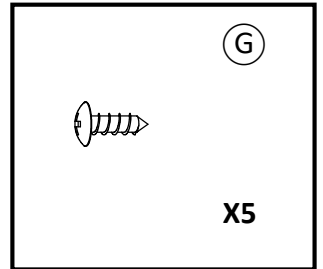
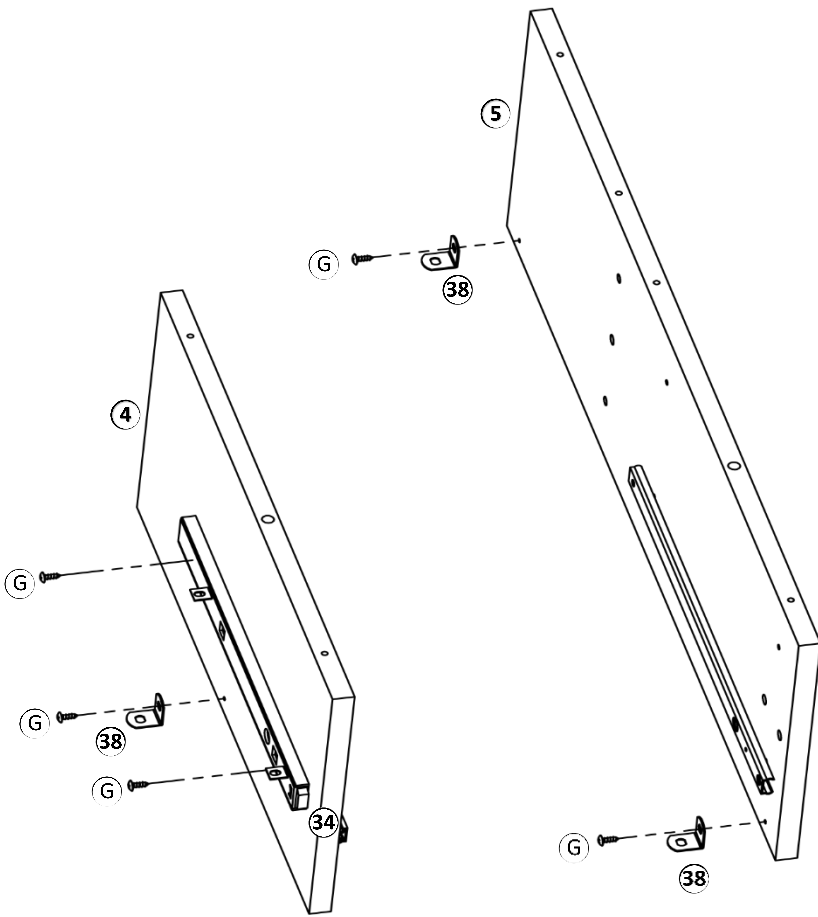

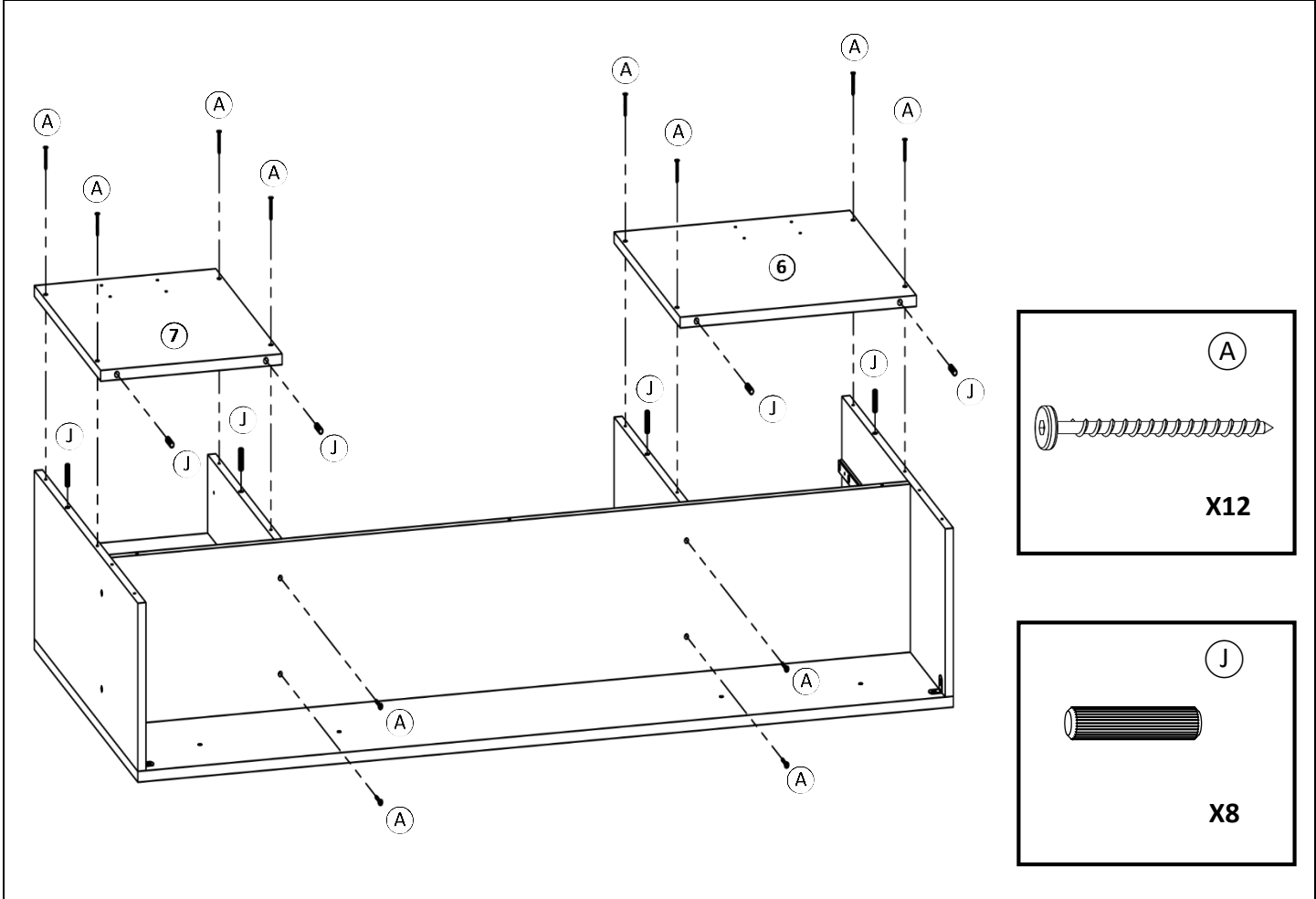
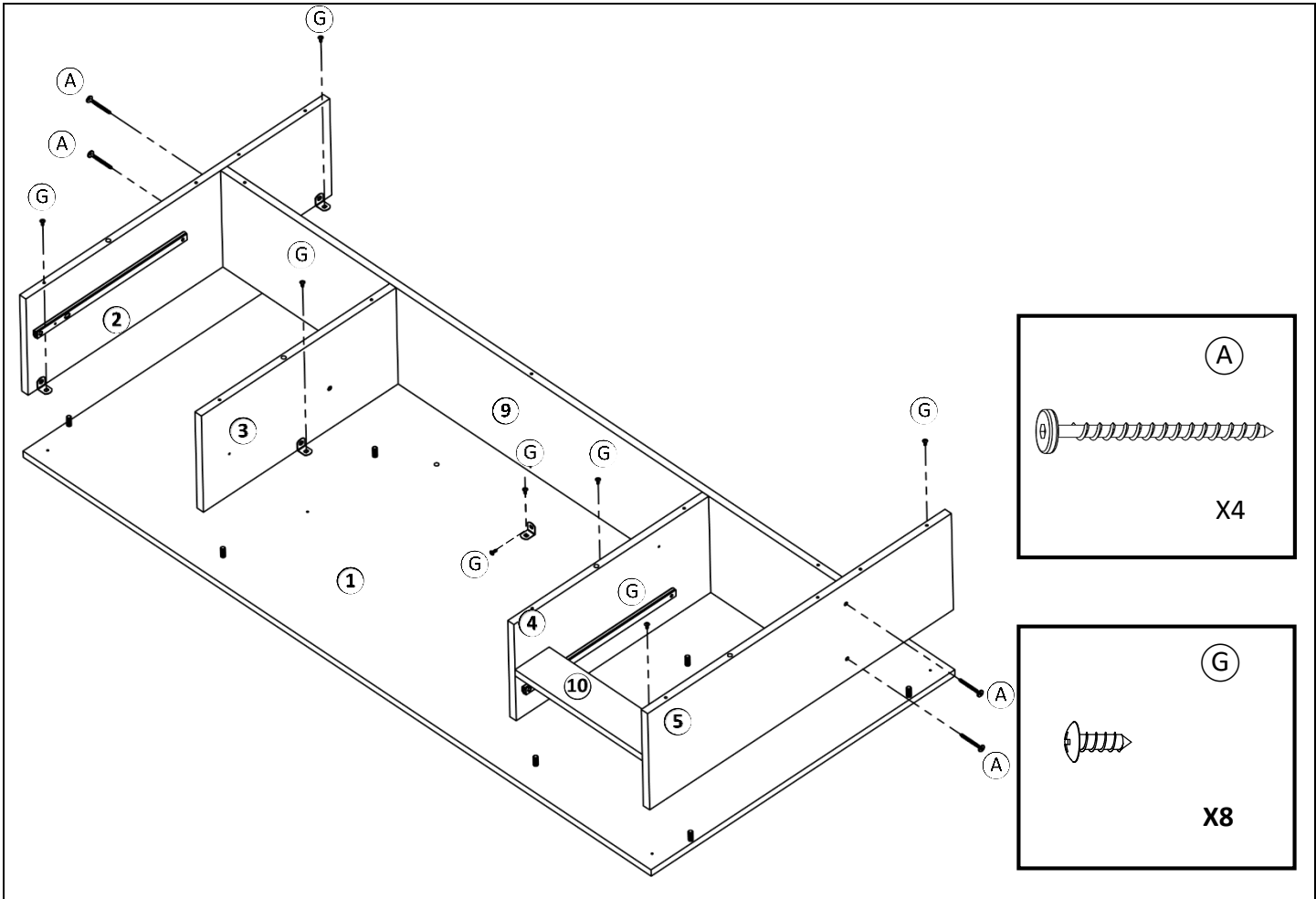

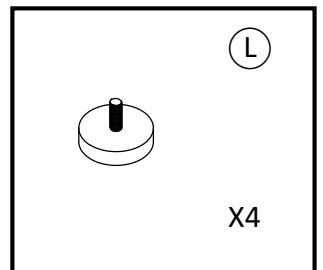
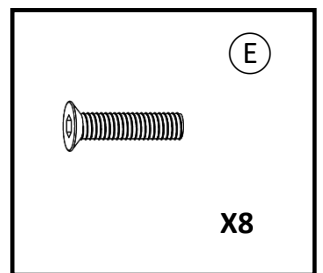
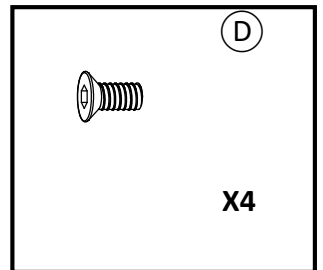
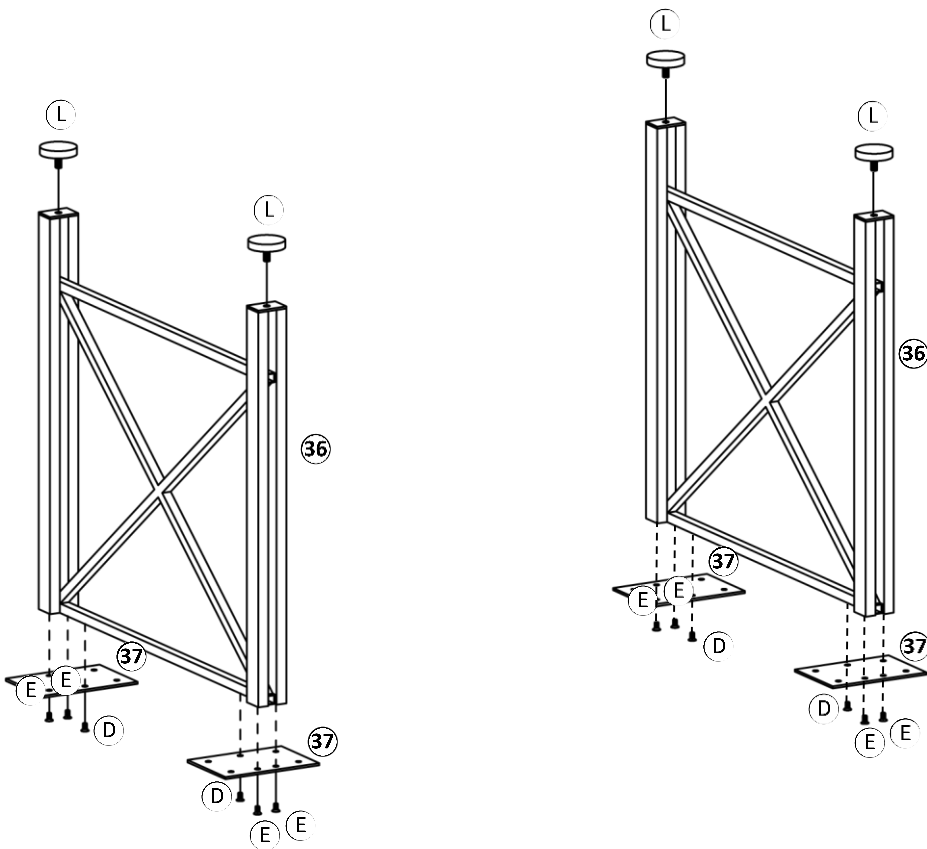
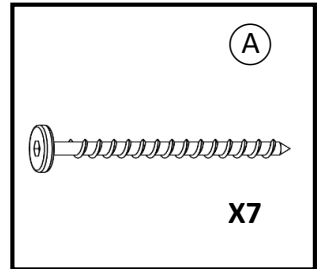
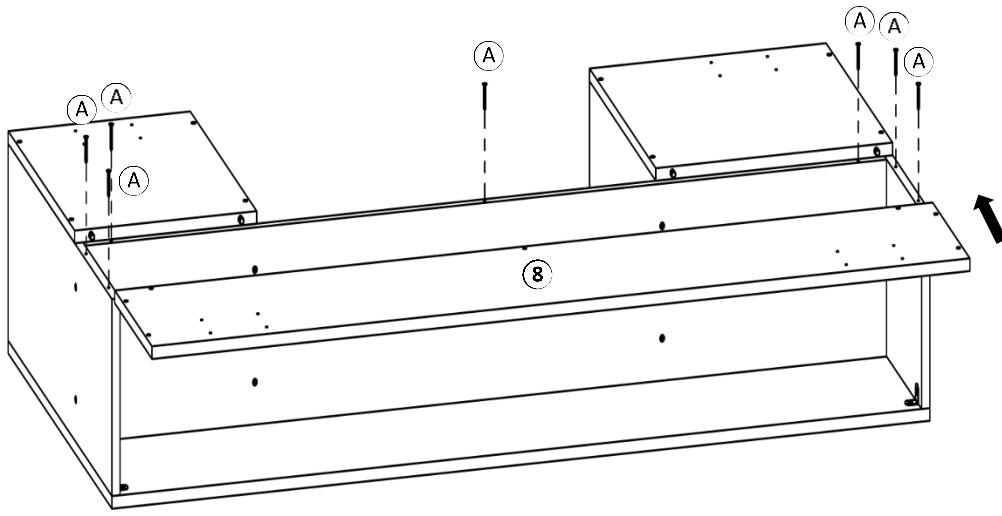

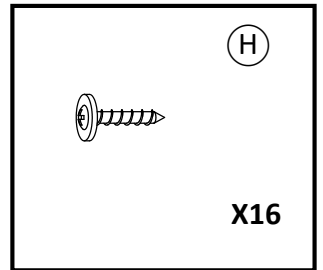
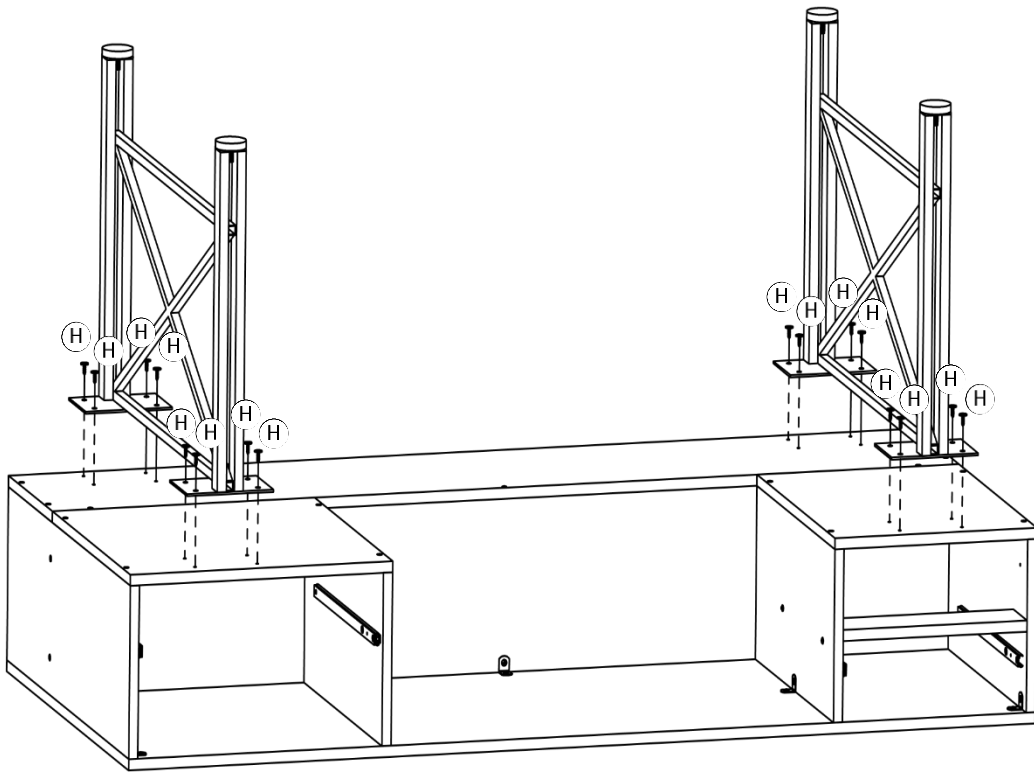

X2

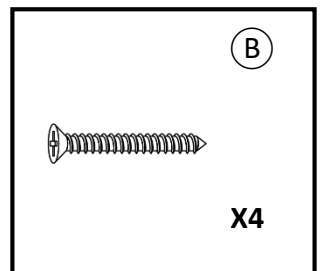
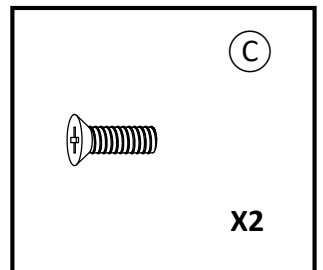
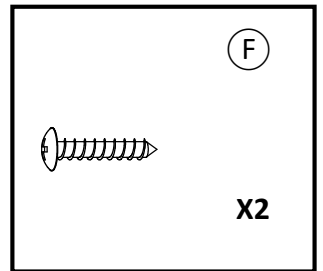
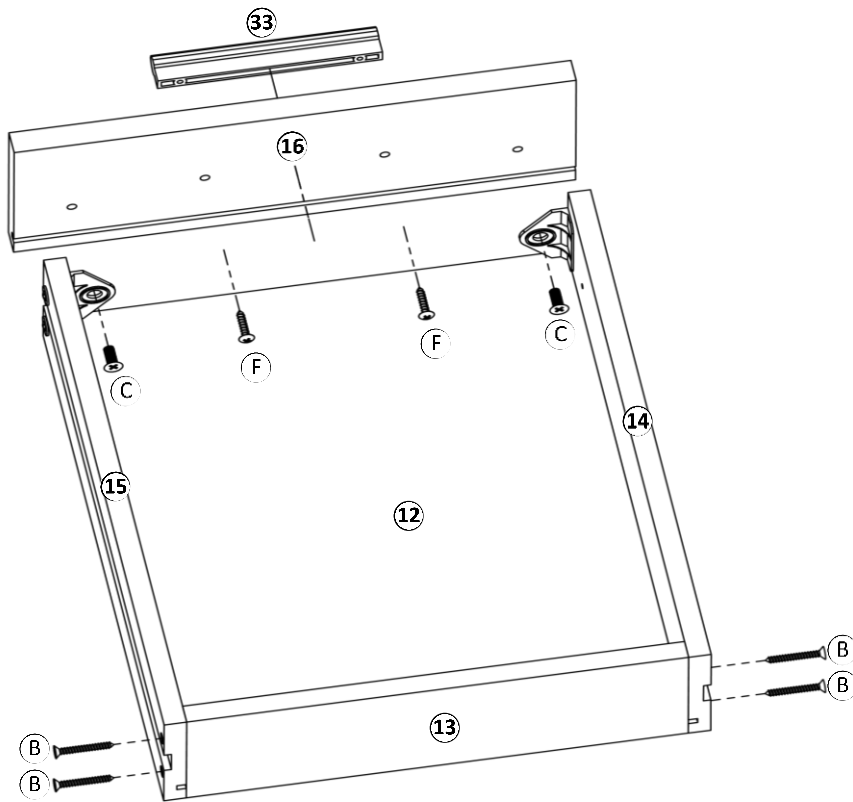

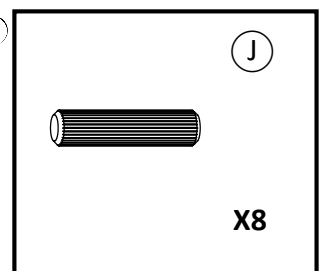
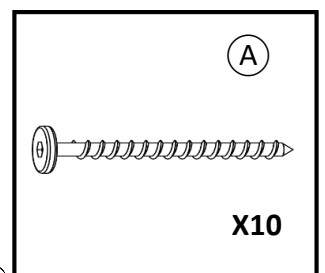
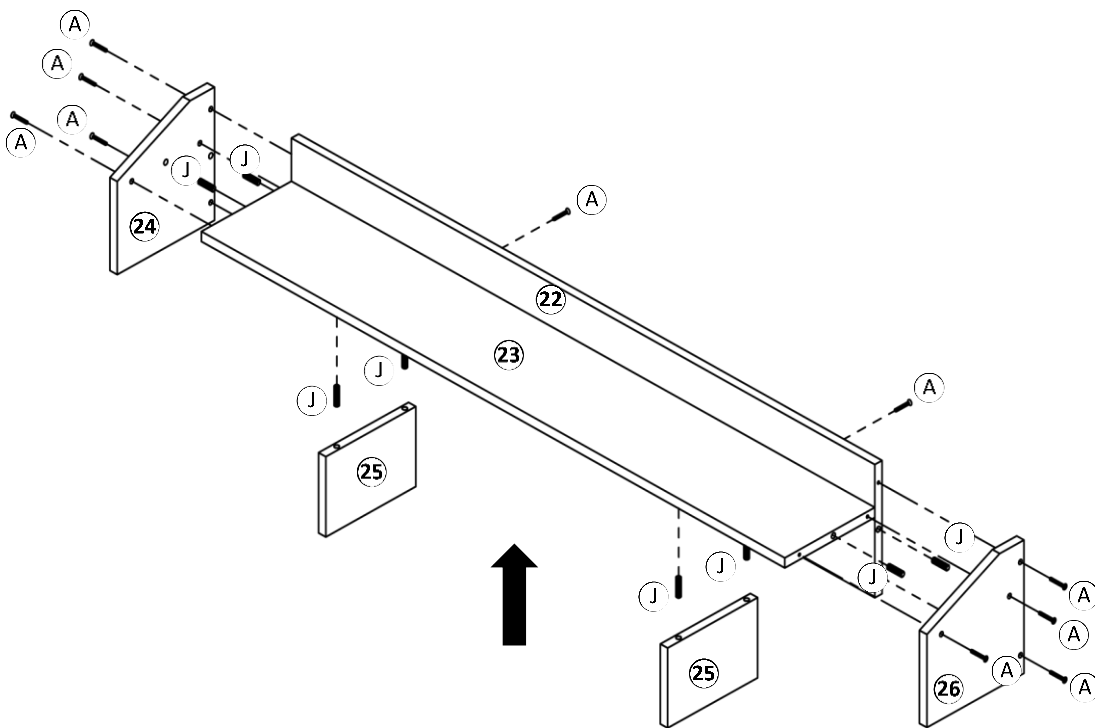
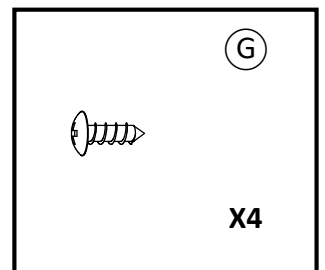
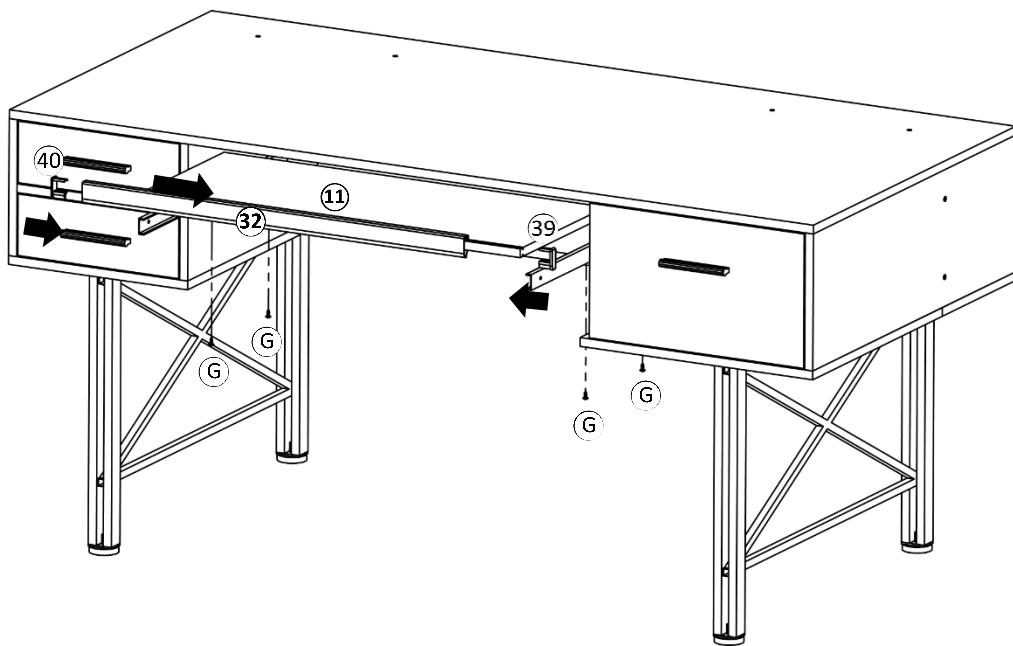

X2

