

Outdoor Shower Installation Instructions

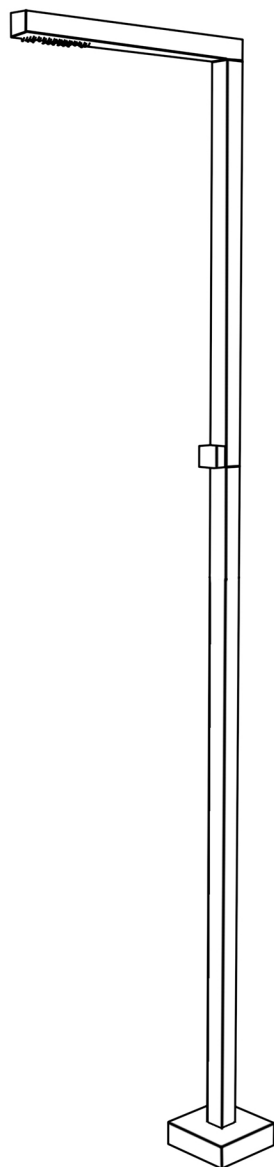

Product Inspection:

This product has been inspected and adjusted to its optimal condition.
Please unpack and prepare all parts for installation.

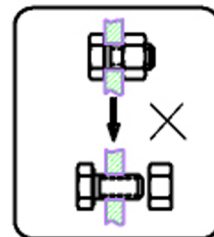

Before Installation:

Ensure that the water pipes are free of debris and dirt to prevent clogging the shower head, which could affect water flow.

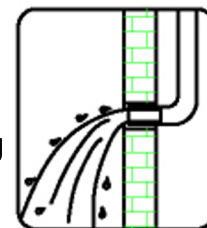

Please Do Not Return the Product to the Store.
Contact us with any questions.

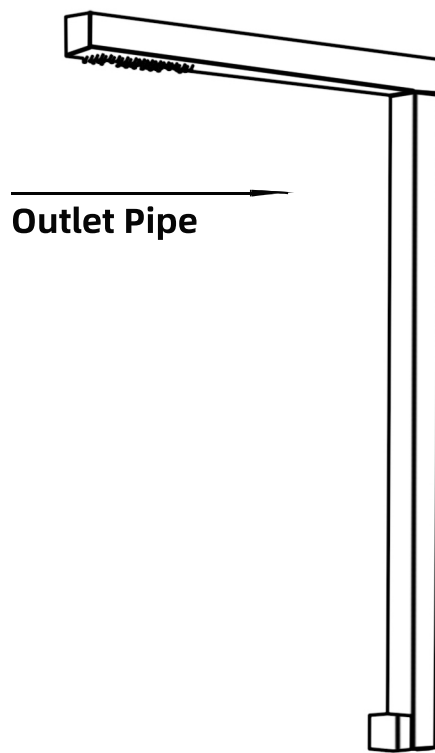

Outlet Pipe

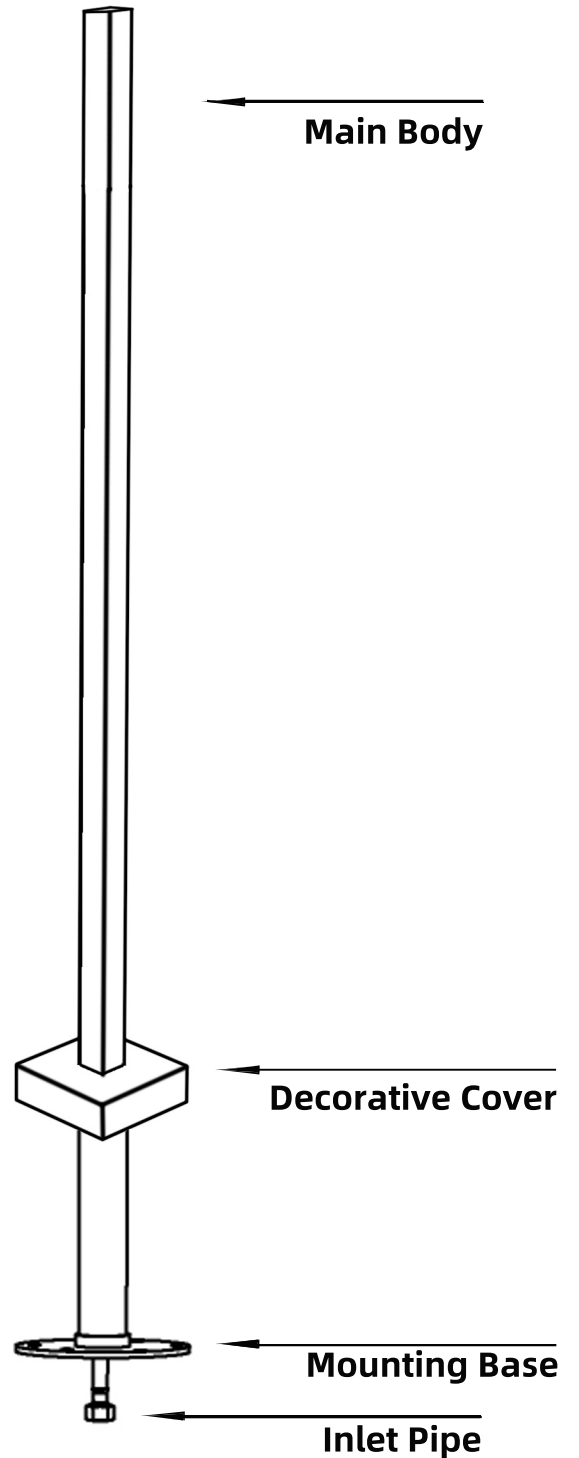

Main Body

Decorative Cover

Mounting Base

Inlet Pipe

Expansion Screws



Check Parts

Standard Accessories List:

When you open the package, check if the main body and accessories match your purchase. If not, contact the seller.

Note:

1. Accessories may change without prior notice under non-impact conditions.
2. Product appearance is subject to the actual item; diagrams are for reference only.

Installation Steps:

This product requires installation on the ground surface.

1. Determine Installation Location & Prepare Plumbing

- For cold-water models, run a cold supply line to the location.
- For hot & cold models, run separate "H" and "C" supply lines.
- If necessary, cut or trench a channel to route the pipes and align them with the inlets.
- Turn off the main water before connecting and follow local plumbing codes.

2. Follow the diagram to mark the location.

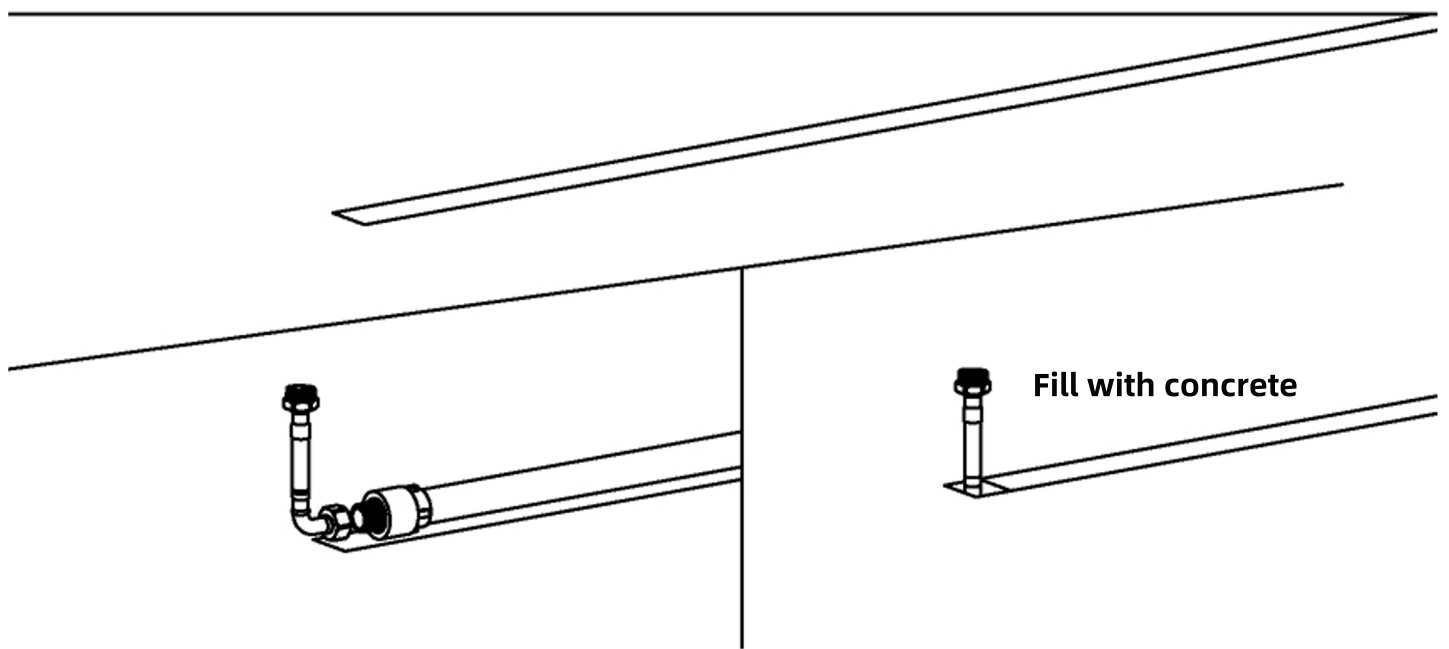

3. Install the expansion screws.

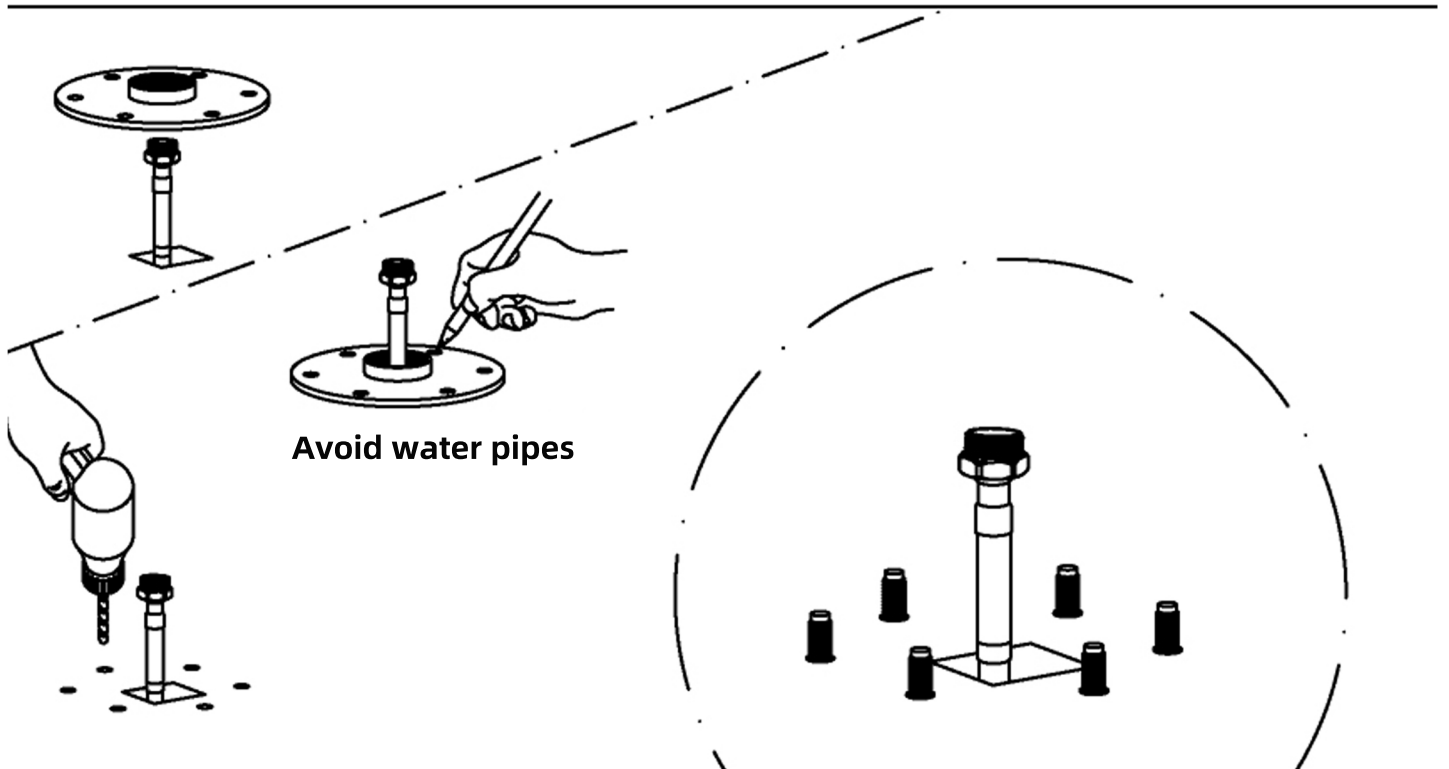

4. Install the Outlet Pipe.

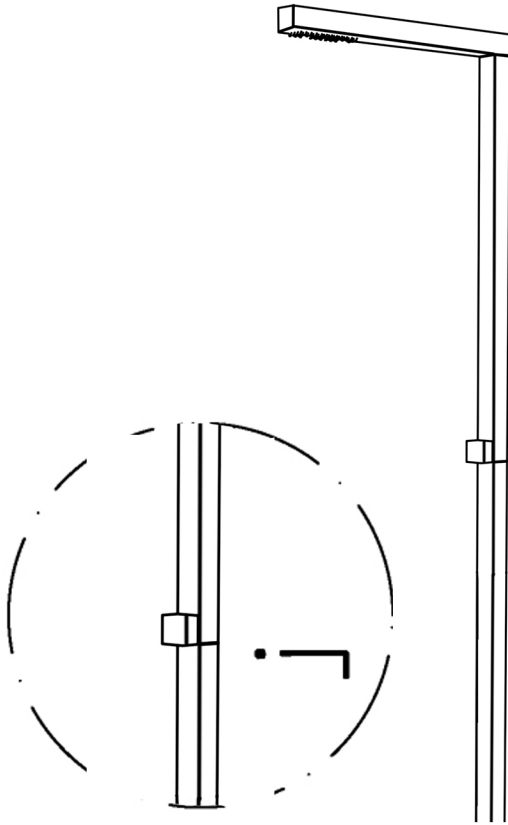

5. Install the Shower Head Body.

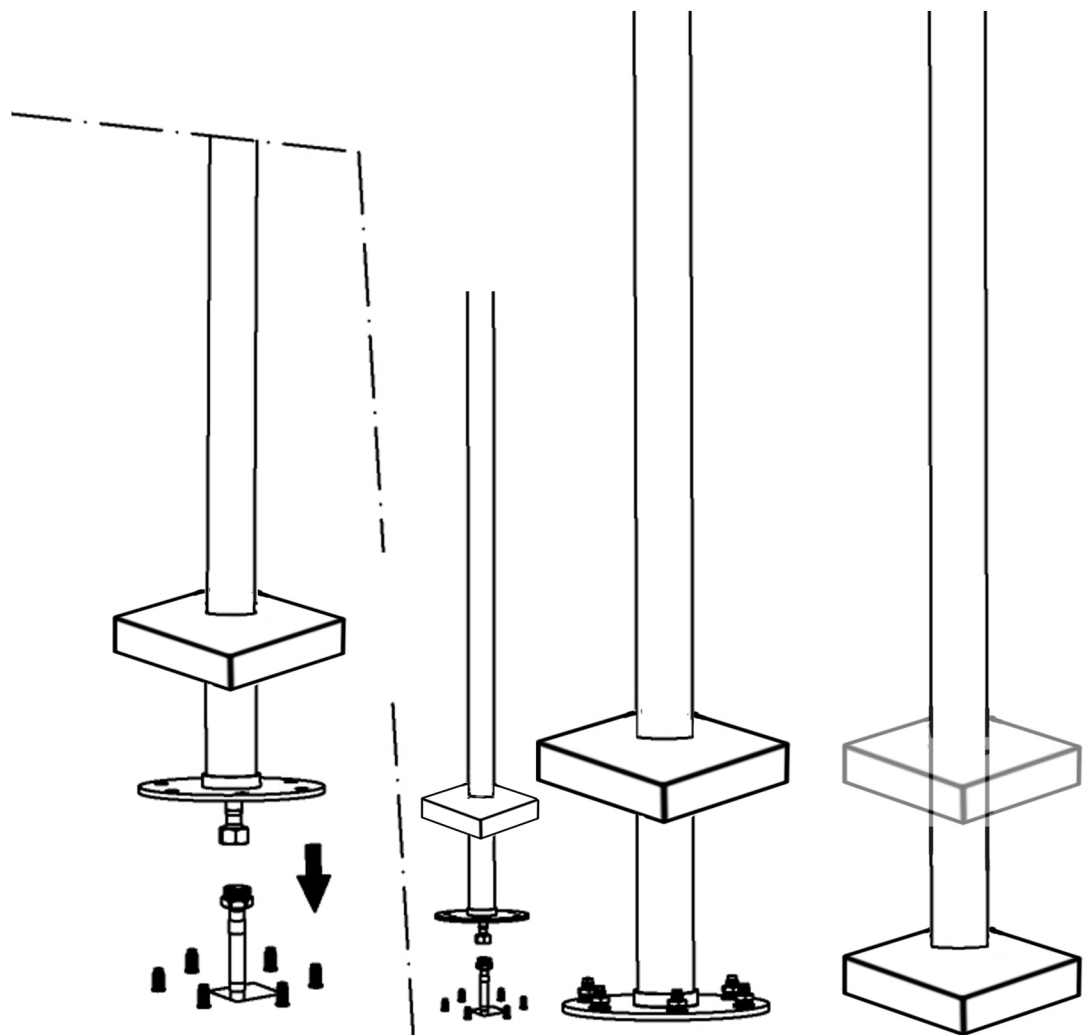

Cleaning & Care

To keep your outdoor shower looking its best and functioning properly, follow these maintenance tips:

1. Rinse after use:

After each use, rinse the shower with clean water to remove salt, sand, or pool chemicals. Wipe dry with a soft cloth to prevent water spots and mineral buildup.

2. Use mild cleaners:

For deeper cleaning, use a mild, non-abrasive liquid cleaner or a non-colored glass cleaner. Avoid acidic, bleach-based, or granular products that could damage the finish.

3. Avoid abrasives:

Do not use abrasive cleaners, polishing compounds, sandpaper, steel wool, or sharp tools.

4. Check for buildup:

Over time, mineral deposits or debris may accumulate in the showerhead or aerator, reducing water flow.

Unscrew the showerhead/aerator, rinse it thoroughly with clean water, and reinstall it.

5. Winter care:

In colder climates, disconnect the water supply and drain the shower before freezing temperatures to prevent damage.

**Please Do Not Return the Product to the Store.
Contact us with any questions.**