

DIMENSIONS GUIDE

MODEL NUMBER:1580VB-60-201-242-926-SR

SEMI-RECESSED SINK

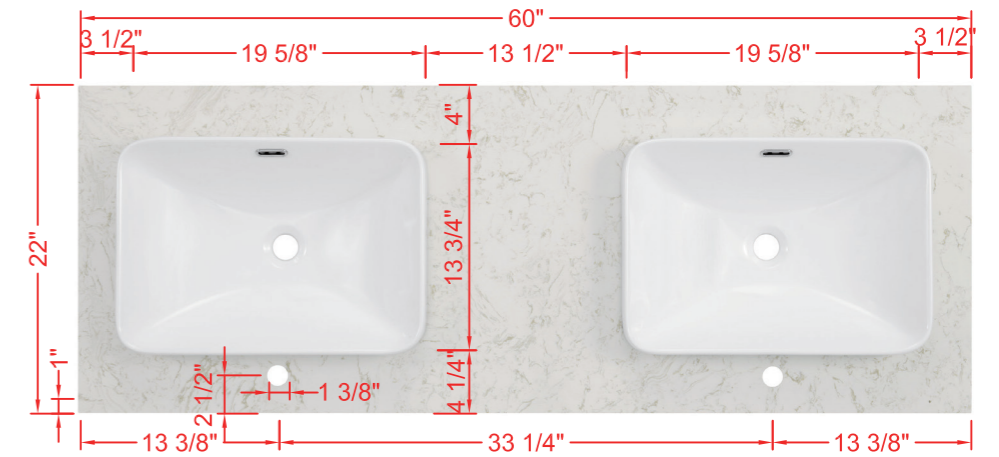
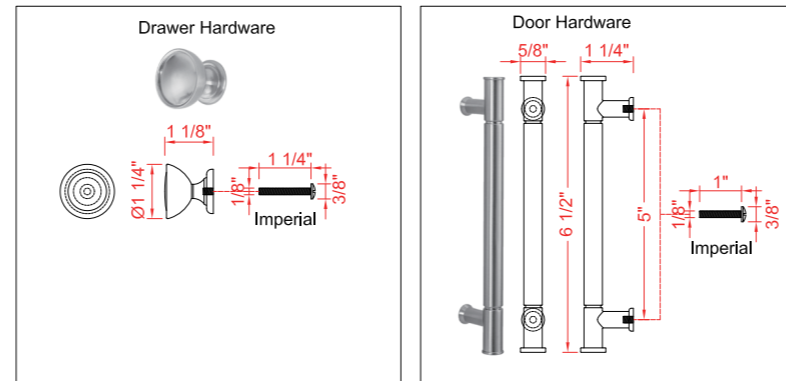
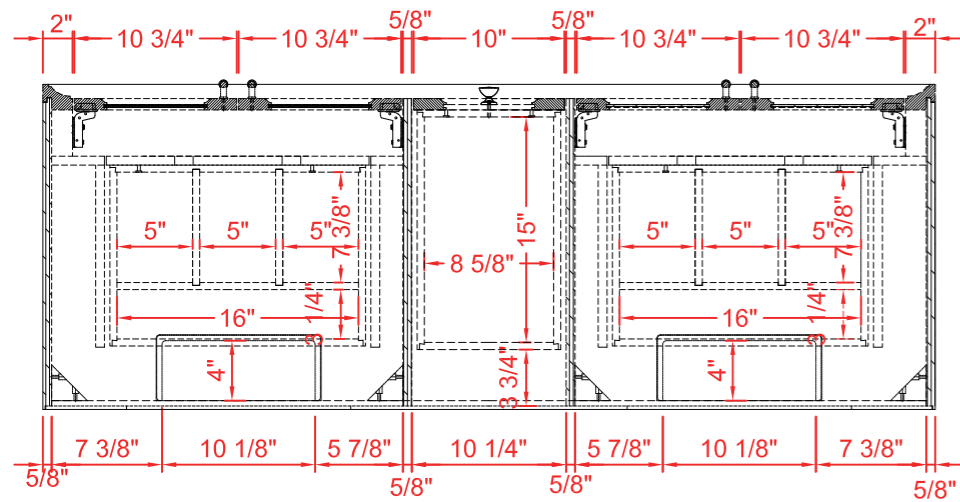

TOP VIEW

Product Net weight (W/O Top):165lbs.
Product packed Gross weight (W/O Top):218lbs.
Packed product Dimensions:
62.5in. W x 24.75in. D x 39.5in. H

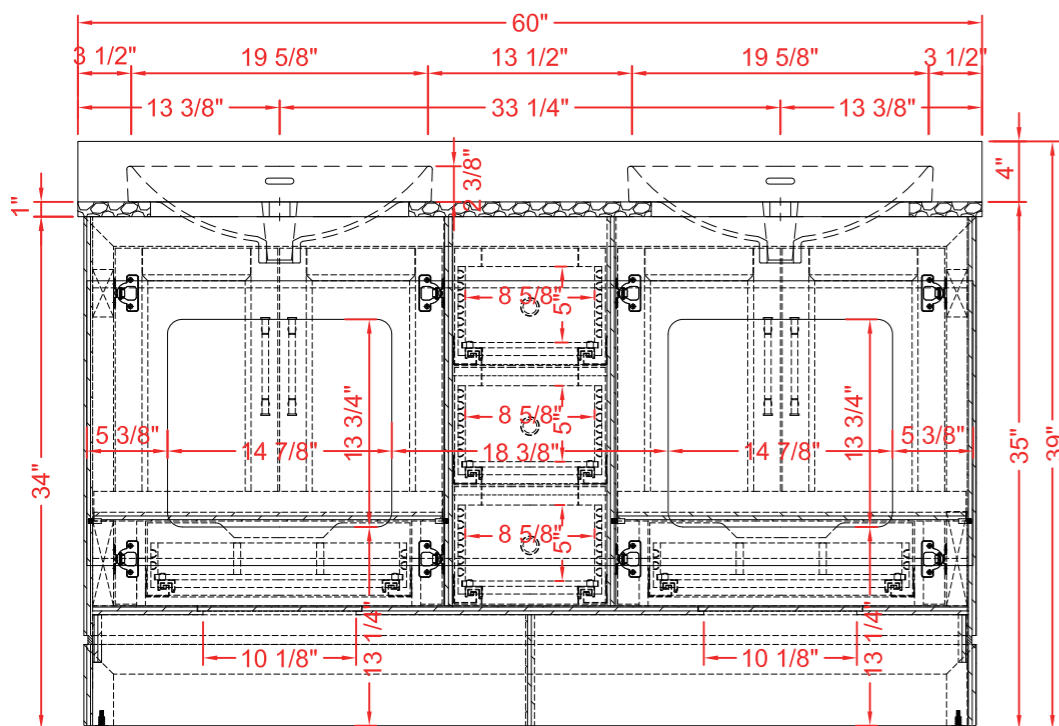

FRONT VIEW

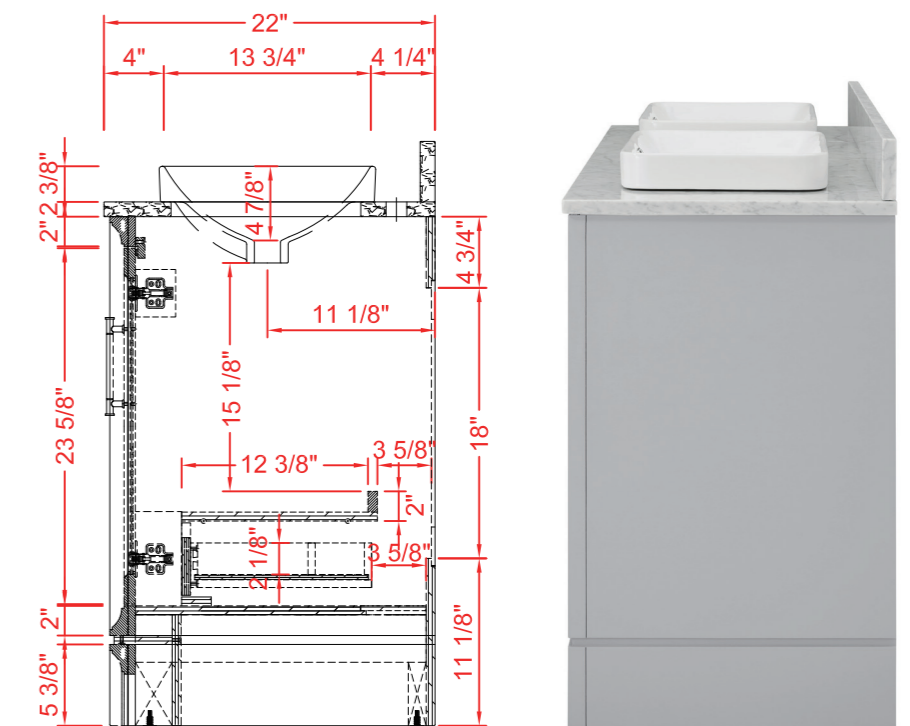

SIDE VIEW

DIMENSIONS GUIDE

MODEL NUMBER: 1580VB-60-201-242-926-UM

UNDERMOUNT SINK

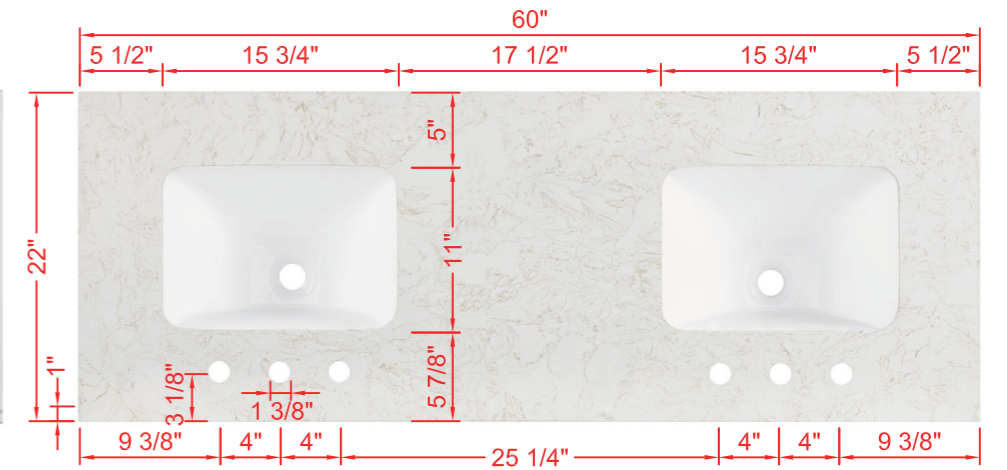
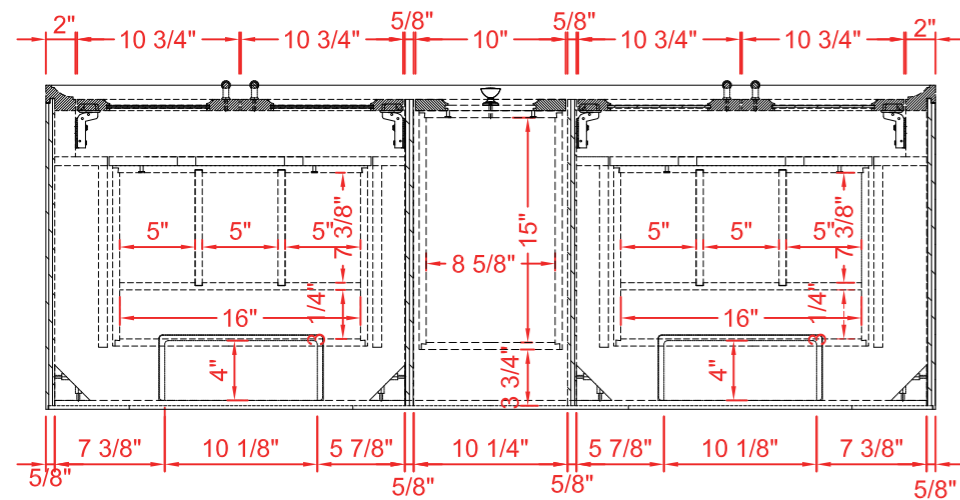

TOP VIEW

Product Net weight (W/O Top): 165lbs.
 Product packed Gross weight (W/O Top): 218lbs.
 Packed product Dimensions:
 62.5in. W x 24.75in. D x 39.5in. H

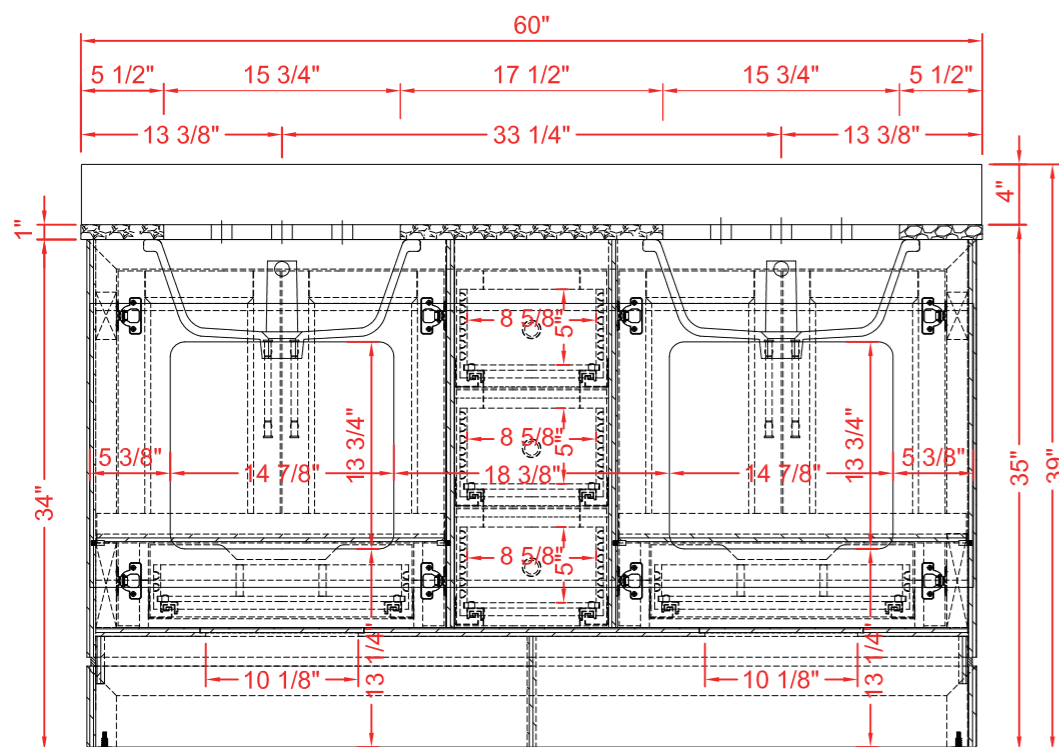
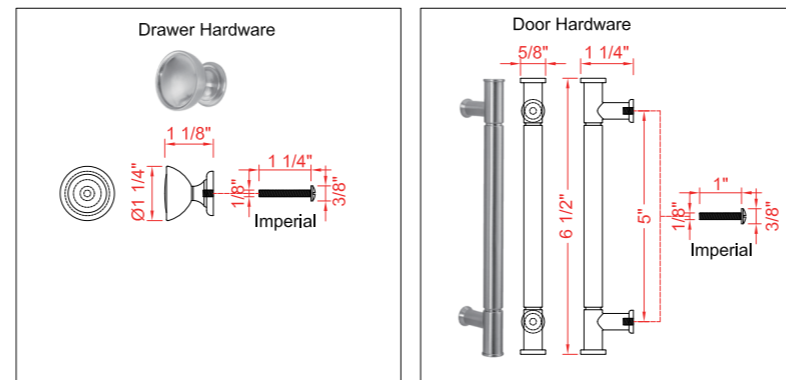

FRONT VIEW

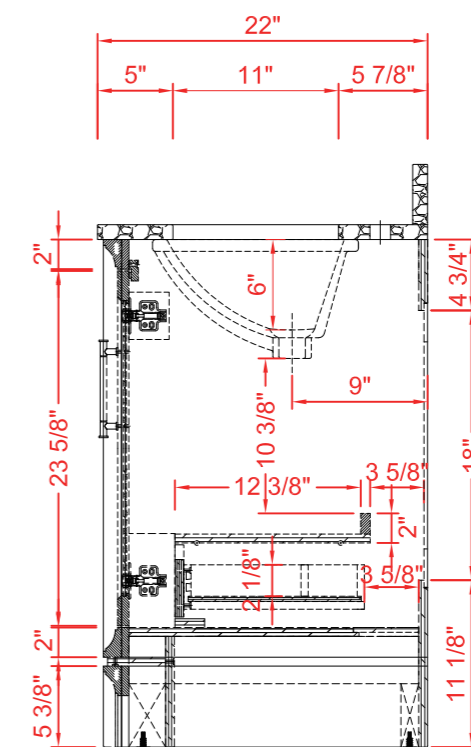

SIDE VIEW

