

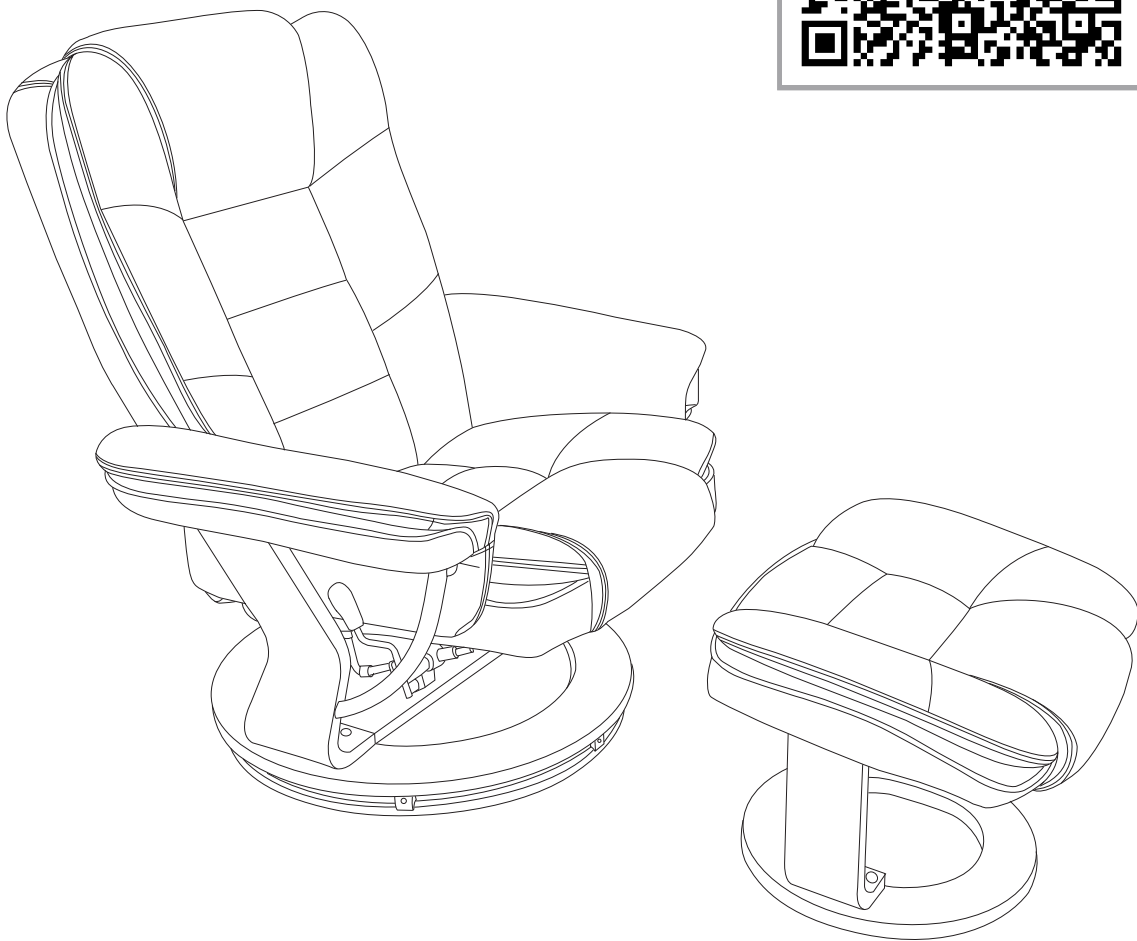

Assembly Instructions

Scan QR Code for Assembly Video







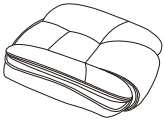
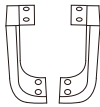
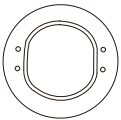

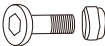

CUSTOMER'S SERVICE: snugservice@outlook.com

Component List

Part No.	Picture	Description	Qty
A		Folded Chair	1
B		Armrest (R+L)	2
C		Footrest Cushion	1
D		Footrest Leg	2
E		Footrest Round Base	1

Hardware List

Label	Picture	Description	Qty
H1		M6*20mm Bolt	4
H2		M6*35mm Bolt	4
H3		M8*25mm Bolt	2
H4		M8*35mm Bolt	4
H5		6.5*18*1.5mm Small Flat Washer	4
H6		8.5*22*2mm Large Flat Washer	4
H7		M6 Allen Wrench	1
H8		13mm Spanner	1

Assembly Preparation



- Unpack all hardware bags and components to confirm you have everything



- Read the instructions completely before starting



- Assembly requires **2 adults**





- Assemble on a clean, non-marring surface (e.g., packing foam)



- Keep all packaging until assembly is finished

Assembly Step

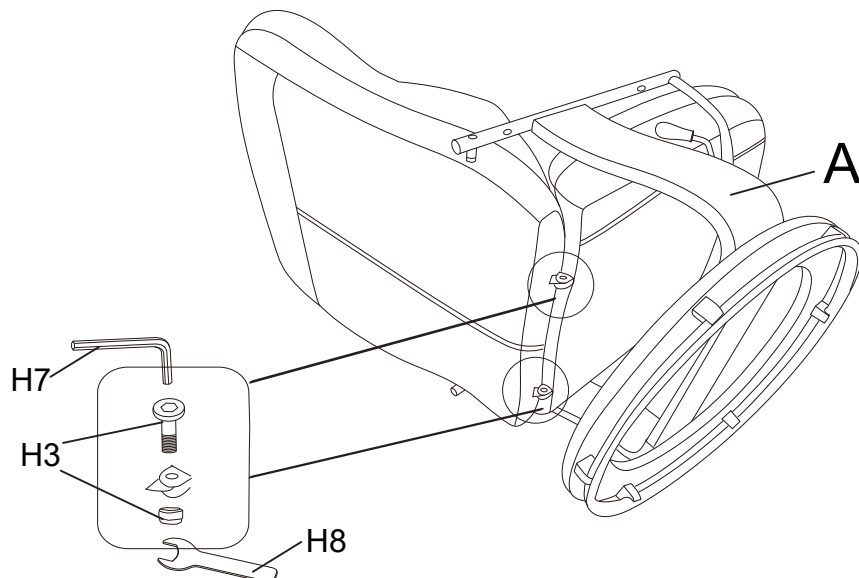

Step 1 Secure the Chair Backrest

-  H3 2pcs
-  H7
-  H8



Take out Folded Chair (A) and Bolts (H3). Use Allen Wrench (H7) and Spanner (H8) to secure the backrest.

Step 2 Install the Armrests

-  H2 4pcs
-  H7

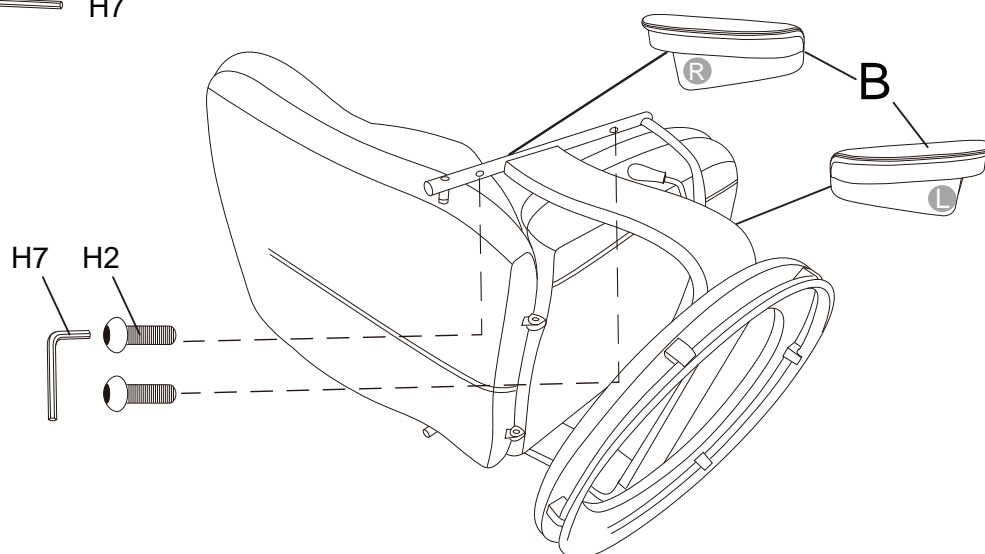

Please check the "R" (right) and "L" (left) labels on the armrests to install them correctly.



Use the Allen Wrench (H7) to attach the Armrests R+L (B) to the chair body using Bolts (H2).

Assembly Step

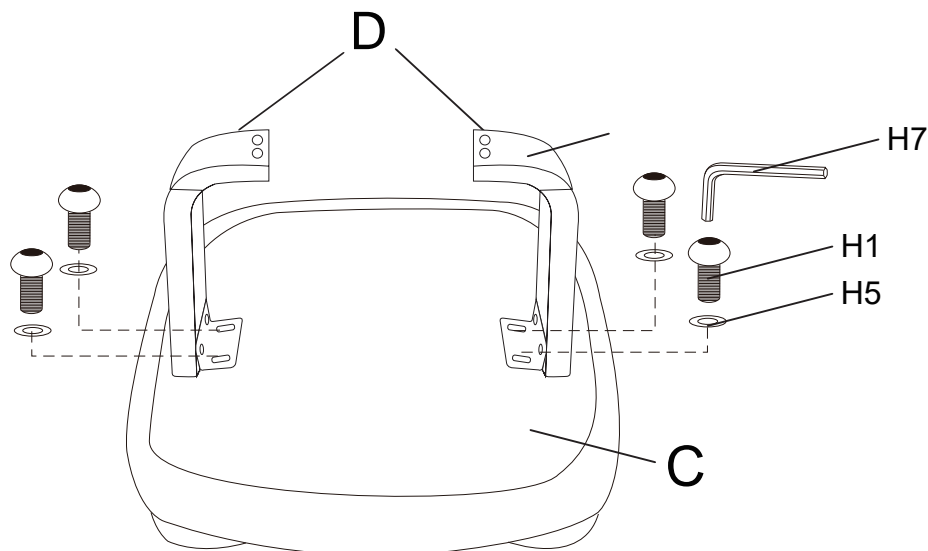

Step 3 Install the Footrest Legs

-  H1 4pcs
-  H5 4pcs
-  H7



Use the Allen Wrench (**H7**) to attach the Footrest Legs (**D**) to the Footrest Cushion (**C**) using Bolts (**H1**) and Small Flat Washers (**H5**).

Step 4 Install the Footrest Round Base

-  H4 4pcs
-  H6 4pcs
-  H7

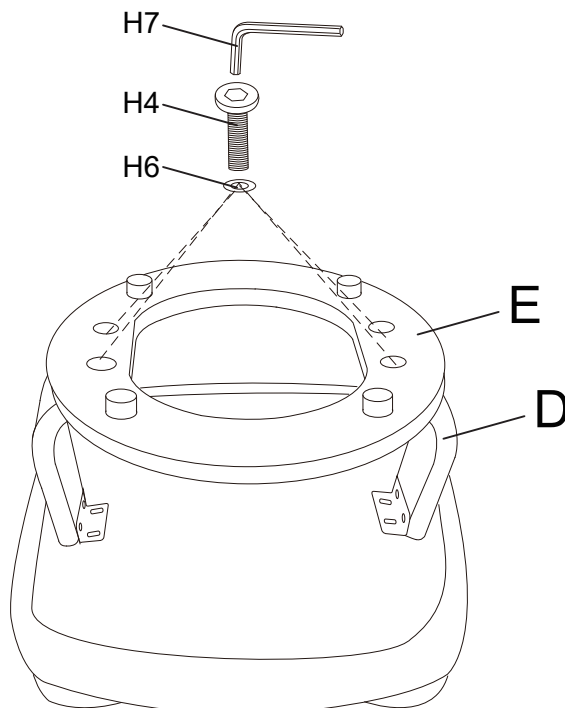

Use the Allen Wrench (**H7**) to attach the Round Base (**E**) to the Legs (**D**) using Bolts (**H4**) and Large Flat Washers (**H6**).

Assembly Step

Step 5 Installation Complete

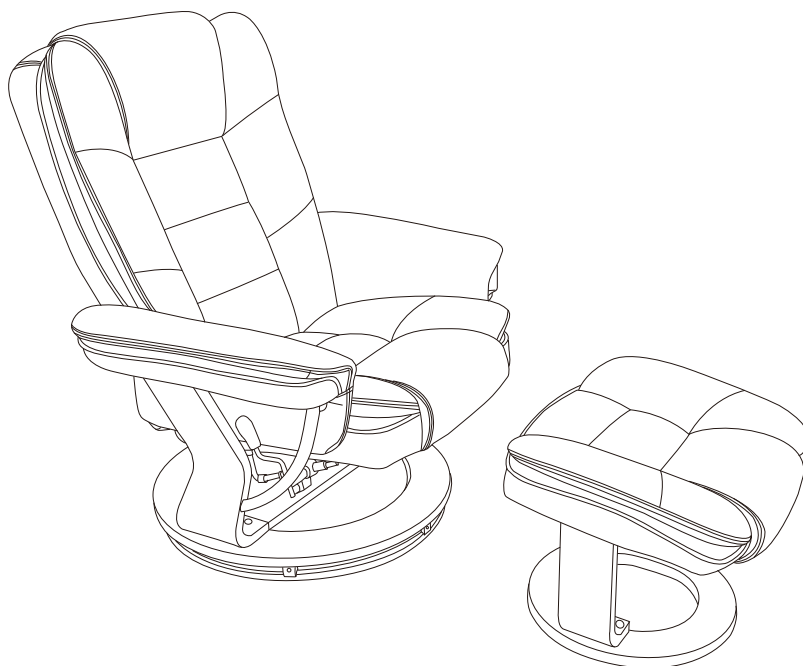

Place the chair on a soft surface. Make sure all legs touch the floor evenly.

Care & Maintenance



- **Do not** place hot items directly on the furniture surface.



- **Do not** clean the furniture with harsh cleansers or polish.



- **Do not** place the furniture under direct sunlight.



- **Do not** place the furniture near heating or cooling vents.



- **Do not** write on the furniture without a padded barrier to protect the surface.



- **Do not** use or place the furniture outdoors; for indoor use only.



- Stains may be removed with a mild soap solution and a damp cloth.



- Dust the furniture and wipe up spills using a clean, non-colored, lint-free cloth.

Warning Information



- To prevent the chair from tipping over, sit down gently and **DO NOT** jump or throw yourself onto it. Move the chair into the reclining position slowly, and ensure no children or pets are nearby.



- **DO NOT** allow children to play on or around the chair, especially when it is reclined.



- **Fully close** the recliner before standing up.



- To eliminate the risk of tipping over, **DO NOT** sit on the armrests.



- This chair is designed for use by **one adult** at a time.



- Maximum weight capacity: **300 lbs.**