

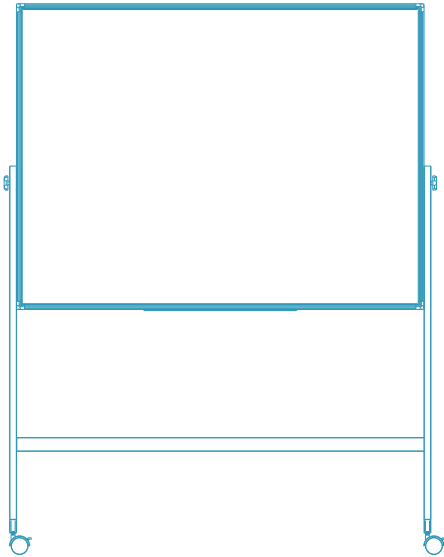







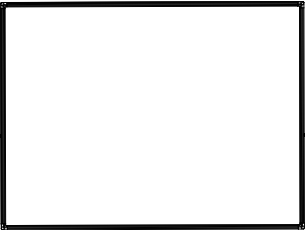

✉ HJ-Customer-Service@outlook.com

☎ (909)637-7665 | (909)637-7593

EST 9:00AM--17:00PM

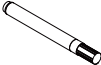

## Magnetic Dry Erase Board

<p>①</p>  <p>X1</p>	<p>②</p>  <p>X4</p>	<p>③</p>  <p>X2</p>	<p>④</p>  <p>X1</p>	
	<p>⑤</p>  <p>X4</p>	<p>⑥</p>  <p>X1</p>	<p>⑦</p>  <p>X2</p>	
<p>⑧</p>  <p>X1</p>	<p>⑨</p>  <p>X1</p>	<p>⑩</p>  <p>X6</p>	<p>⑪</p>  <p>X1</p>	<p>⑫</p>  <p>X3</p>

## Installation Diagram:

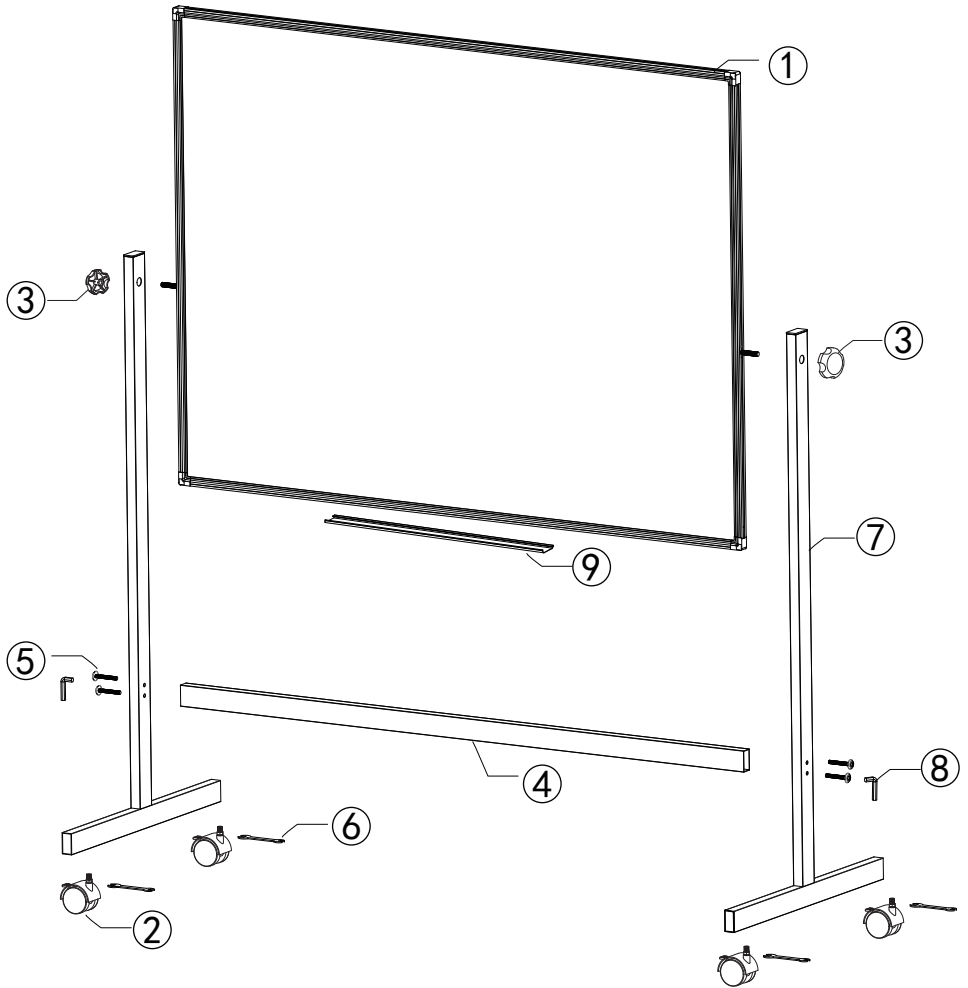

### Pen holder installation steps:

1. Insert the pen holder into the frame slot at an angle, as shown in Figure A;
2. Lay the pen holder flat when the upper edge entered the slot, as shown in Figure B;
3. The pen holder can be removed when tilted upward.

