

# Dimension/Specification

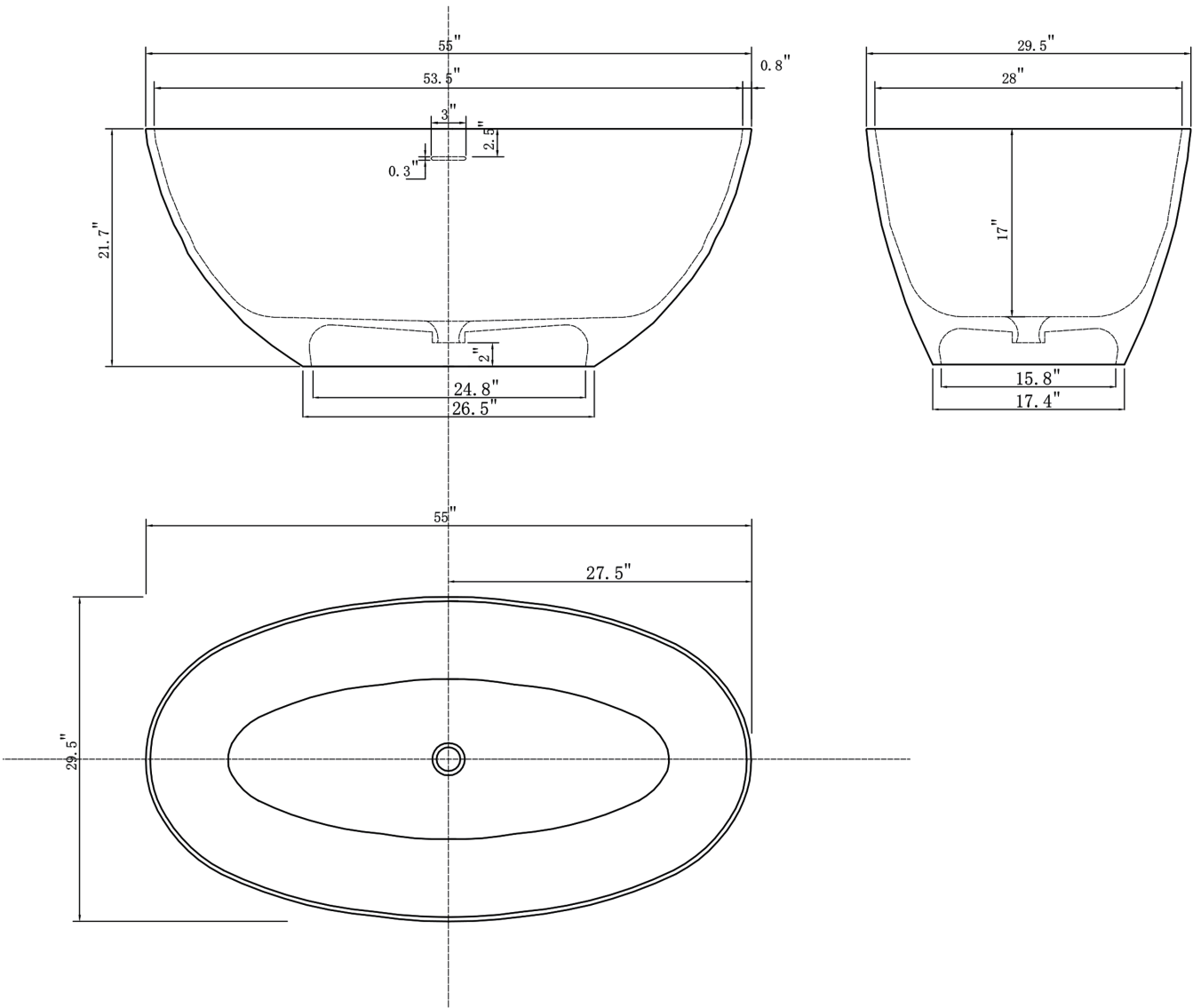

**Sku RX-S02-55MB**