













| NO. | DESCRIPTION | DRAWING | QTY. |
|-----|----------------------|---|--------|
| A | BACK REST CUSHION |  | 1 PC |
| B | CHAIR FRAME - LEFT |  | 1 PC |
| C | CHAIR FRAME - RIGHT |  | 1 PC |
| D | FRONT RAIL - LONG |  | 1 PC |
| E | BACK RAIL - SHORT |  | 1 PC |
| F | CUSHION SEAT |  | 1 PC |
| G | 45MM JCBC BOLT |  | 10 PCS |
| H | 1/4" SPRING WASHER |  | 10 PCS |
| I | WOOD DOWEL M8 x 30MM |  | 2 PCS |
| J | JCBC/W M7 x 25MM |  | 4 PCS |
| K | ALLEN KEY |  | 1 PC |
| L | WOOD BUTTOM |  | 2 PCS |



COMPLETED DINING CHAIR

STEP 1

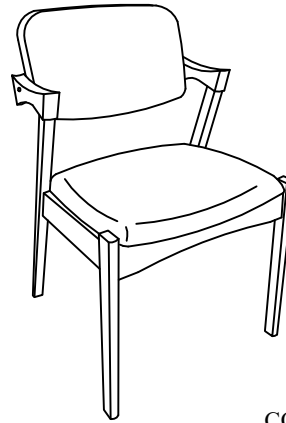
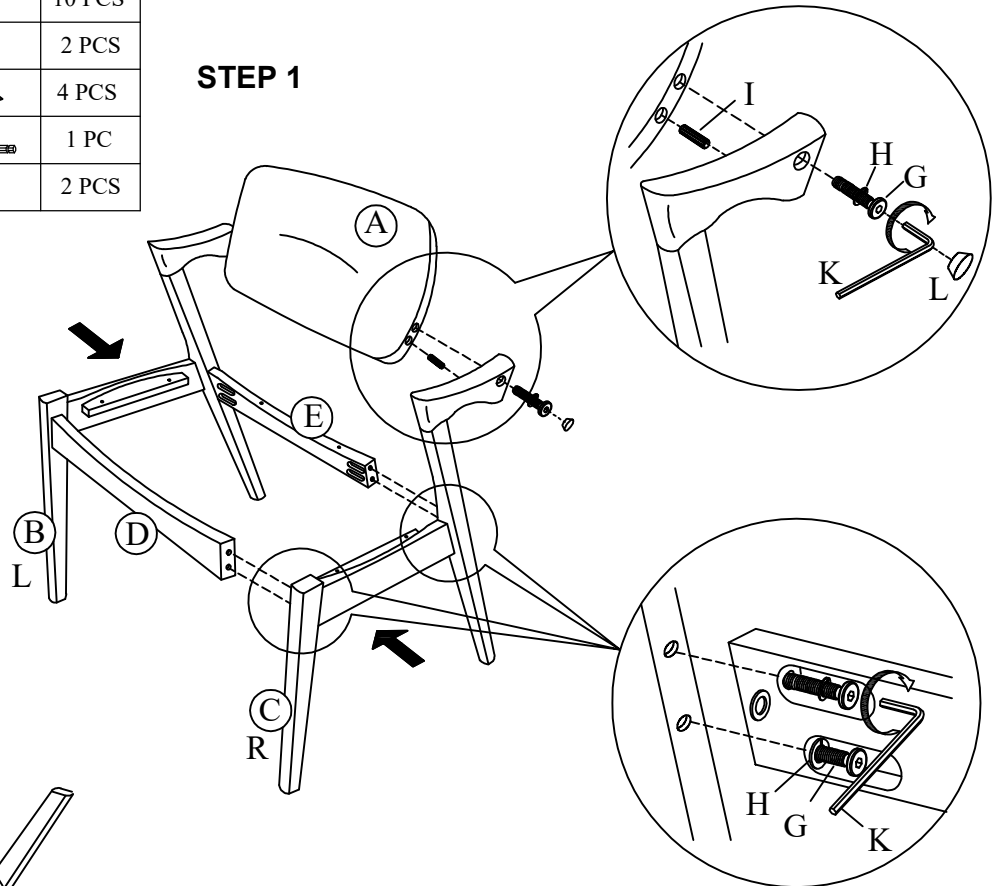

STEP 2

