

# ASSEMBLY INSTRUCTIONS

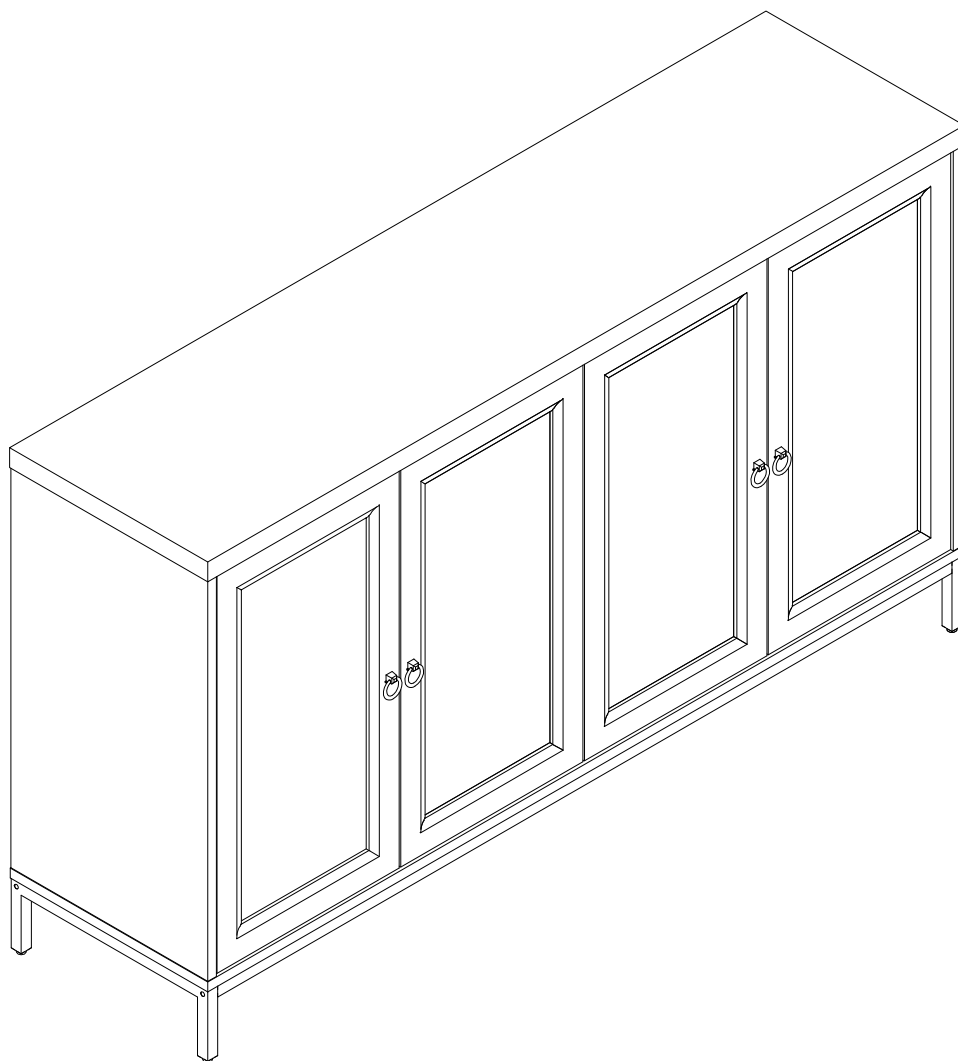

NOTE: 50% TIGHTEN BEFORE FIXING ALL BOLTS

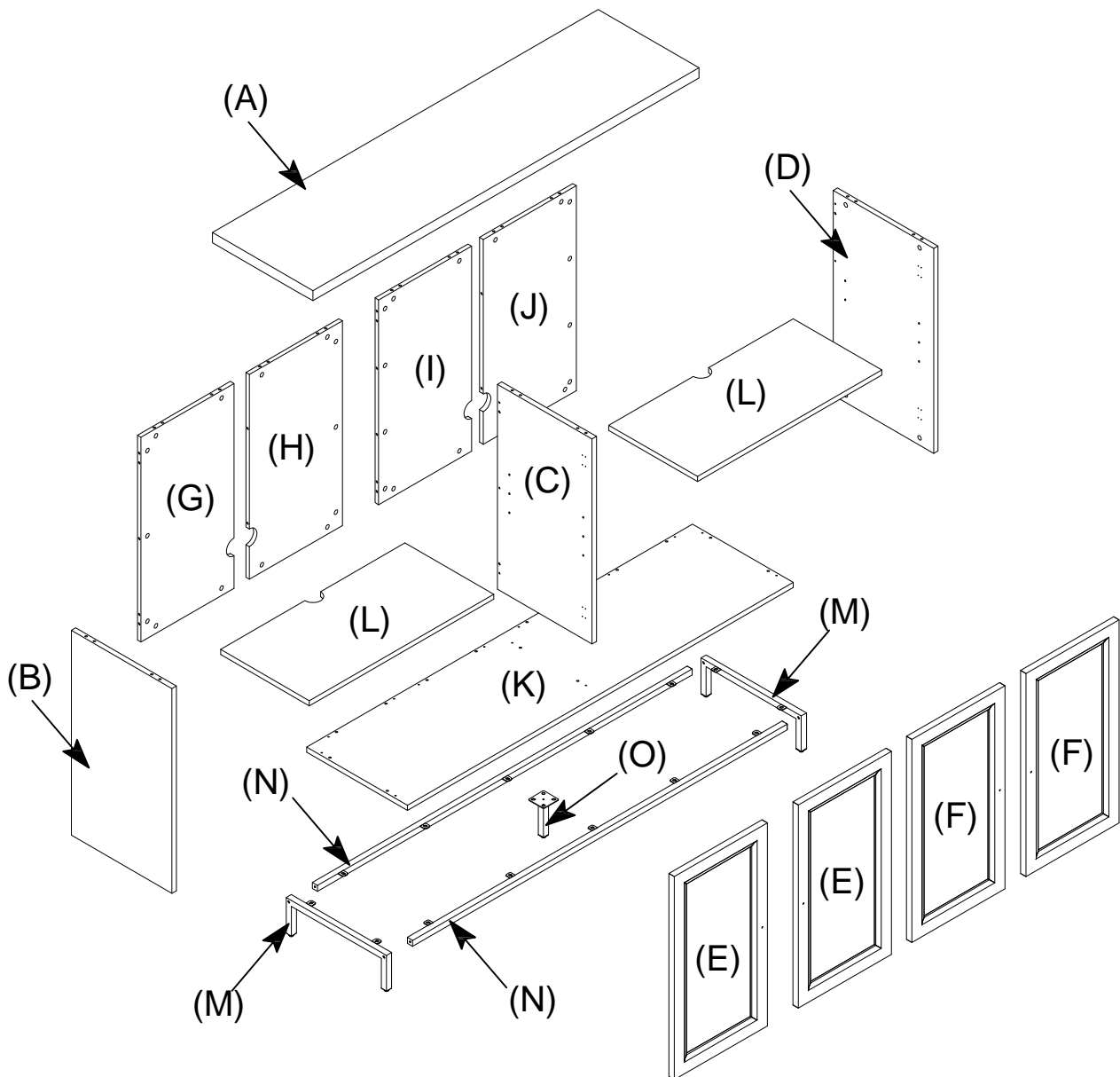

## Notice:

1. 50% Tighten before fixing all screws, Allen wrench is recommended instead of an electric drill.
2. Place the item on a flat ground to adjust and make sure it remains stable.
3. Tighten up all screws with tools gradually.
4. If the screws are not aligned with holes during assembly, please loosen all the other screws to 50% and continue the assembly process.
5. If the item is not stable, please loosen all the screws, adjust it on a flat ground and tighten up all screws again.
6. Note : If one or some screws are fully tightened during assembly, chances are the others will not be aligned with holes. In addition, all the holes are designed to be relatively larger to provide more space for the adjustment of the screws.

# PART LIST

A

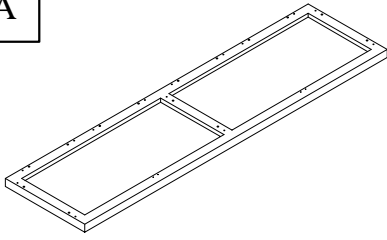

Top Panel (1PC)

B



Left Panel (1PC)

C



Center Panel (1PC)

D

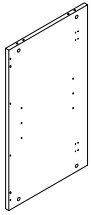

Right Panel (1PC)

E



Left Front Panel (2PCS)

F



Right Front Panel (2PCS)

G

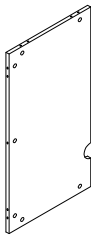

Left Back Panel - Left (1PC)

H



Left Back Panel - Right (1PC)

I

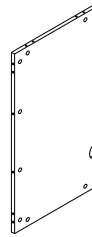

Right Back Panel - Left (1PC)

J

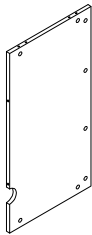

Right Back Panel - Right (1PC)

K

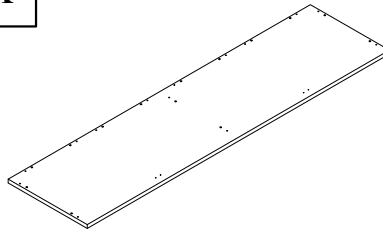

Bottom Panel (1PC)

L

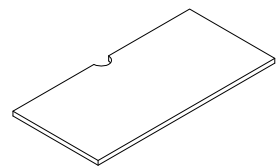

Shelf (2PCS)

M

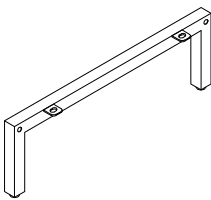

Leg Frame (2PCS)

N

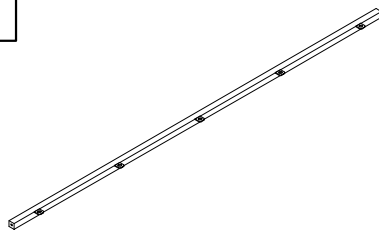



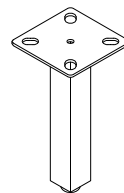

Sketcher (2PCS)

O

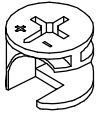
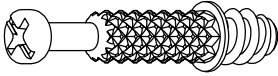
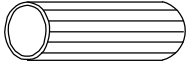
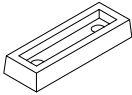

Support Leg (1PC)

# HARDWARE LIST

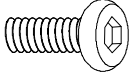
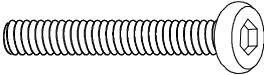
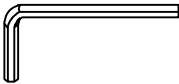
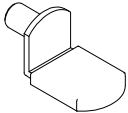
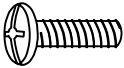
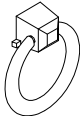
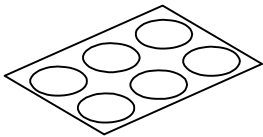
<p>1</p>  <p><b>Cam Lock (42PCS)</b></p>	<p>2</p>  <p><b>Cam Bolt (42PCS)</b></p>	<p>3</p>  <p><b>Ø8x30mm Wood Dowel (40PCS)</b></p>
<p>4</p>  <p><b>Door Stopper (4PCS)</b></p>	<p>5</p>  <p><b>M3x15mm Flat Head Screw (8PCS)</b></p>	<p>6</p>  <p><b>Inset Overlay Hinges (4PCS)</b></p>
<p>7</p>  <p><b>Full Overlay Hinges (4PCS)</b></p>	<p>8</p>  <p><b>M3.5x15mm Flat Head Screw (48PCS)</b></p>	<p>9</p>  <p><b>Bolt 1/4" x 12mm (18PCS)</b></p>
<p>10</p>  <p><b>Bolt 1/4" x 30mm (4PCS)</b></p>	<p>11</p>  <p><b>Allen Key 4mm (1PC)</b></p>	<p>12</p>  <p><b>Shelf Support (8PCS)</b></p>
<p>13</p>  <p><b>Ø5/32"x23mm Bolt with Screw Head (4PCS)</b></p>	<p>14</p>  <p><b>Handle (4PCS)</b></p>	<p>15</p>  <p><b>Sticker (42PCS)</b></p>

# CARTON CONTENT:

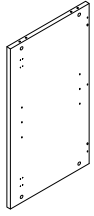

**B** Left Panel (1PC)

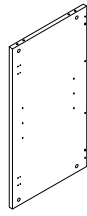

**C** Center Panel (1PC)

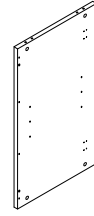

**D** Right Panel (1PC)

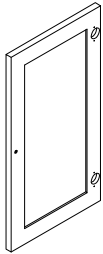

**E** Left Front Panel (2PCS)

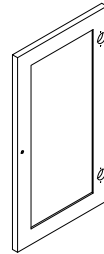

**F** Right Front Panel (2PCS)



**G** Left Back Panel - Left (1PC)

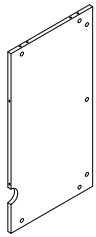

**H** Left Back Panel - Right (1PC)

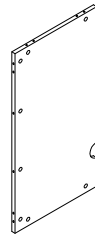

**I** Right Back Panel - Left (1PC)



**J** Right Back Panel - Right (1PC)

## CARTON CONTENT:

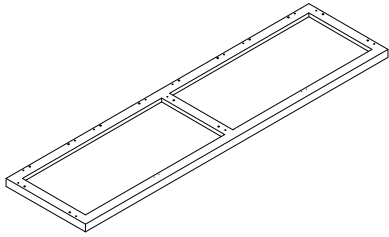

**A** Top Panel (1PC)

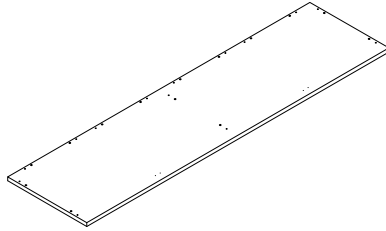

**K** Bottom Panel (1PC)

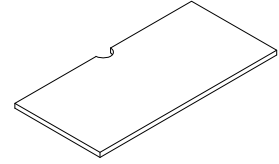

**L** Shelf (2PCS)

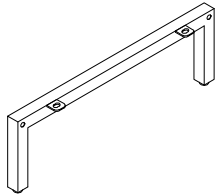

**M** Leg Frame (2PCS)

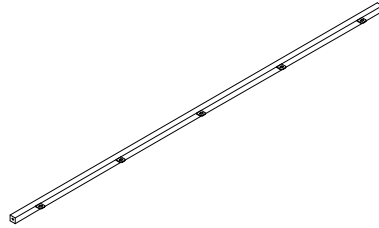



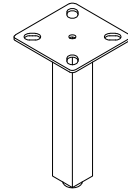

**N** Sketcher (2PCS)

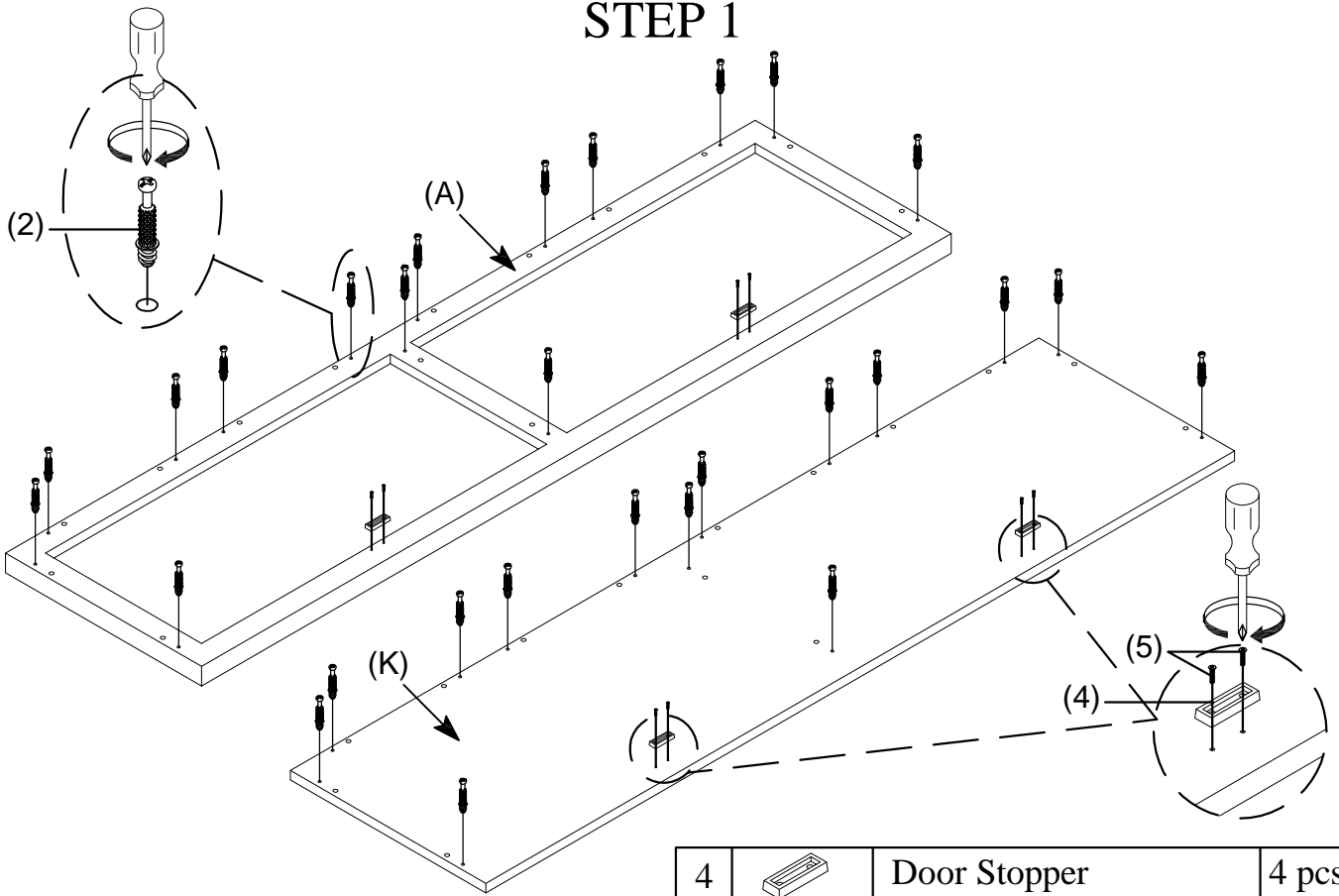

**O** Support Leg (1PC)

# STEP 1



2		Cam Bolt	28 pcs	4		Door Stopper	4 pcs
				5		M3x15mm Flat Head Screw	8 pcs

# STEP 2

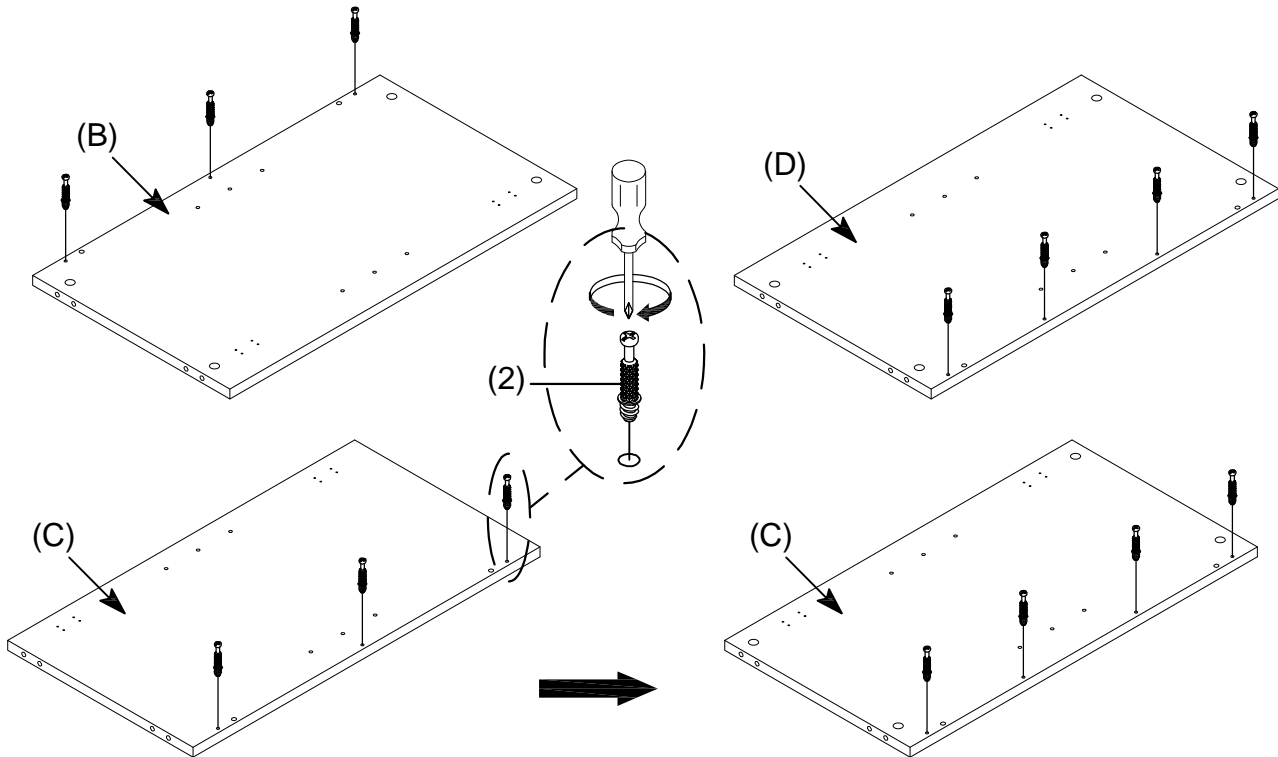

2		Cam Bolt	14 pcs
---	---	----------	--------

### STEP 3

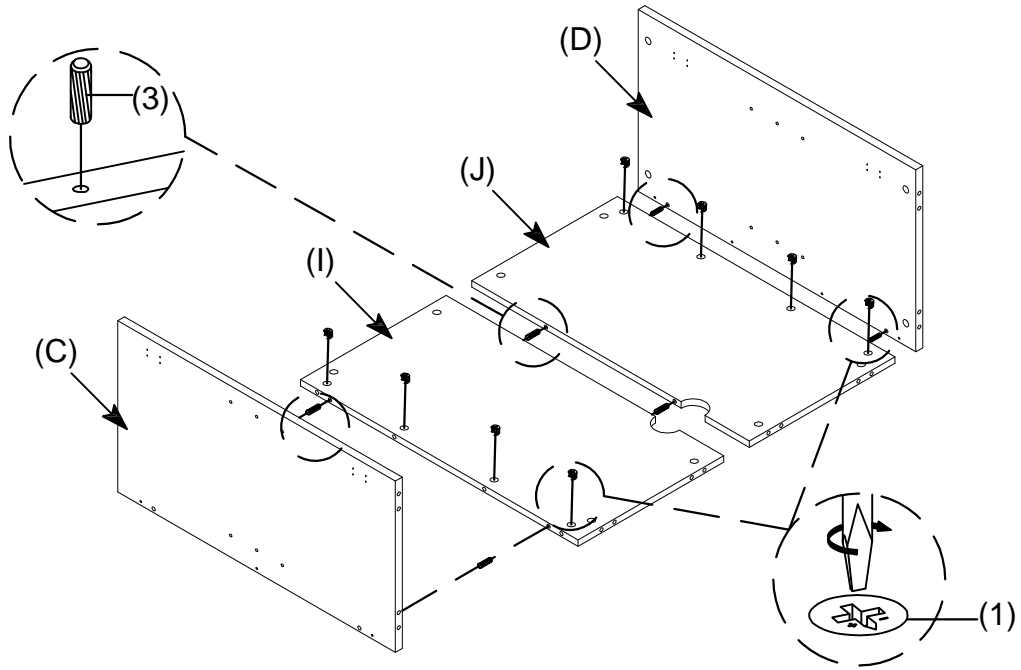

1		Cam Lock	8 pcs	3		Ø8x30mm Wood Dowel	6 pcs
---	---	----------	-------	---	---	--------------------	-------

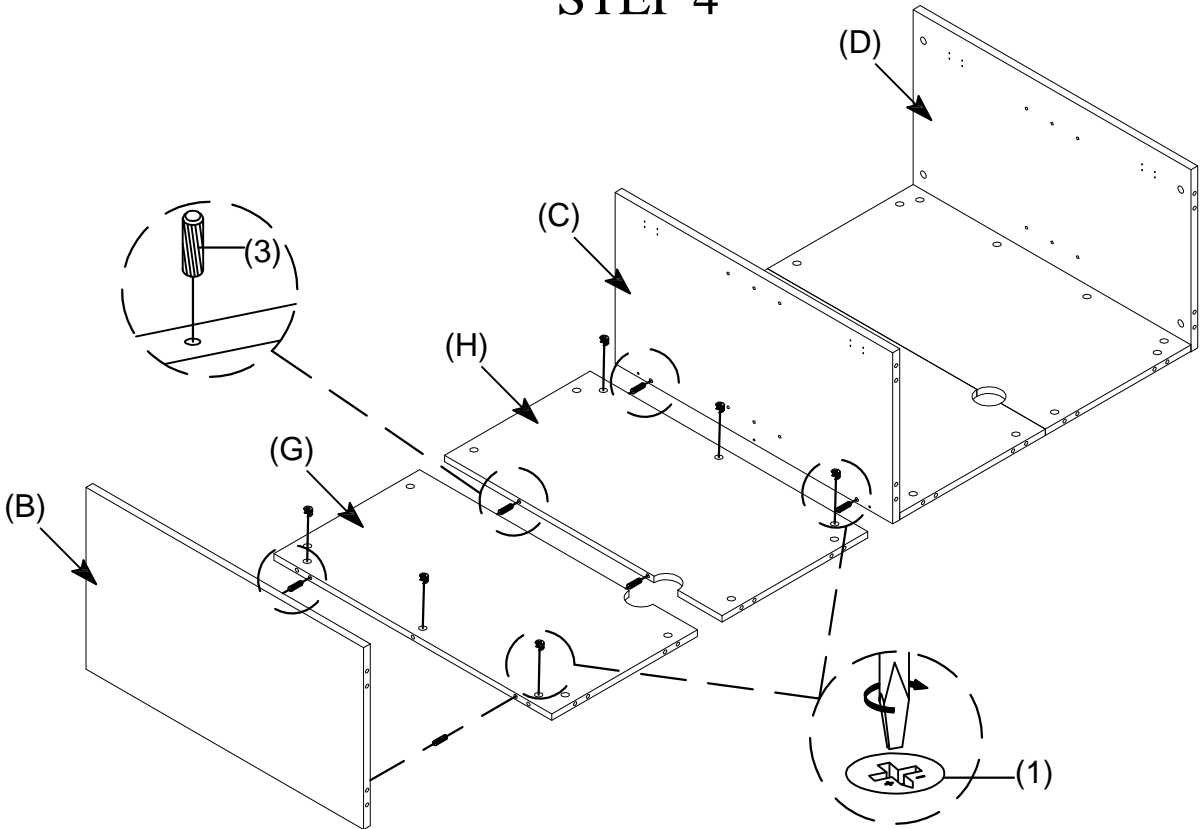

### STEP 4



1		Cam Lock	6 pcs	3		Ø8x30mm Wood Dowel	6 pcs
---	---	----------	-------	---	---	--------------------	-------

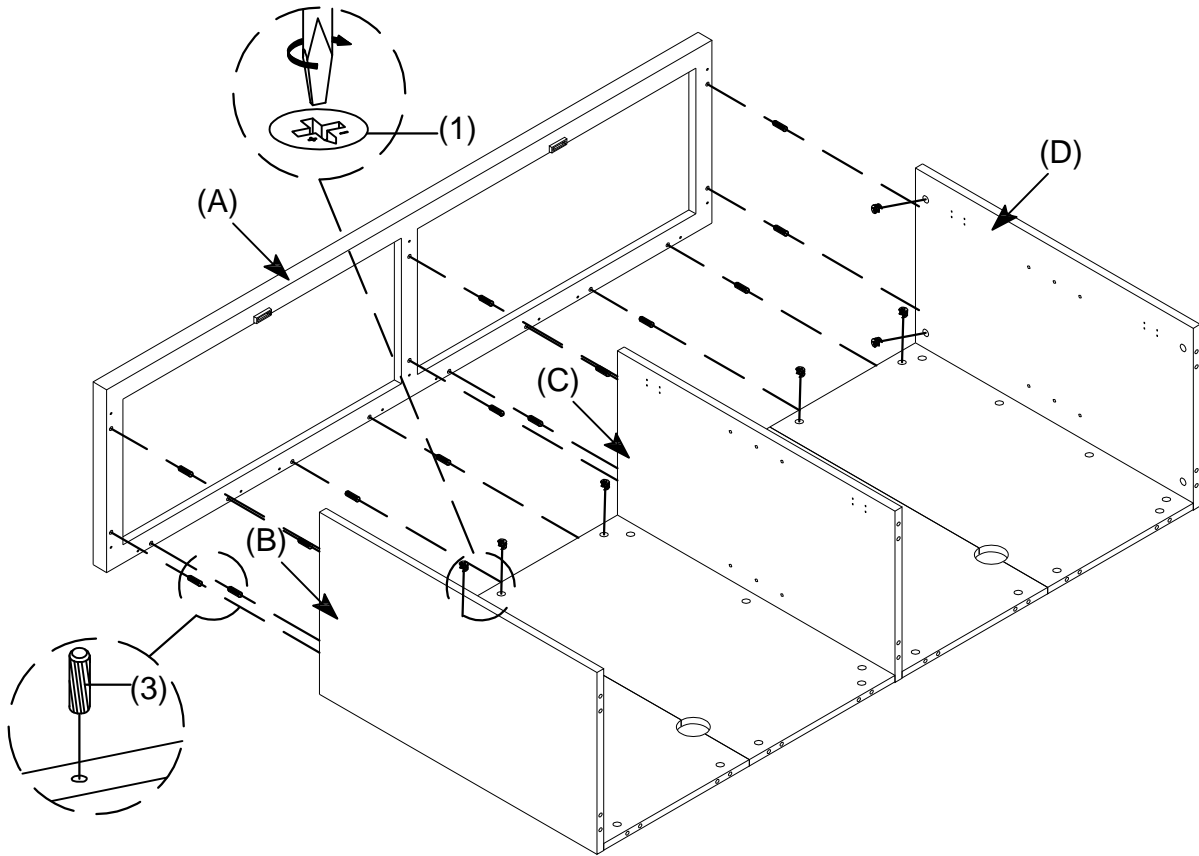

## STEP 5

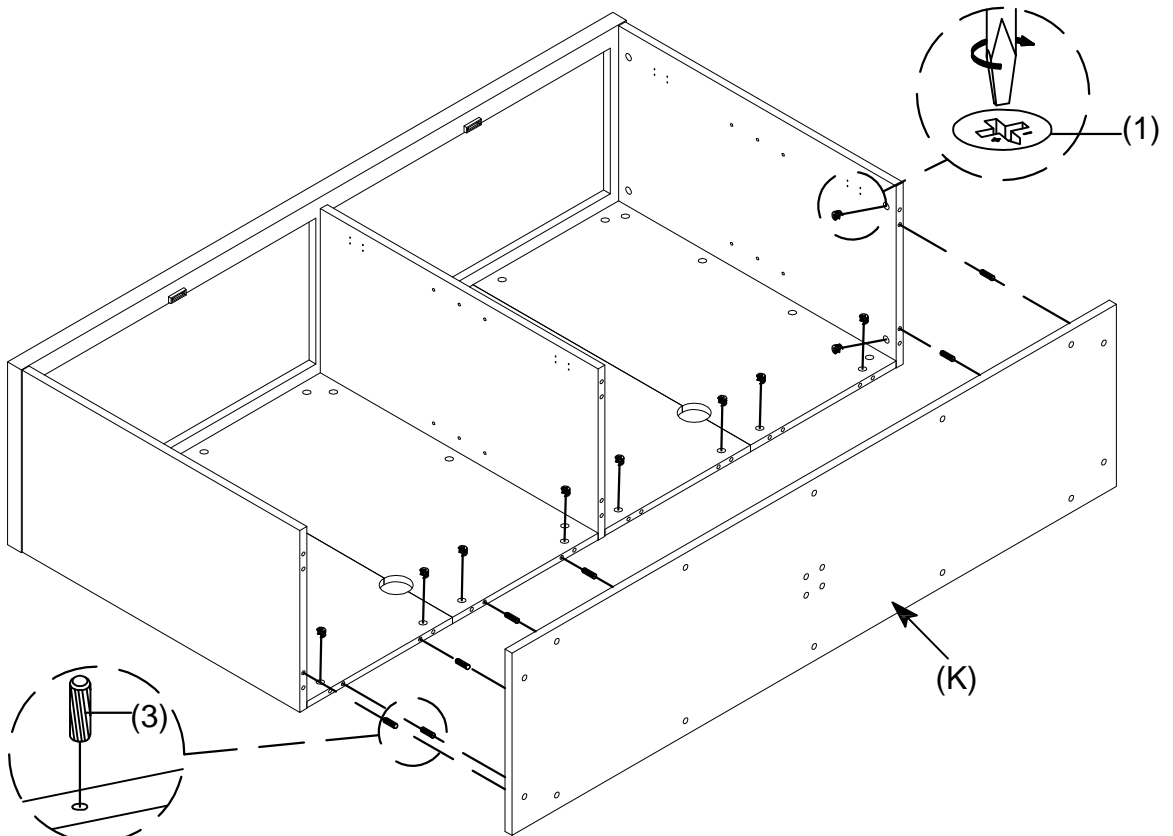

1		Cam Lock	14 pcs	3		Ø8x30mm Wood Dowel	14 pcs
---	---	----------	--------	---	---	--------------------	--------

## STEP 6



1		Cam Lock	14 pcs	3		Ø8x30mm Wood Dowel	14 pcs
---	---	----------	--------	---	---	--------------------	--------

# STEP 7

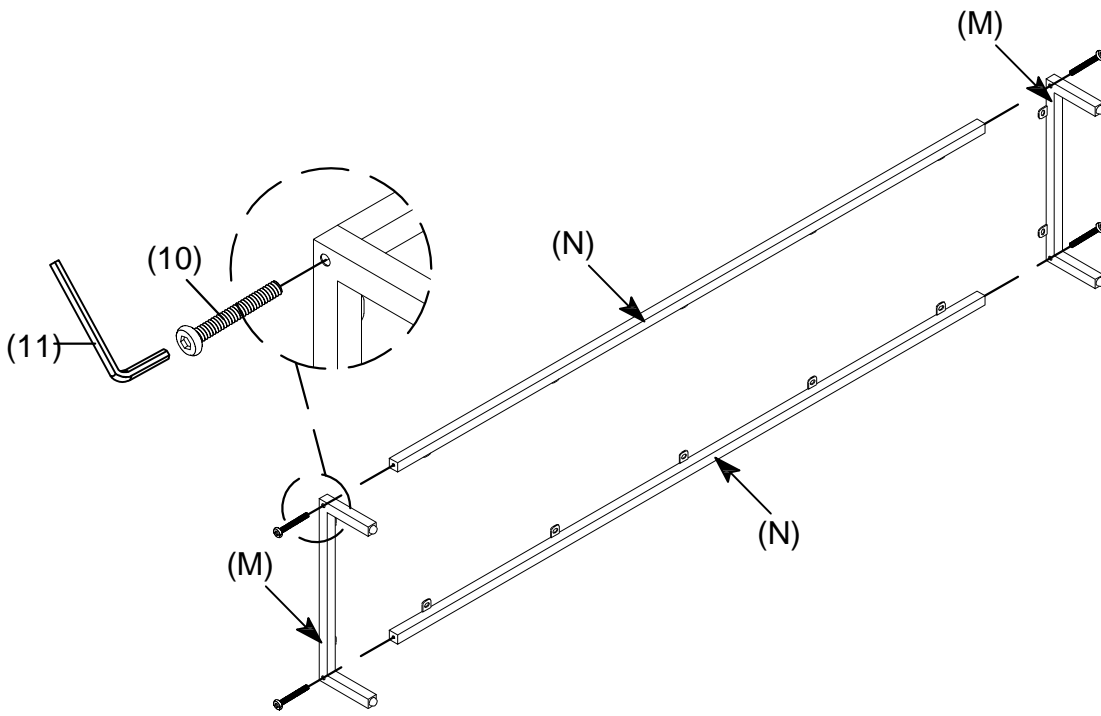

10		Bolt 1/4" x 30mm	4 pcs	11		Allen Key 4mm	1 pc
----	--	------------------	-------	----	--	---------------	------

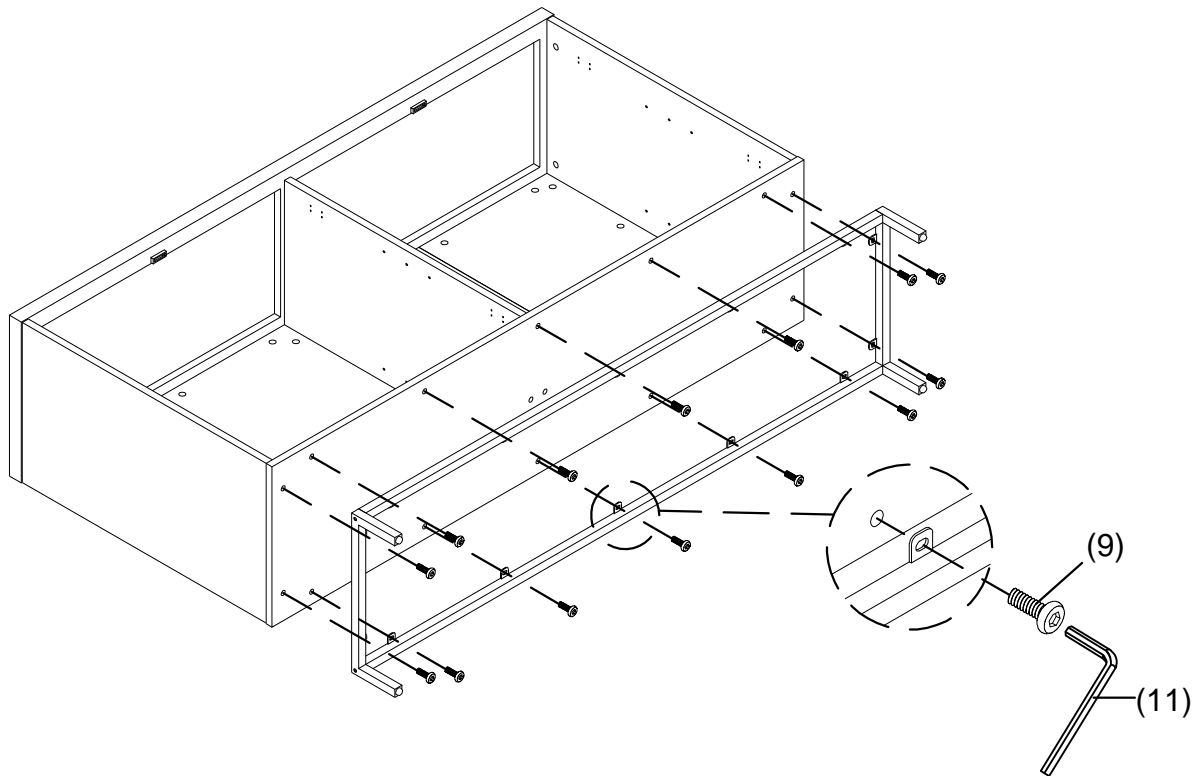

# STEP 8



9		Bolt 1/4" x 12mm	14 pcs	11		Allen Key 4mm	1 pc
---	--	------------------	--------	----	--	---------------	------

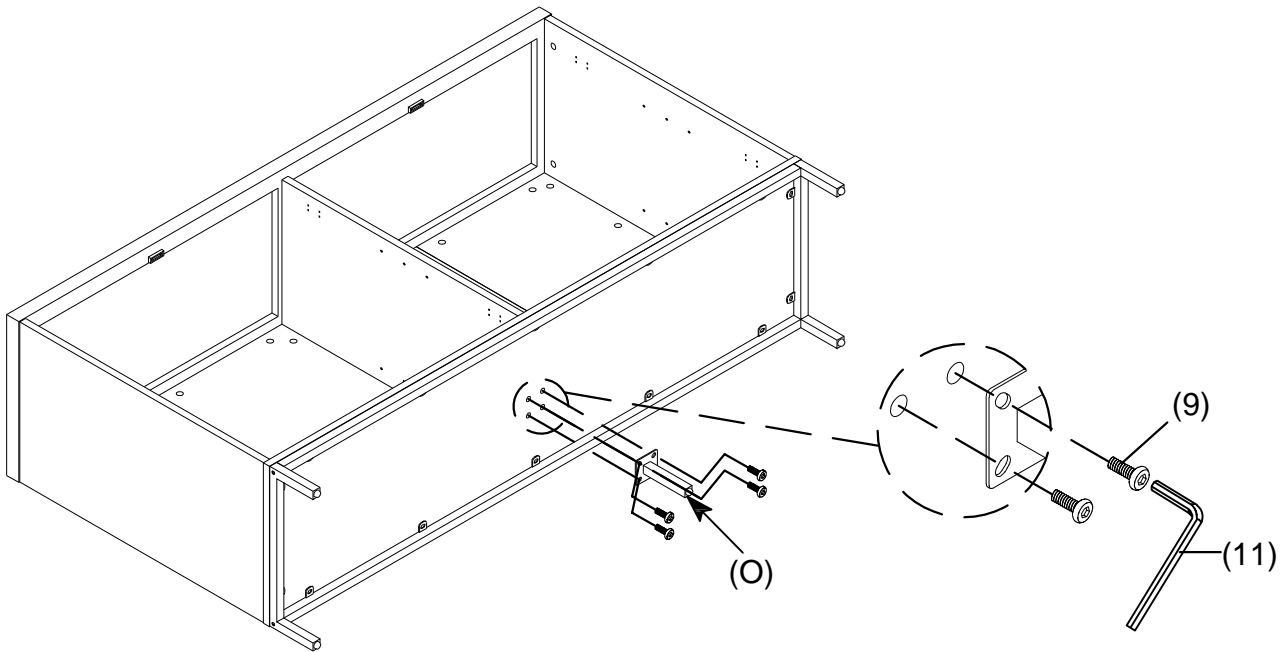



## STEP 9

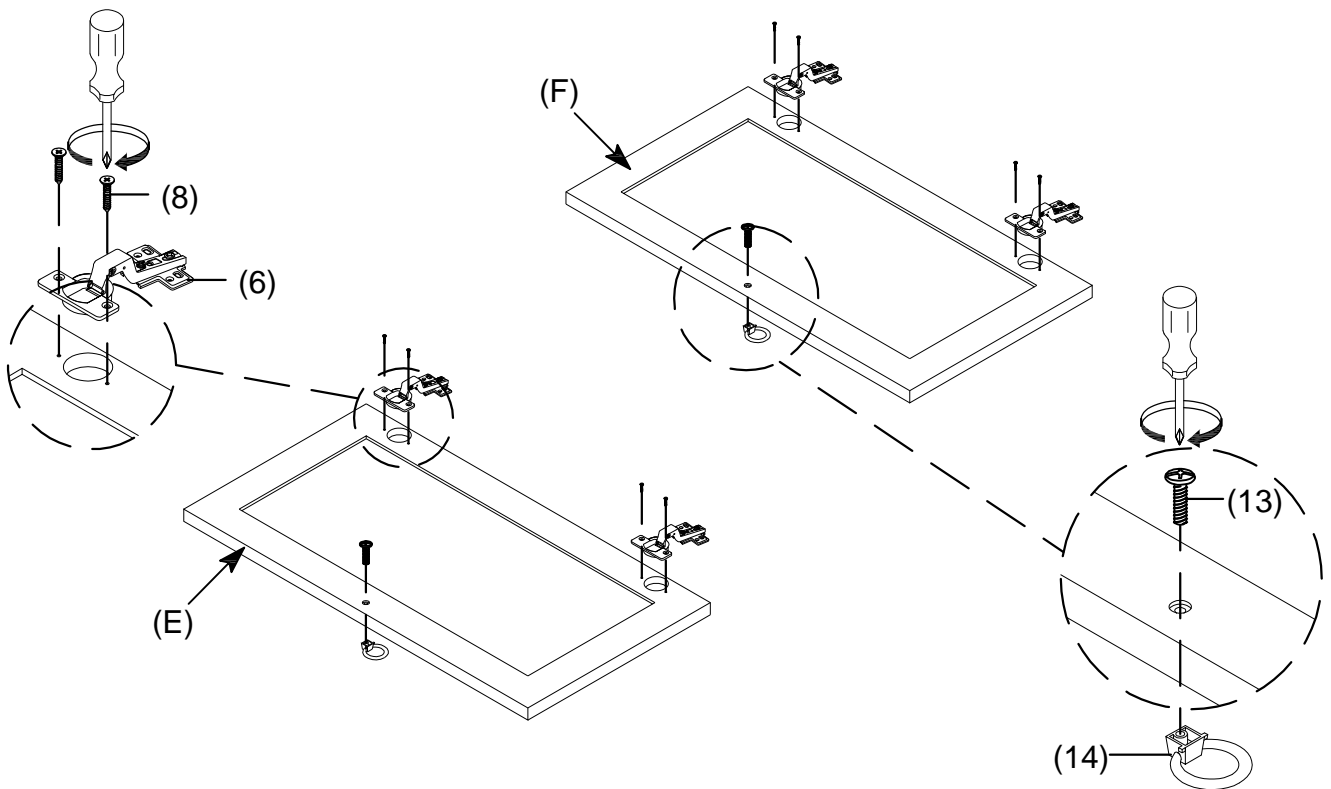

9		Bolt 1/4" x 12mm	4 pcs	11		Allen Key 4mm	1 pc
---	---	------------------	-------	----	---	---------------	------

## STEP 10





6		Inset Overlay Hinges	4 pcs	13		Ø5/32"x25mm Bolt with Screw Head	2 pcs
8		M3.5x15mm Flat Head Screw	8 pcs	14		Handle	2 pcs



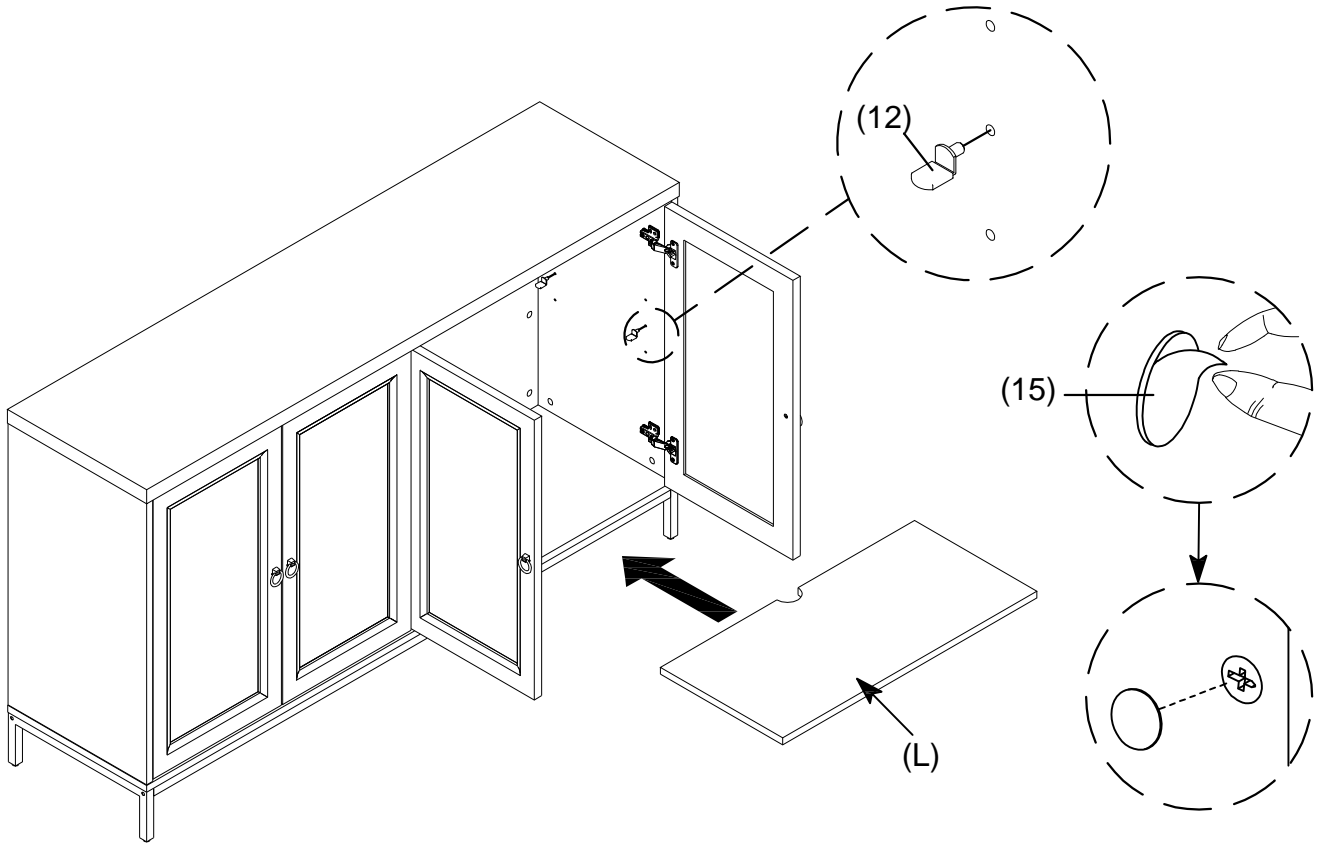

## STEP 13

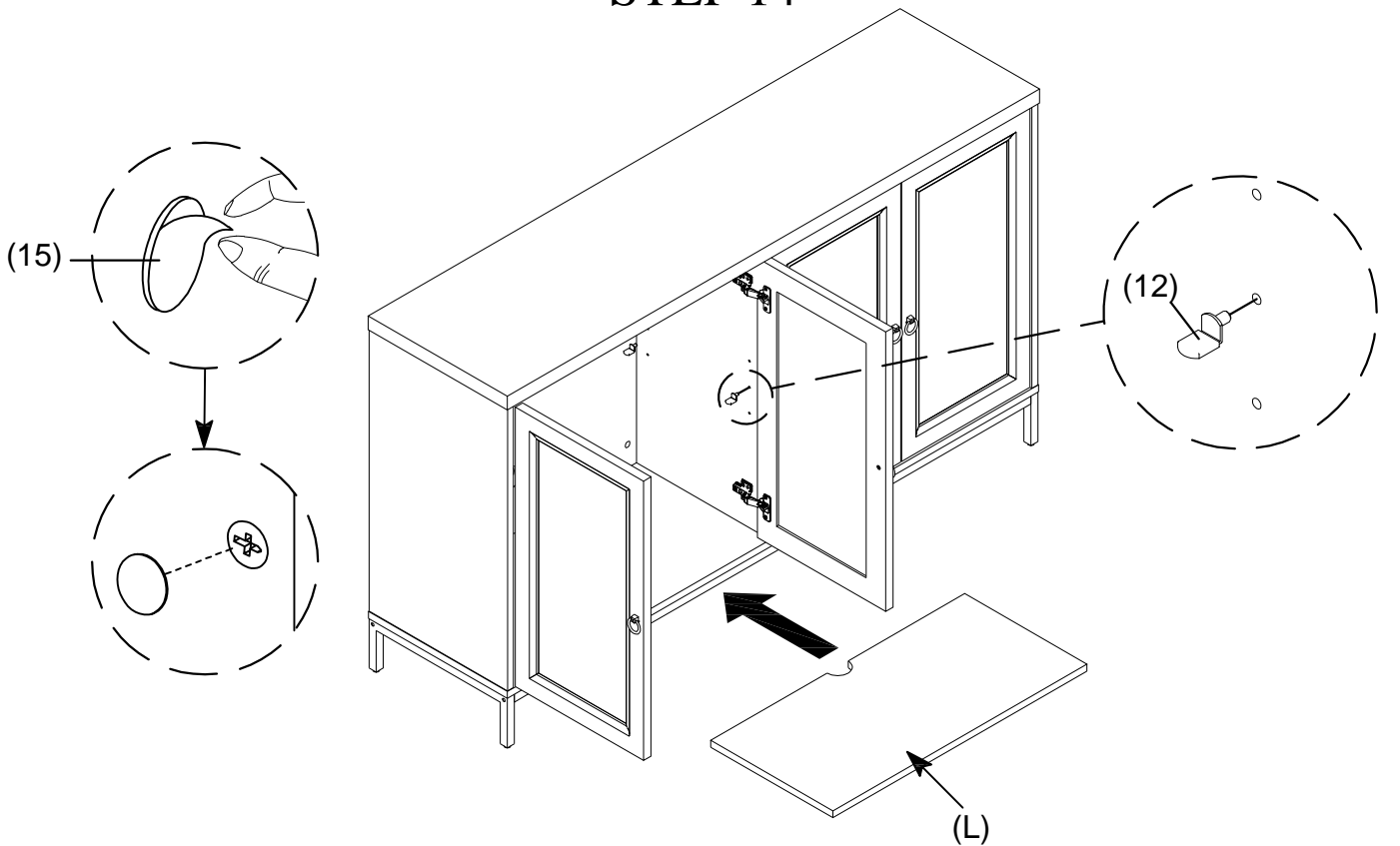

12		<b>Shelf Support</b>	4 pcs	15		<b>Sticker</b>	24 pcs
----	---	----------------------	-------	----	---	----------------	--------

## STEP 14



12		<b>Shelf Support</b>	4 pcs	15		<b>Sticker</b>	18 pcs
----	---	----------------------	-------	----	---	----------------	--------

# HINGE ADJUSTMENT

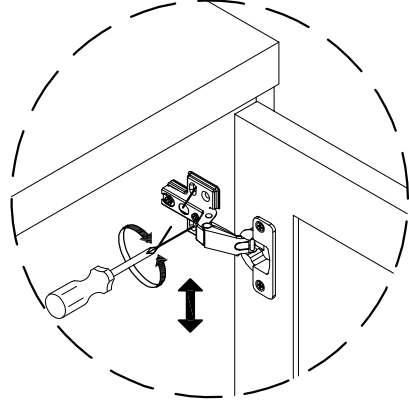
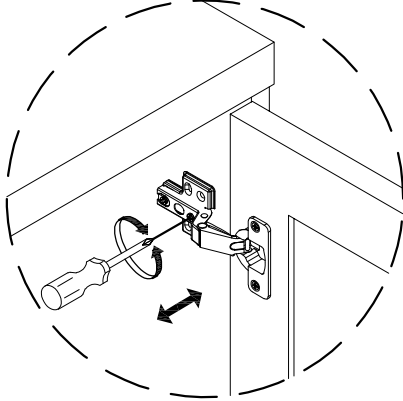
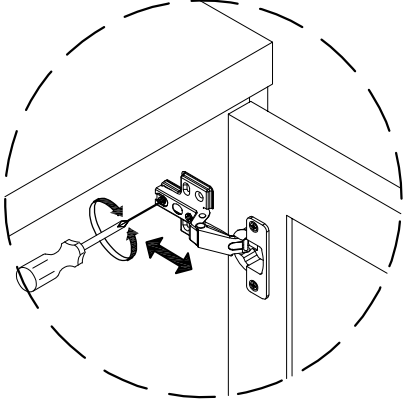

# COMPLETE

