

Mamazing

Lullapod-W Chair

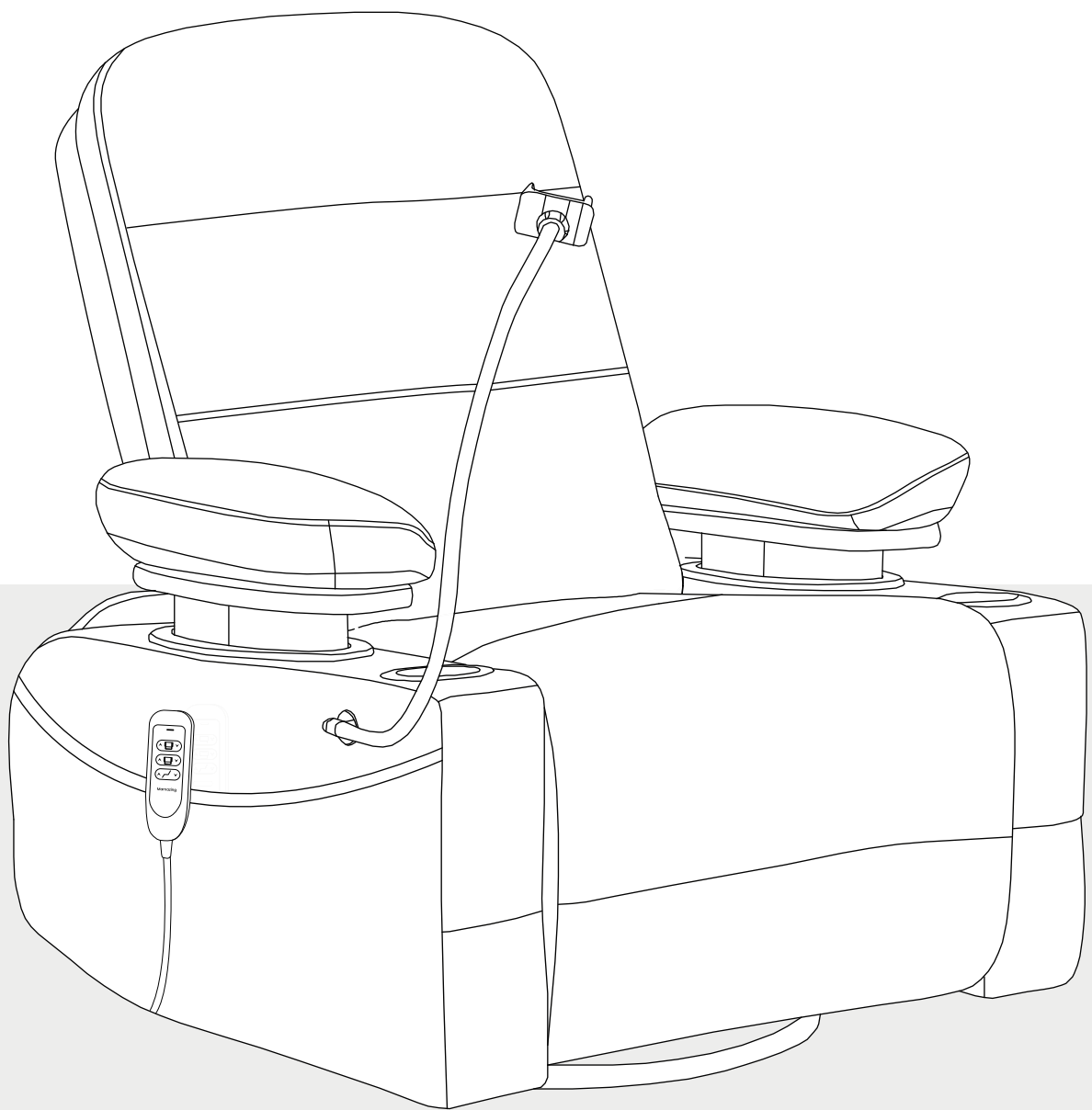

Read all instructions BEFORE assembly and USE of product.
KEEP INSTRUCTIONS FOR FUTURE USE

PARTS LIST

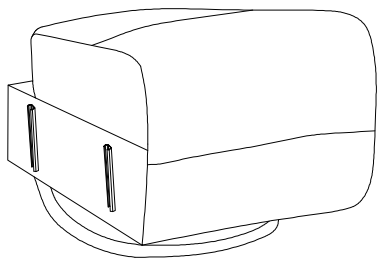

A Seat Cushion X1
Glued laminatedboard+Sponge+mitation leather+Iron frame+Electric machinery

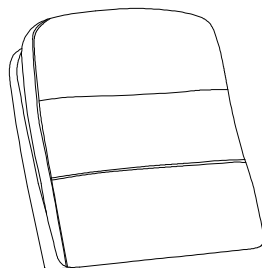

B Back Cushion X1
Sponge+Imitation leather+Polyester

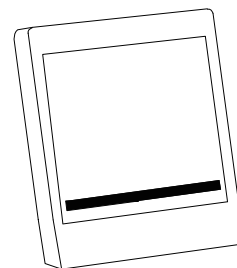

C Back Frame X1
Glued laminatedboard +Sponge+Imitation leather

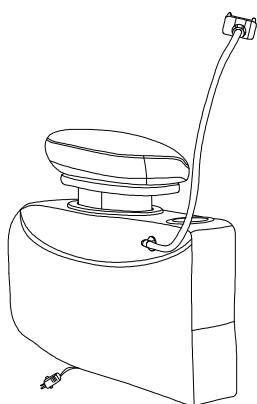

D Right Armrest X1
Glued laminatedboard+PP+Sponge+Imitation leather+Polyester

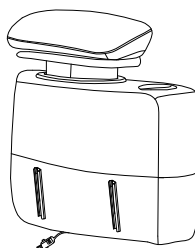

E Left Armrest X1
Glued laminatedboard+PP+Sponge+Imitation leather+Polyester



F Throw pilow X1
Imitation leather+Polyester

ACCESSORIES LIST

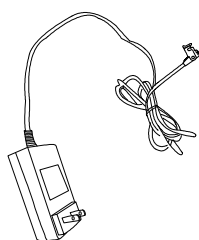

G Power Line X1

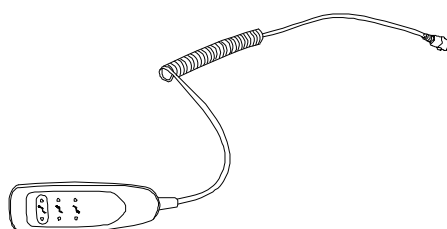

H Hand Controller X 1

HOW TO ASSEMBLE

- 1 Align the pins on the right armrest (D) and left armrest (E) with the pins on the seat cushion (A) and then connect them.

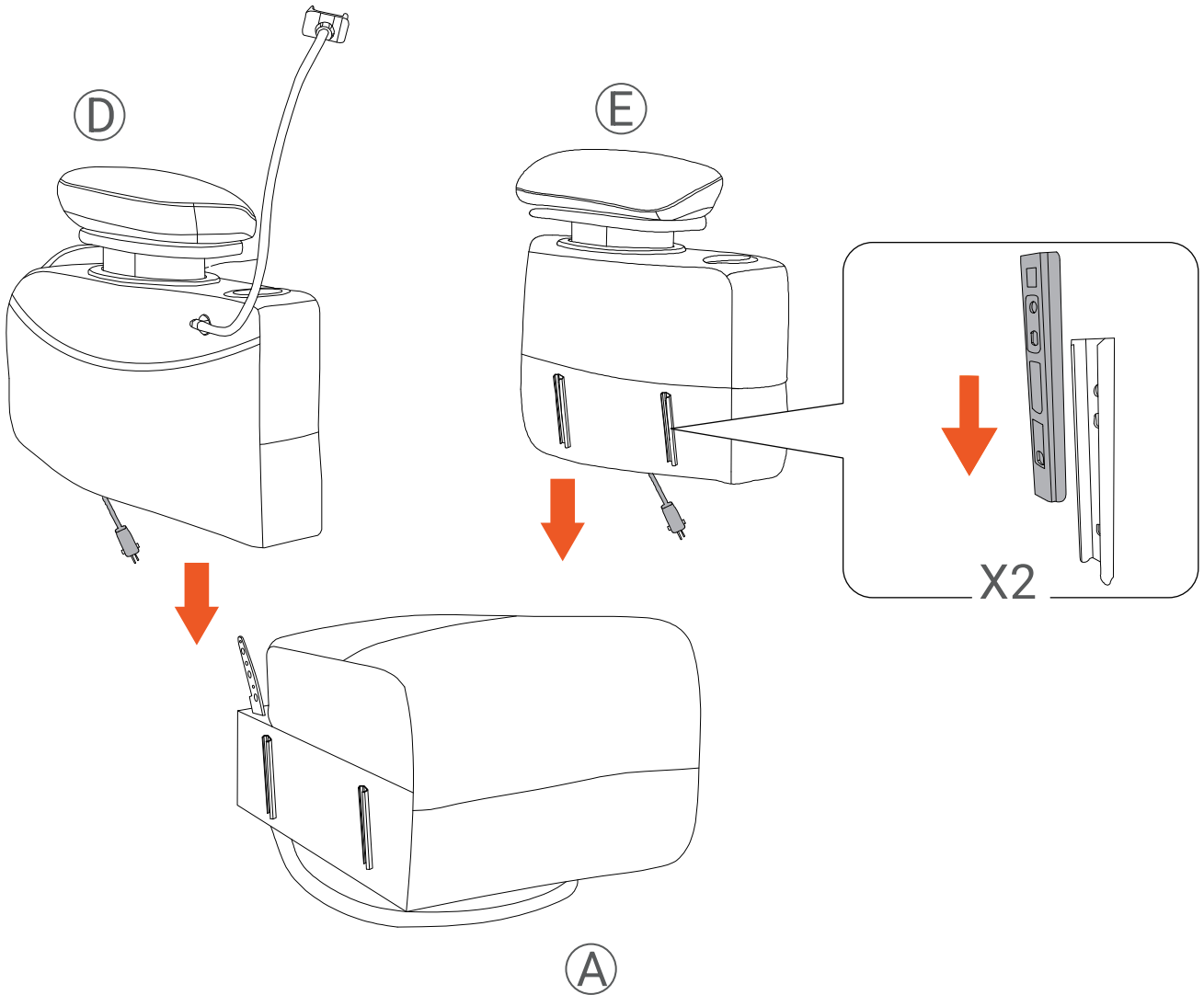

HOW TO ASSEMBLE

- 2** Align the bolt on the back of the back frame **(C)** with the slot on the seat cushion **(A)** . Then, insert the bolt to secure the back frame **(C)** to the seat cushion **(A)** .

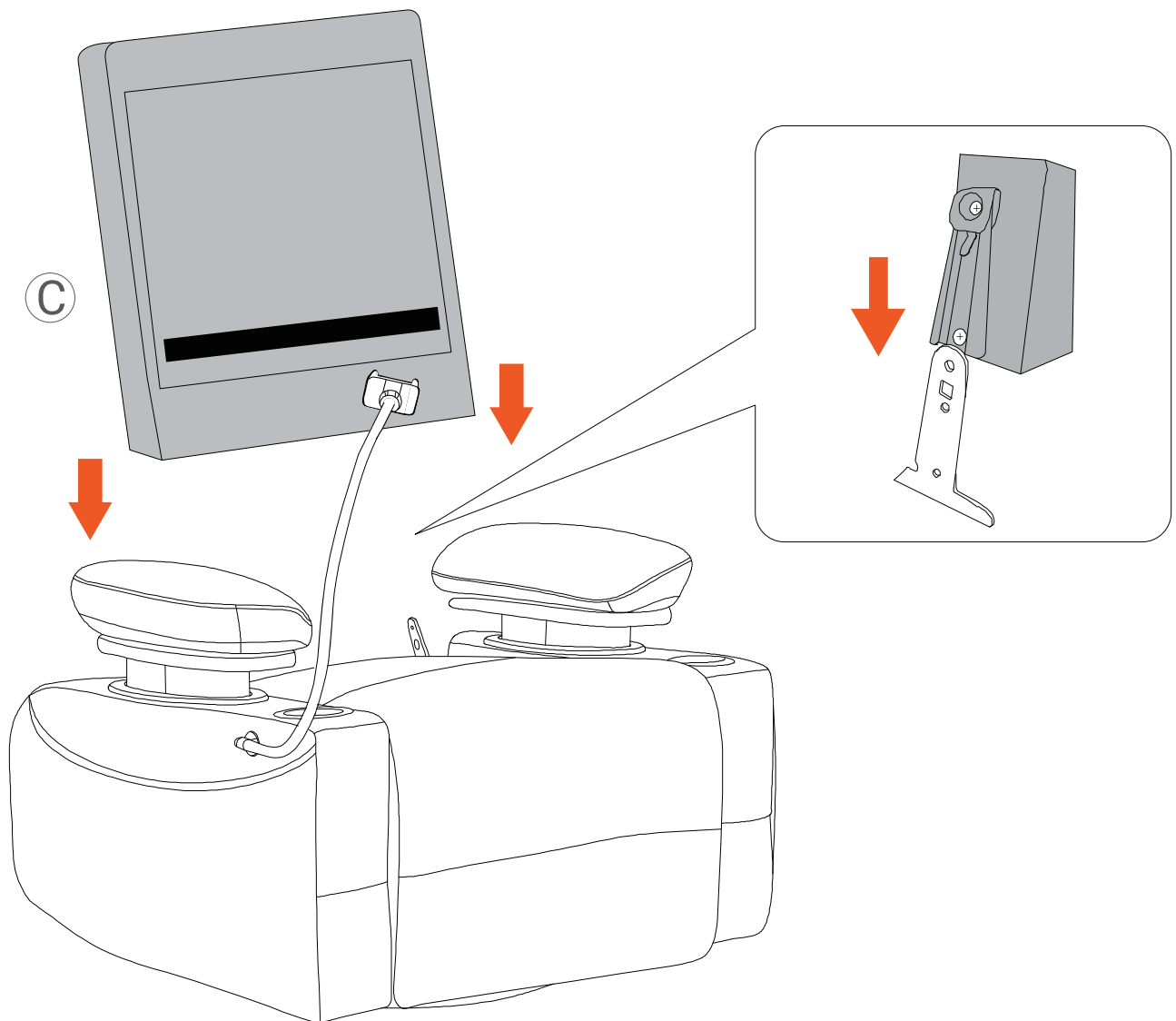

HOW TO ASSEMBLE

- 3** Use scissors to cut the compression bag along the edges, take out the back soft bag (B) and pat it.

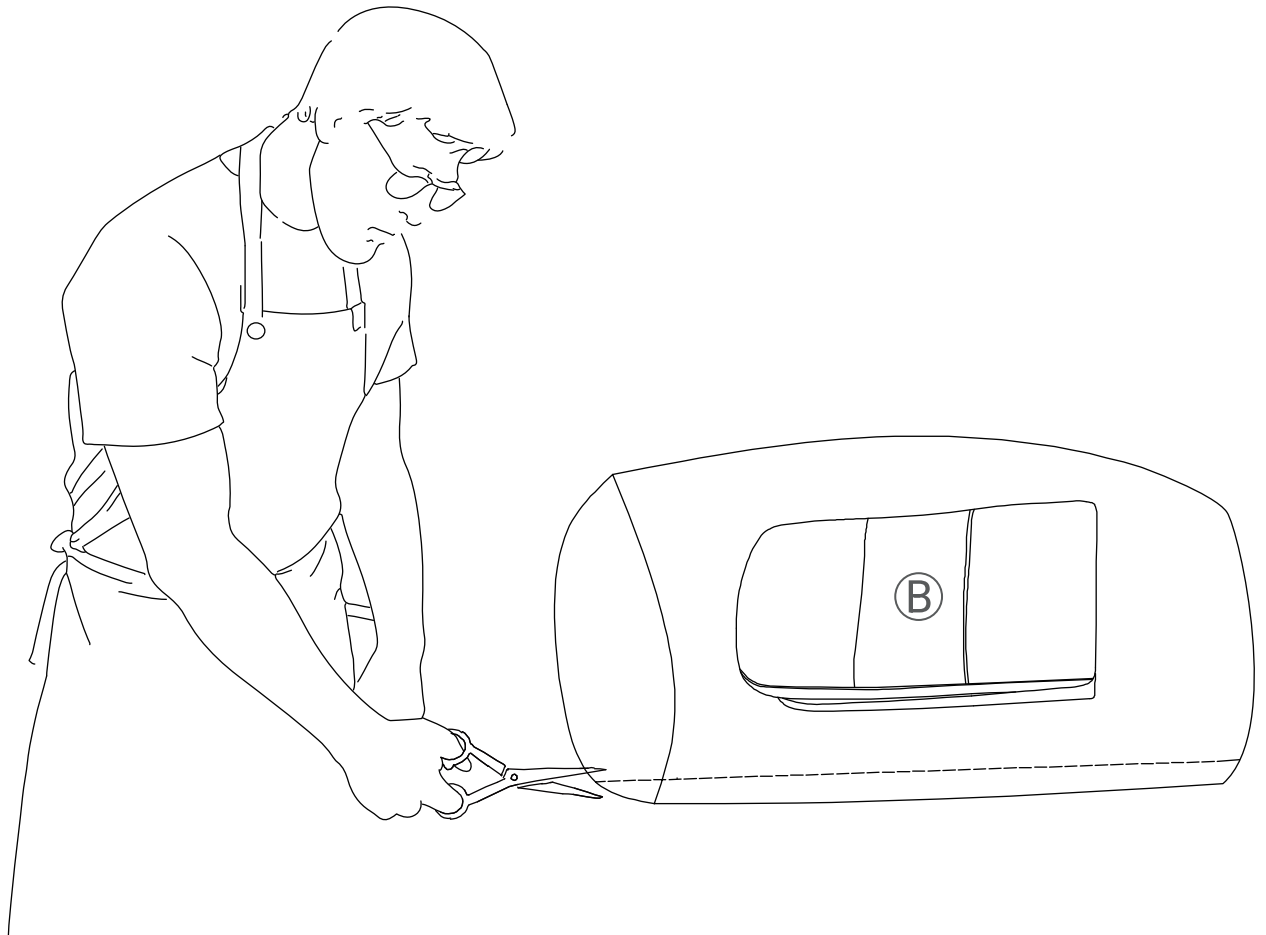

HOW TO ASSEMBLE

- 4** Align and zip the top of the back frame (C) to the top of the back cushion (B). Then attach the Velcro on the lower part of the back frame (C) to the Velcro on the back cushion (B).

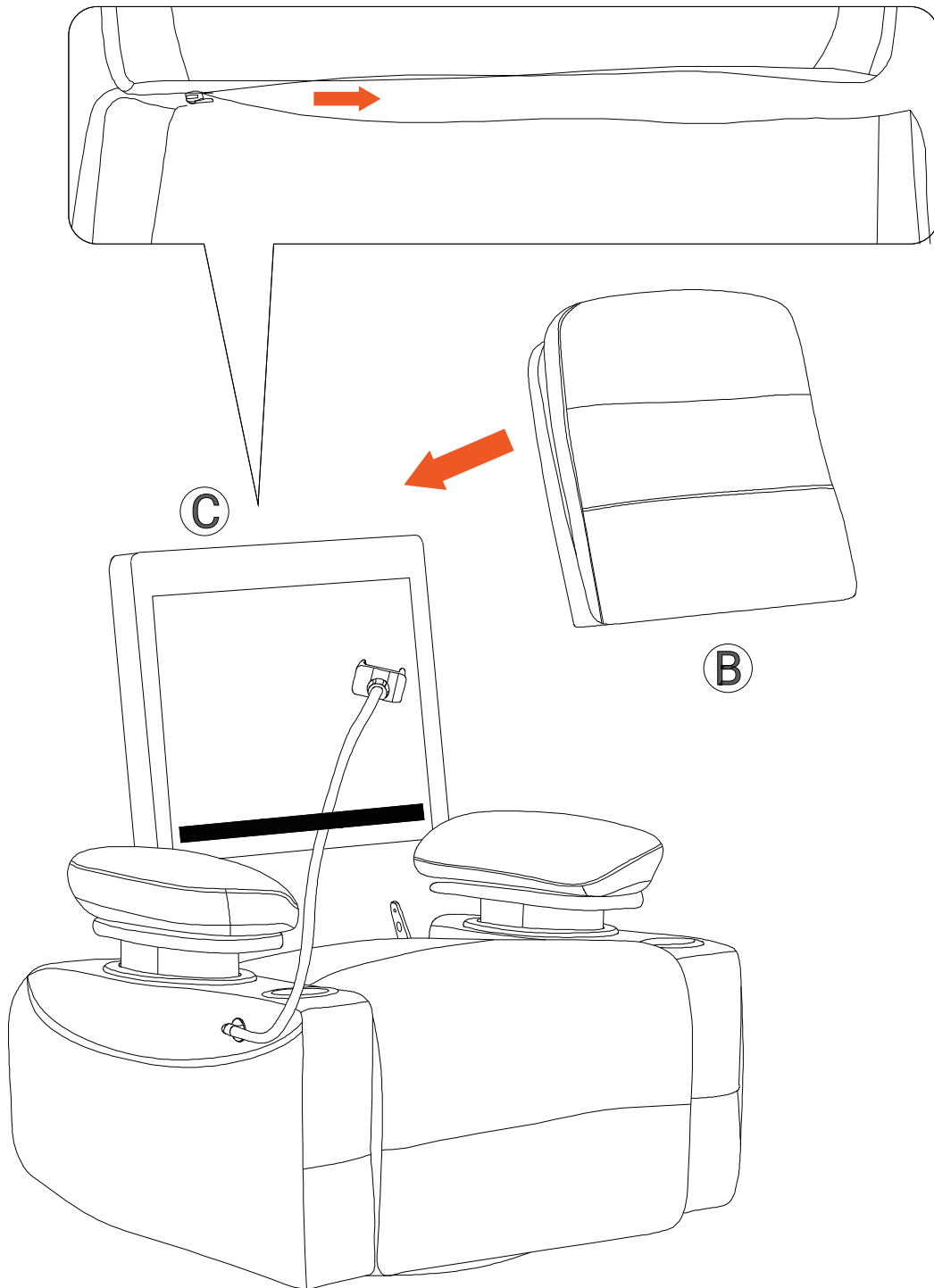

HOW TO ASSEMBLE

- 5** Connect the power cord **G** to the seat cushion **A** . Then, connect the hand con-troller **H** to the seat cushion **A** .

! **ATTENTION:**
Plug in **ONLY** with **ALL** parts connected.

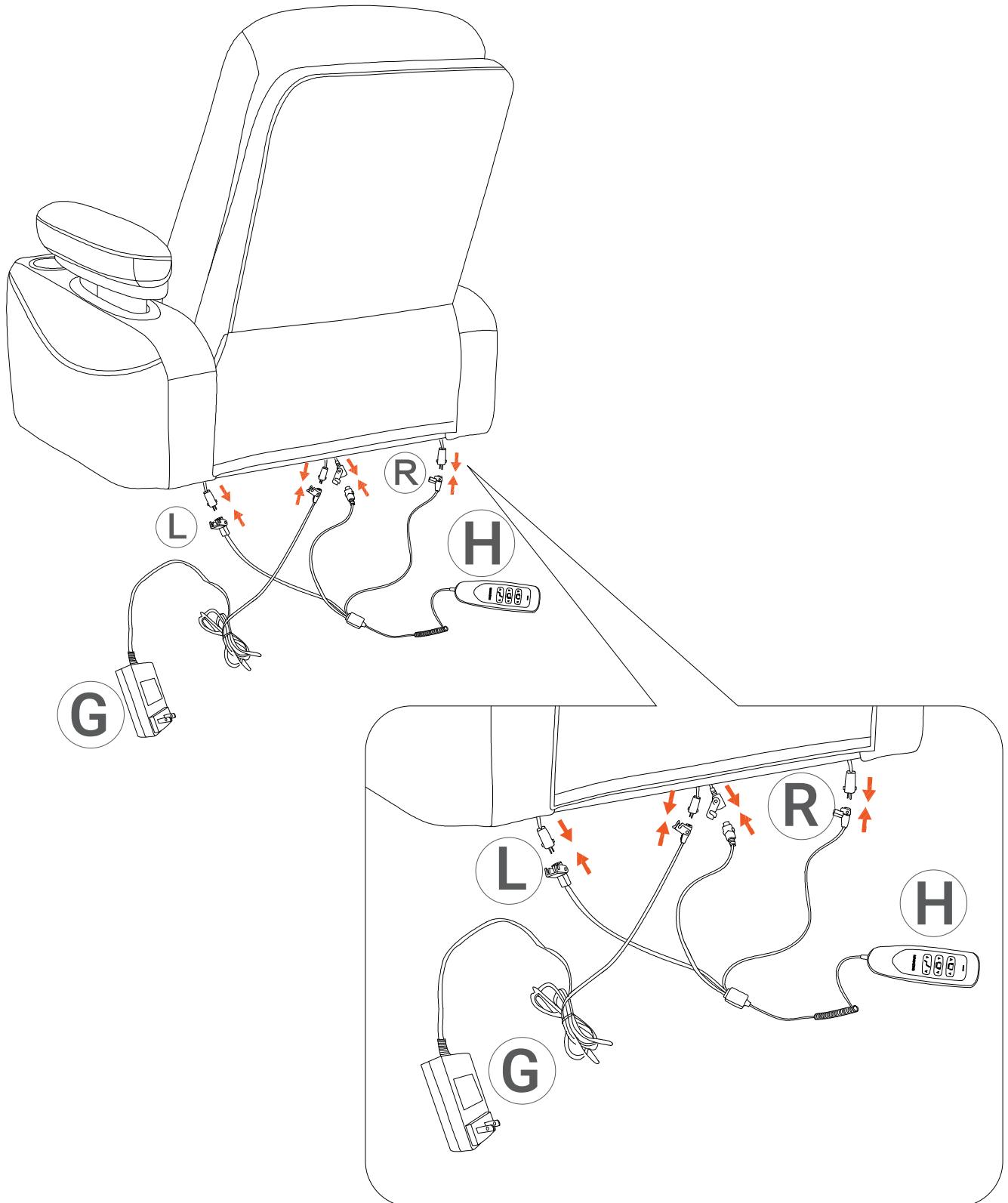

HOW TO ASSEMBLE

- 6** Place the throw pillow on the seat. Installation is complete.

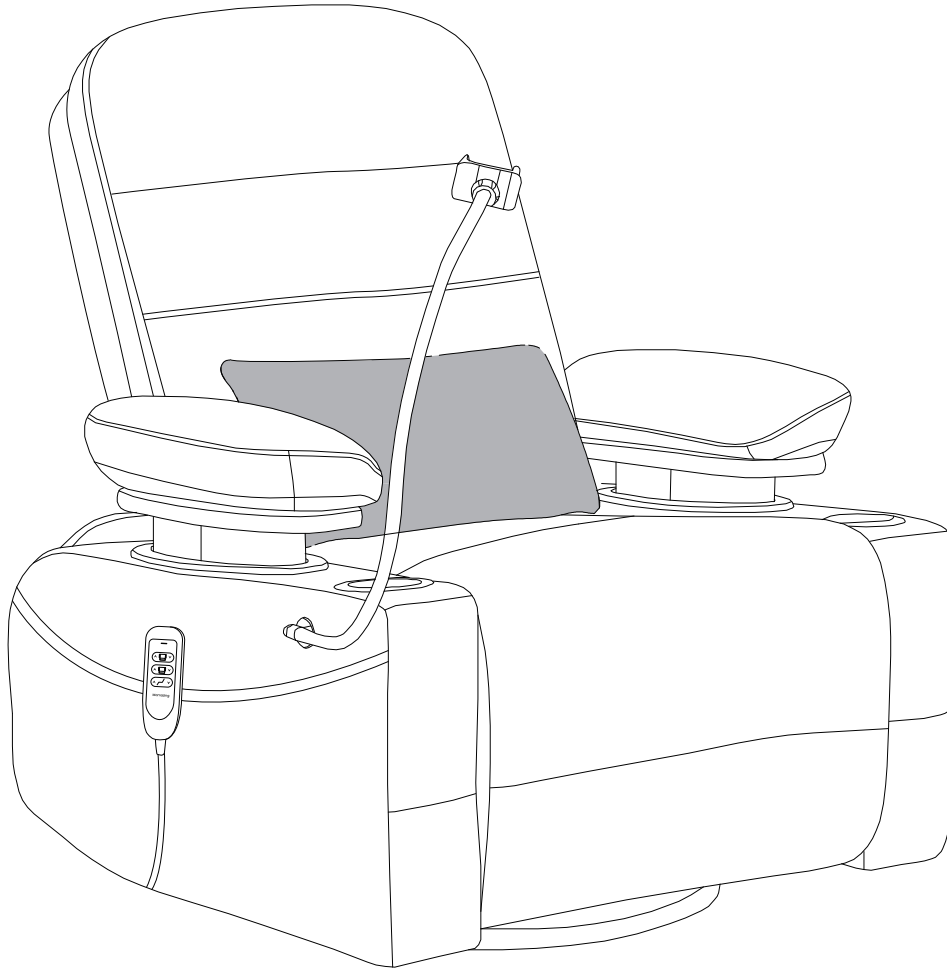



WARNING

Electrical Safety

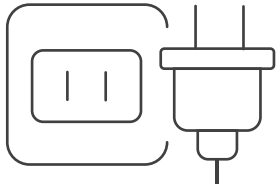

Power Outlet Requirements

Use a properly rated outlet that matches the glider's voltage requirements. Avoid sharing the outlet with high-power appliances like refrigerators or ovens.

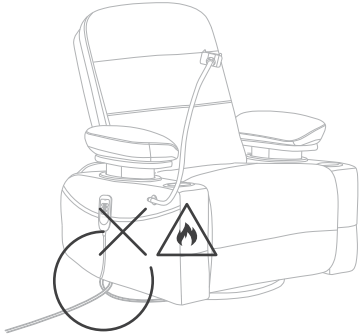

Protect the Power Cord

Ensure the power cord isn't pinched, twisted, or stretched. Always unplug the powered recliner from the electrical outlet before cleaning.

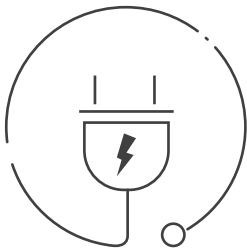

Regular Inspections

Check the power cord and plug for any damage or overheating. Stop using the glider and replace the cord if needed.

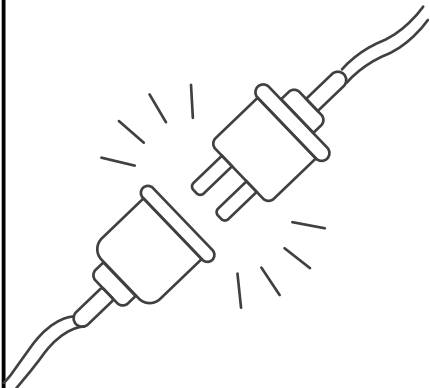

Unplug When Not in Use

Disconnect the power when the glider is not in use for extended periods to prevent standby power consumption or electrical issues.



WARNING

Environmental Considerations

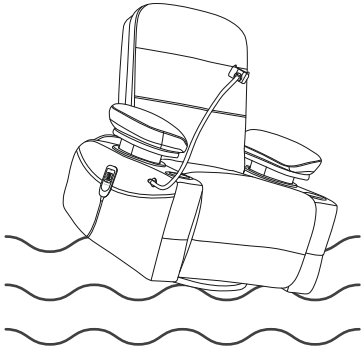

Stable Surface

Place the glider on a flat, sturdy surface to avoid wobbling or unstable rocking motion.



Dry Location Use Only

Do not use the glider in damp environments, such as bathrooms or near water sources, to avoid electrical hazards.

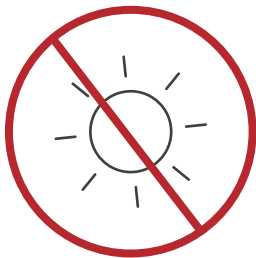

Avoid Direct Sunlight

Prolonged exposure to sunlight can cause the cushioning to fade, crack, or deform.

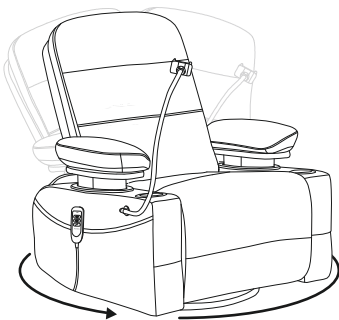

Sufficient Space

Leave at least 80 inches (203 cm) of clearance around the glider to prevent collisions when rocking or swiveling.



WARNING

Operational Guidelines

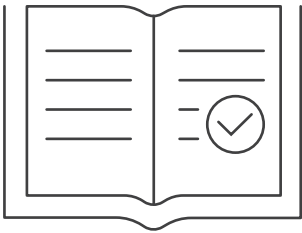

Follow Control Instructions

Familiarize yourself with the control panel and follow the instructions carefully. Keep children from playing with the controls to avoid accidental damage.



Adhere to Weight Limits

Check the glider's weight capacity (300 lbs) and avoid exceeding it to prevent damage or tipping.

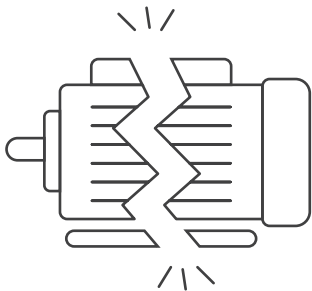

Avoid Manual Overrocking

Do not push or rock the glider forcefully, as this could strain the motor or damage its mechanism.



Use Adjustments Safely

When reclining or extending footrests, ensure your body is stable to avoid being pinched or unbalanced.



WARNING

Cleaning and Maintenance



Cushion Care

Clean the upholstery with a damp cloth and avoid harsh chemicals. If the cushion is removable, vacuum or wash it regularly.

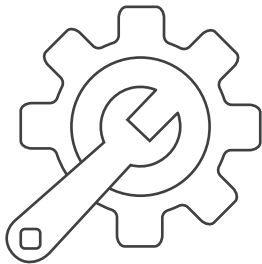

Inspect Mechanical Parts

Periodically check for loose screws or unusual noises in the motor or mechanisms. Apply lubricant if necessary.



Prevent Liquid Damage

Avoid placing drinks or liquids on the glider to prevent spills from seeping into the electrical components.

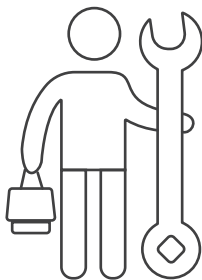

Professional Repairs

For any malfunctions, contact a qualified technician. Do not attempt repairs yourself to avoid further damage or electrical shock.



WARNING

Child and Pet Safety

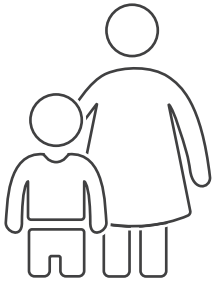

Child Safety

Supervise children around the glider. Leg rest folds down on closing so that a child could possibly be injured.



Pet Safety

Keep pets away from the glider to prevent them from chewing on cords or scratching the cushions.



TROUBLESHOOTINGS

Power & Electrical Issues

- If the glider does not power on or respond, ensure the power cord is securely connected to both the glider and the outlet. Check the cord for damage and test the outlet with another device to confirm it is working.
- If the buttons or remote control are unresponsive, check and replace the remote batteries.

Mechanical Issues

- If the glider is not reclining, rocking, or extending its footrest properly, check that all locking mechanisms are securely engaged and the components are correctly aligned.
- Inspect the moving parts for debris or obstructions, and ensure all joints and levers are operating smoothly.

Noise Issues

- Unusual noises may result from misaligned components or lack of lubrication. Ensure all clips are secure and parts aligned.
- For motor noises, record a video and contact us. Do not attempt to disassemble the internal motor components yourself.

Stability & Appearance Issues

- If the glider feels wobbly or unstable, make sure it is on a flat, level surface and that all joints, legs, and clips are securely assembled.
- For fabric or cushion issues like fading or scratches, avoid direct sunlight and clean with a soft, damp cloth and mild cleaner.



TROUBLESHOOTINGS



NOTE:

- Mamazing's gliders are rigorously inspected and certified to meet quality and safety standards, ensuring reliable and safe use.
- If the troubleshooting steps provided do not resolve the issue, please contact our customer support team for assistance. Do not attempt to disassemble, reassemble, or replace any parts without guidance from Mamazing, as this may void the glider's limited warranty.
- To help Mamazing evaluate the issue, please provide photos or videos of the problem. These materials will serve as valuable references for identifying the cause.
- Please retain the original packaging until the glider is confirmed to be functioning properly. If a return or replacement is necessary, the defective item should be returned in its original packaging or as instructed by the Mamazing authorized sellers.



CONTACT:

[E-MAIL] SERVICE@MAMAZING.COM

[WEBSITE] WWW.MAMAZING.COM

ONE YEAR LIMITED WARRANTY

Interfocus Inc. warrants that its Glider products, purchased directly from **authorized sellers**, will be free from defects in material or workmanship **for one (1) year** from the original date of purchase by the original purchaser. If an inspection within the warranty period confirms that the product is defective due to materials or workmanship, we will, at our discretion, **repair** or **replace** the product with a similar model.

This warranty is limited to the terms specified herein and does not cover defects or damage resulting from **improper installation, misuse, abuse, normal wear and tear, or unauthorized modifications**.

This warranty applies only to new Glider units with original packaging and ownership, and is non-transferable. It does not cover used, second-hand, or demo models. The warranty does not apply to damage or defects resulting from improper installation or assembly, normal wear and tear, misuse, abuse, negligence, or alterations to the product's finish, design, or hardware.

Please retain your **receipt or proof of purchase** to process any warranty claims.

Note:

The rights provided under this warranty may vary by state. Some states do not allow the exclusion or limitation of incidental or consequential damages, and some states do not allow limitations on how long an implied warranty lasts. Therefore, the above limitations or exclusions may not apply to you.

