

# CHAIR

## ASSEMBLY GUIDE

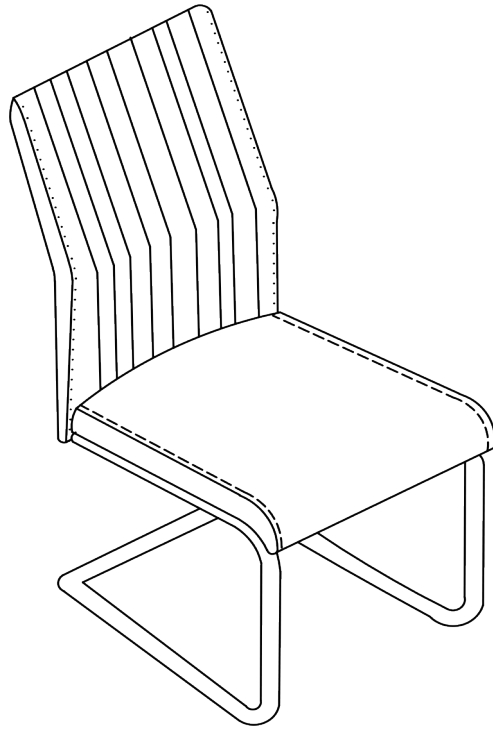

**Important - Please read these instructions fully before starting assembly**



**SAFETY AND  
CARE ADVICE**



**NO POWER TOOLS**

### **SAFETY AND CARE ADVICE**

- Check you have all the components and tools listed.
- Remove all fittings from the plastic bags and separate them into their groups.
- We do not recommend the use of power drills/drivers for inserting screws, as this could damage the unit. Only use hand screwdrivers and Allen keys.
- Keep children and animals away from the work area, small parts could cause choking if swallowed.
- Make sure you have enough space to layout the parts before starting.
- Assemble the item as close to its final position (in the same room) as possible.
- Do not overtighten the nuts to avoid causing damage to the threads.
- Only clean using a damp cloth and mild detergent, do not use bleach or abrasive cleaners.
- From time to time check that there are no loose screws on this unit
- This product should not be discarded with household waste. Take to your local authority waste disposal centre

## IMPORTANT INFORMATION



30 MINUTE  
BUILD



ONE  
PERSON



MAXIMUM  
CAPACITY  
150Kg

PLEASE CHECK CAREFULLY AND MAKE SURE YOU HAVE ALL FITTINGS AND TOOLS LISTED BELOW BEFORE YOU START.

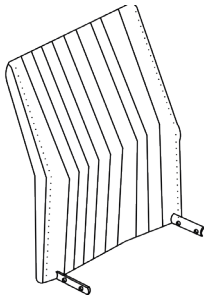



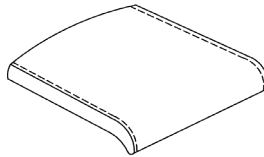

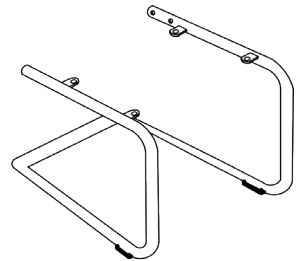

1 Back rest x 1



3 Seat pad x 1

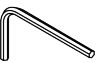

2 Leg frame x 1

<p><b>A</b></p>  <p>M8x20mm Allen Screw X4</p>	<p><b>B</b></p>  <p>M8x22mm Metal Washer X4</p>	<p><b>C</b></p>  <p>M6x20mm Allen Screw X4</p>	<p><b>D</b></p>  <p>M6x16mm Metal Washer X4</p>
<p><b>E</b></p>  <p>M6 mm Allen Key X1</p>	<p><b>F</b></p>  <p>M4 mm Allen Key X1</p>	<p><b>G</b></p>  <p>M8x12mm Spring Washer X4</p>	<p><b>H</b></p>  <p>M6x10mm Spring Washer X4</p>

**NOTE:** The quantities above are the correct amount to complete the assembly. In some cases more fittings may be supplied than are required.

## STEP 1

Place the leg frame [2] on the floor  
Insert backrest [1] into the leg frame [2]  
Using fixings (A), (B) & (G) tighten the  
backrest onto the legs.

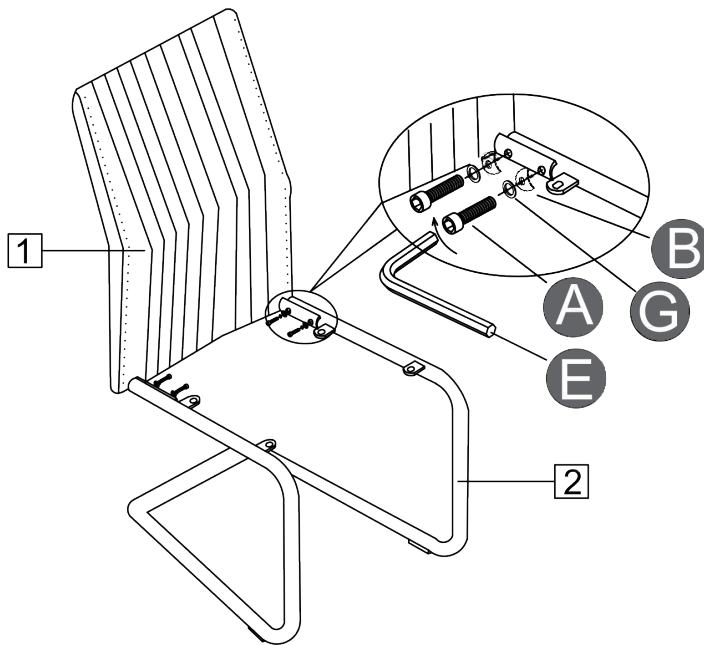

## FULL ASSEMBLY INSTRUCTIONS

### STEP 2

#### Attaching Seat Pad

Place seat pad [3] upside down onto a clear flat surface.

Carefully align the chair frame onto the seat pad [3] and secure using fixings (C), (D) & (H).

Repeat assembly on all chairs.

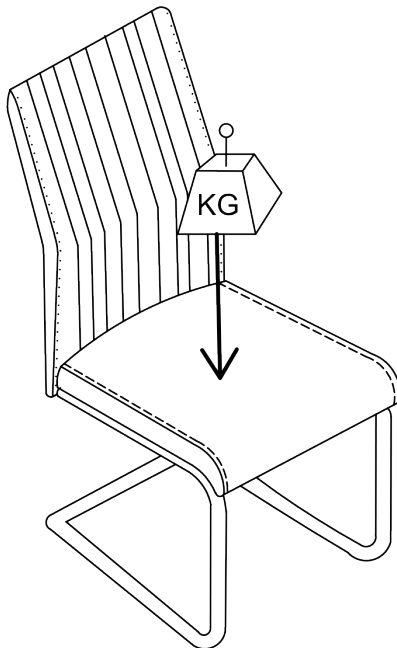
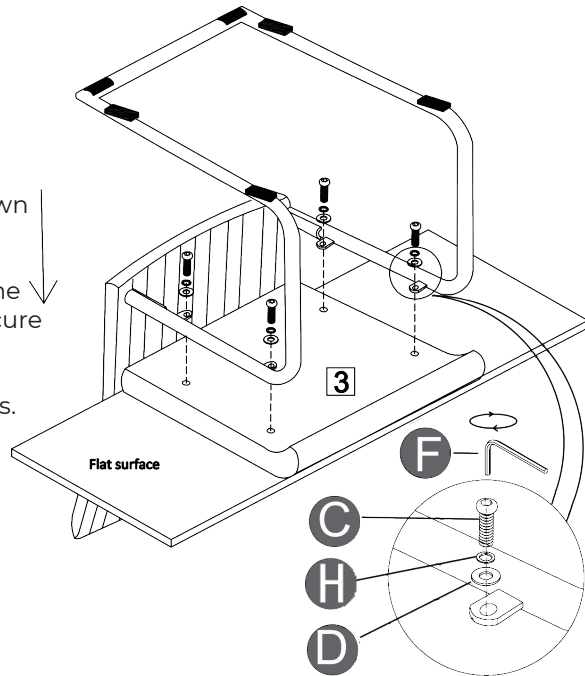

### STEP 3

**ATTENTION:** While sitting on the chair, fully tighten all the fixings to complete assembly. Your chair is now ready to use.



## OUR 1 YEAR GUARANTEE

our products come with a 1 year guarantee to give you peace of mind shopping



## WHAT THE GUARANTEE COVERS

---



**PRE-INSERTED FIXINGS**  
e.g. lose metal threads



**FAULTY JOINTS**  
e.g. legs bending



**EXTERNAL FIXING FAULTS**  
e.g. metal discs removing  
from table top



**STRUCTURAL INTEGRITY**  
e.g. the frame of the  
product