

Rectangle Dining Table Top Rectangle Dining Table Base 70" x 42" x 30"

Your furniture purchase is an investment. Here are a few tips to maximize the lifetime of your furniture with a minimal amount of effort. Properly caring for your furniture can help ensure that it looks great year after year.

Wood Furniture Maintenance:

- Always dust, wipe, and clean with the grain of the wood.
- Dust with a soft cloth. Dust will scratch the furniture surface if not removed properly.
- If a polished surface becomes foggy, rub it with a cloth dipped in a solution of one tablespoon vinegar to one quart of water. Rub softly with the grain until the surface is completely dry.
- Soap and water are not advisable for wood surfaces. Water can penetrate the finish and raise the grain on wood, causing damage.
- Remember to change dusting cloths frequently as dirty cloths may scratch your furniture's surface.

The Enemies of Wood:

- Moisture is wood's worst enemy. Liquid spills should be gently wiped up immediately. Coasters should be used under all beverages.
- Do not allow rubber or vinyl materials to lie on the furniture. Chemicals in rubber may leave a stain. Put a strip of felt or leather under accessories that have rubber or vinyl.
- Heat creates a chemical change in the furniture's finish, which result in a white spot. Use protective pads under hot dishes, appliances, etc.
- Sunlight's ultraviolet rays can damage the finish of furniture. Do not place furniture directly against a heater or radiator and do not place in the path of hot streams of air from central heating. This will cause extreme localized drying of the wood.

Marble Top Maintenance:

The surface of the marble on your table has been polished and sealed to create a generally non-porous surface. The stone has many natural characteristics including veining, hairline cracks, and color variations, which make up the stone's beauty.

To maintain the beauty of your marble:

- Protect surfaces from scratching, staining and etching by:
 - Keeping them free of debris or sharp objects.
 - Wiping up spills immediately
 - Avoiding contact with chemicals (particularly acid-based materials)
- Clean with PH neutral products or those especially formulated for use on stone.
- It is not recommended to use a water-based solvent for dark marble as it will remove the polish from the surface.

Caring for the Fabric on Upholstered Furniture:

- Frequent vacuuming of the entire upholstered area will prevent dust from settling into the fibers.
- Professional cleaning is always recommended for all upholstered pieces.
- Do not use cleaning products containing brightening agents.



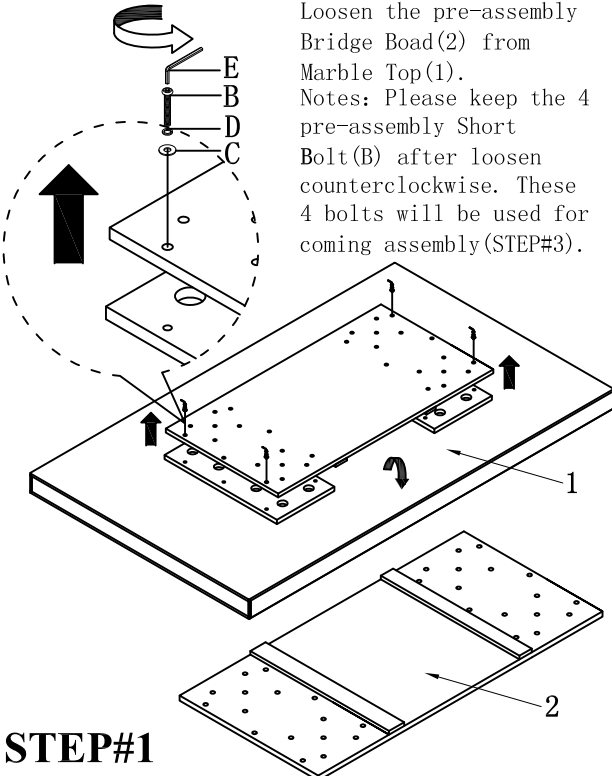
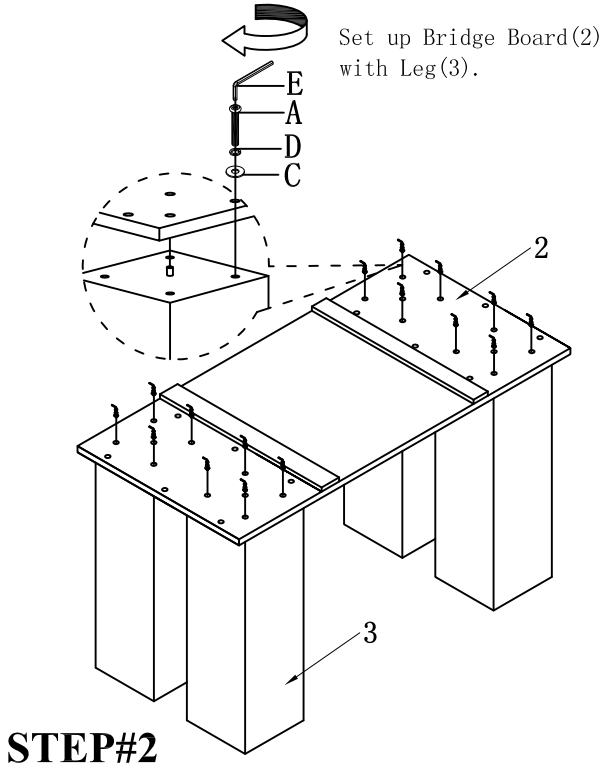
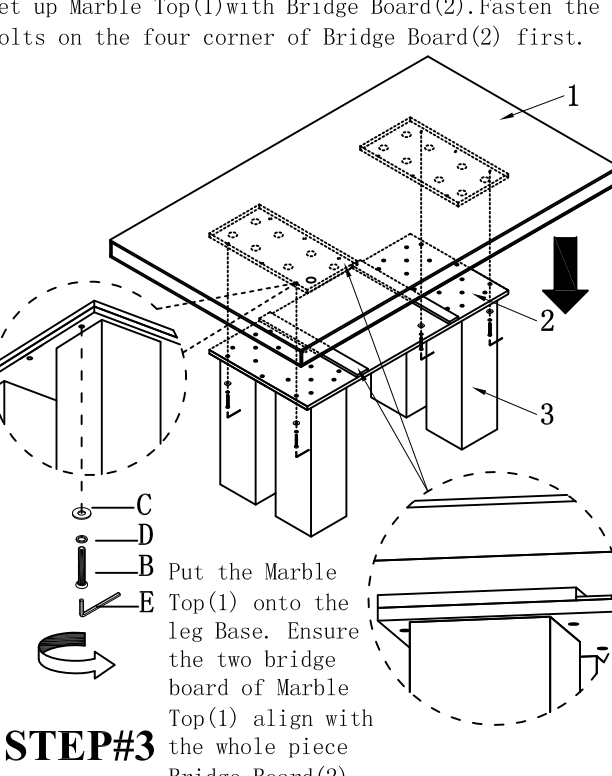
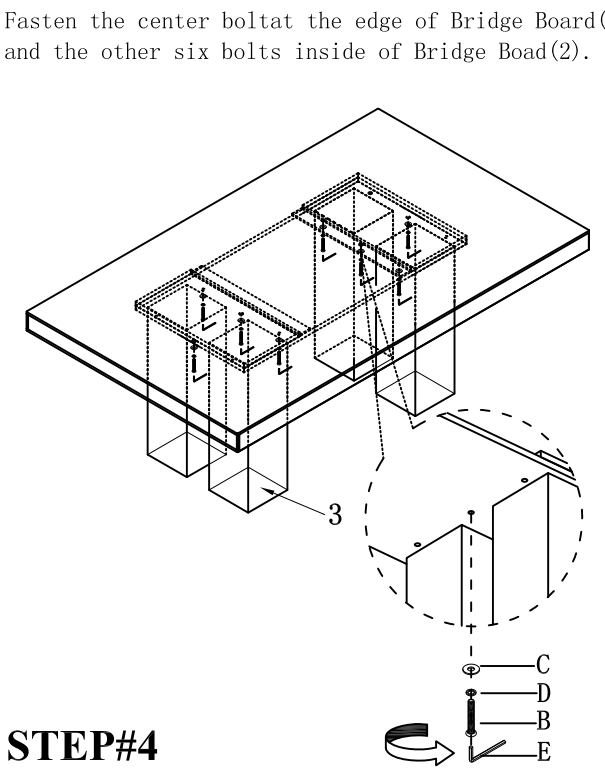

VERY IMPORTANT!!			
<p>NEVER USE GLASS CLEANERS ON FINISHED SURFACES. AMMONIA WILL CHEMICALLY ATTACK THE FINISH.</p>	<p>DO NOT WRITE DIRECTLY ON SURFACE </p> <p>PREVENT MARKING</p>	<p>DO NOT PLACE DIRECTLY IN SUNLIGHT </p> <p>PREVENT FADING</p>	<p>DO NOT USE PLACEMATS WITH RUBBER BASES </p> <p>PREVENT DISCOLORING</p>
<p>NEVER ALLOW LIQUIDS OF ANY KIND TO LINGER ON SURFACES. ABSORPTION CAUSES THE WOOD TO WARP AND THE FINISH TO DE-LAMINATE.</p>	<p>DO NOT USE COMMERCIAL POLISHES AND WAXES </p> <p>PREVENT YELLOWING</p>	<p>DO NOT PLACE HOT POTS, ETC ON SURFACE </p> <p>PREVENT DAMAGE TO FINISH!</p>	<p>REGULATE THE HUMIDITY CONDITIONS AT YOUR HOME </p> <p>PREVENT SPLITTING</p>

Assembly Instructions

 <p>Loosen the pre-assembly Bridge Board(2) from Marble Top(1). Notes: Please keep the 4 pre-assembly Short Bolt(B) after loosen counterclockwise. These 4 bolts will be used for coming assembly(STEP#3).</p> <p>STEP#1</p>	 <p>Set up Bridge Board(2) with Leg(3).</p> <p>STEP#2</p>
<p>Set up Marble Top(1) with Bridge Board(2). Fasten the 4 bolts on the four corner of Bridge Board(2) first.</p>  <p>Put the Marble Top(1) onto the leg Base. Ensure the two bridge board of Marble Top(1) align with the whole piece Bridge Board(2).</p> <p>STEP#3</p>	<p>Fasten the center bolt at the edge of Bridge Board(2) and the other six bolts inside of Bridge Board(2).</p>  <p>STEP#4</p>

Note: More than 2 people assemble required .

Hardware Pack

NO.	Description	Size	Sketch	Quantity
A	Long Bolt	Ø5/16"x2"		16PCS
B	Short Bolt	Ø5/16"x1-1/2"		12PCS
C	Flat Washer	Ø5/16" x22mm		28PCS
D	Spring Washer	Ø5/16"		28PCS
E	Allen Wrench	5mm		1PC

WARNING

- MARBLE/GRANITE IS NON-STAIN RESISTANT AGAINST FOODS AND ACIDIC OR OILY LIQUID
- IF ACIDIC OR OILY LIQUID SPILLS OVER THE MARBLE/GRANITE TABLE TOP, PLEASE IMMEDIATELY USE A DAMP SPONGES AND DETERGENT OR TOOTHPASTE TO WIPE MARBLE/GRANITE TABLE TOP UNTIL IT IS CLEAN
- COMMON OILY SUBSTANCES: COOKING OIL, OLIVE OIL
COMMON ACIDIC SUBSTANCES: KETCHUP, VINEGAR, GRAPE JUICE, LEMON JUICE
- MARBLE/GRANITE IS A NATURAL STONE PRODUCT. ANY VARIATIONS IN PATTERN, TEXTURE, AND COLOR ARE INHERENT IN THE MATERIAL AND ENHANCE THE NATURAL BEAUTY OF THE STONE.
- PLEASE DO NOT PLACE COLD OR HOT ITEMS DIRECTLY ON THE STONE

PARTS

COMPLETE HARDWARE

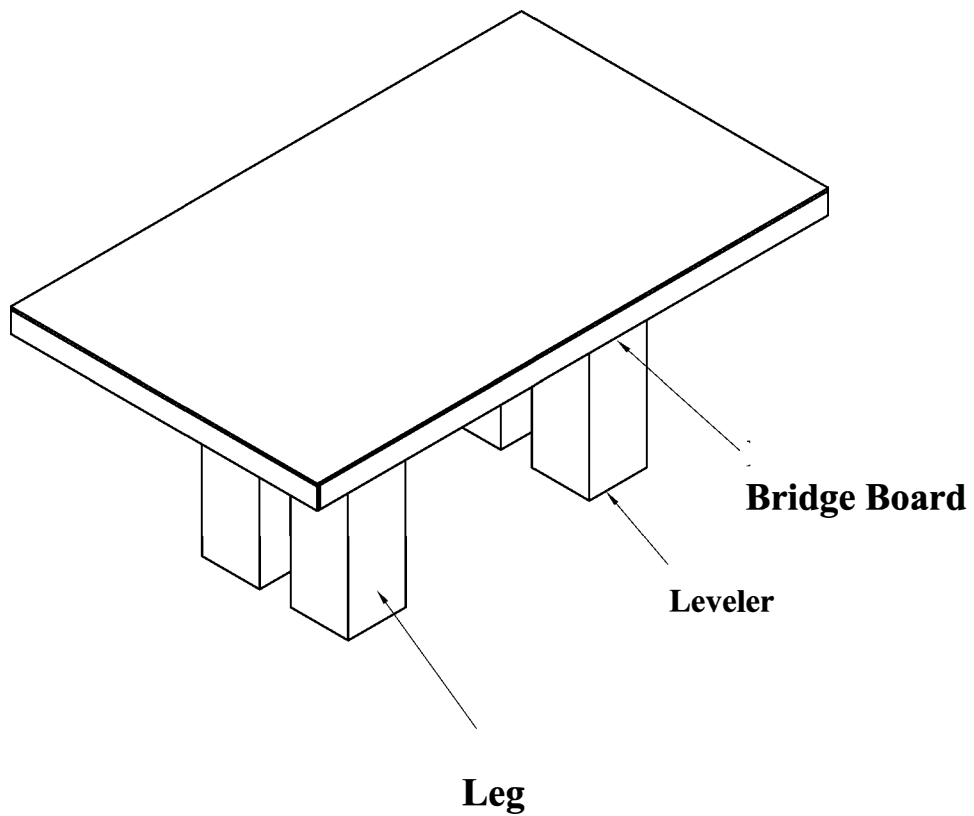

PRODUCT DETAILS	
TOP	MARBLE
LEG	BIRCH VENEER ON MDF
PRODUCT SIZE	70"x42"x30"
CARTON SIZE	:74-3/4"x46-1/2"x7-1/4" :28-3/4"x18-3/4"x19"
NET WEIGHT	:234.98LBS :69.19LBS
GROSS WEIGHT	:258.06LBS :75.68LBS
CU.FT.	:14.58' :5.93'

Velvet Dining Chair 20"x28"x41"

Your furniture purchase is an investment. Here are a few tips to maximize the lifetime of your furniture with a minimal amount of effort. Properly caring for your furniture can help ensure that it looks great year after year.

Wood Furniture Maintenance:

- Always dust, wipe, and clean with the grain of the wood.
- Dust with a soft cloth. Dust will scratch the furniture surface if not removed properly.
- If a polished surface becomes foggy, rub it with a cloth dipped in a solution of one tablespoon vinegar to one quart of water. Rub softly with the grain until the surface is completely dry.
- Soap and water are not advisable for wood surfaces. Water can penetrate the finish and raise the grain on wood, causing damage.
- Remember to change dusting cloths frequently as dirty cloths may scratch your furniture's surface.

The Enemies of Wood:

- Moisture is wood's worst enemy. Liquid spills should be gently wiped up immediately. Coasters should be used under all beverages.
- Do not allow rubber or vinyl materials to lie on the furniture. Chemicals in rubber may leave a stain. Put a strip of felt or leather under accessories that have rubber or vinyl.
- Heat creates a chemical change in the furniture's finish, which result in a white spot. Use protective pads under hot dishes, appliances, etc.
- Sunlight's ultraviolet rays can damage the finish of furniture. Do not place furniture directly against a heater or radiator and do not place in the path of hot streams of air from central heating. This will cause extreme localized drying of the wood.

Marble Top Maintenance:

The surface of the marble on your table has been polished and sealed to create a generally non-porous surface. The stone has many natural characteristics including veining, hairline cracks, and color variations, which make up the stone's beauty.

To maintain the beauty of your marble:

- Protect surfaces from scratching, staining and etching by:
 - Keeping them free of debris or sharp objects.
 - Wiping up spills immediately
 - Avoiding contact with chemicals (particularly acid-based materials)
- Clean with PH neutral products or those especially formulated for use on stone.
- It is not recommended to use a water-based solvent for dark marble as it will remove the polish from the surface.

Caring for the Fabric on Upholstered Furniture:

- Frequent vacuuming of the entire upholstered area will prevent dust from settling into the fibers.
- Professional cleaning is always recommended for all upholstered pieces.
- Do not use cleaning products containing brightening agents.

VERY IMPORTANT!!

NEVER
USE GLASS CLEANERS
ON FINISHED SURFACES.
AMMONIA WILL
CHEMICALLY ATTACK
THE FINISH.

DO NOT
WRITE
DIRECTLY
ON
SURFACE



**PREVENT
MARKING**

DO NOT
PLACE
DIRECTLY
IN
SUNLIGHT



**PREVENT
FADING**

DO NOT
USE
PLACEMATS
WITH
RUBBER
BASES



**PREVENT
DISCOLORING**

NEVER
ALLOW LIQUIDS OF ANY
KIND TO LINGER ON
SURFACES. ABSORPTION
CAUSES THE WOOD TO
WARP AND THE FINISH
TO DE-LAMINATE.

DO NOT USE
COMMERCIAL
POLISHES
AND WAXES



**PREVENT
YELLOWING**

DO NOT
PLACE HOT
POTS, ETC
ON
SURFACE



**PREVENT
DAMAGE TO
FINISH!**

REGULATE
THE
HUMIDITY
CONDITIONS
AT YOUR
HOME

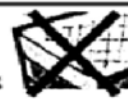



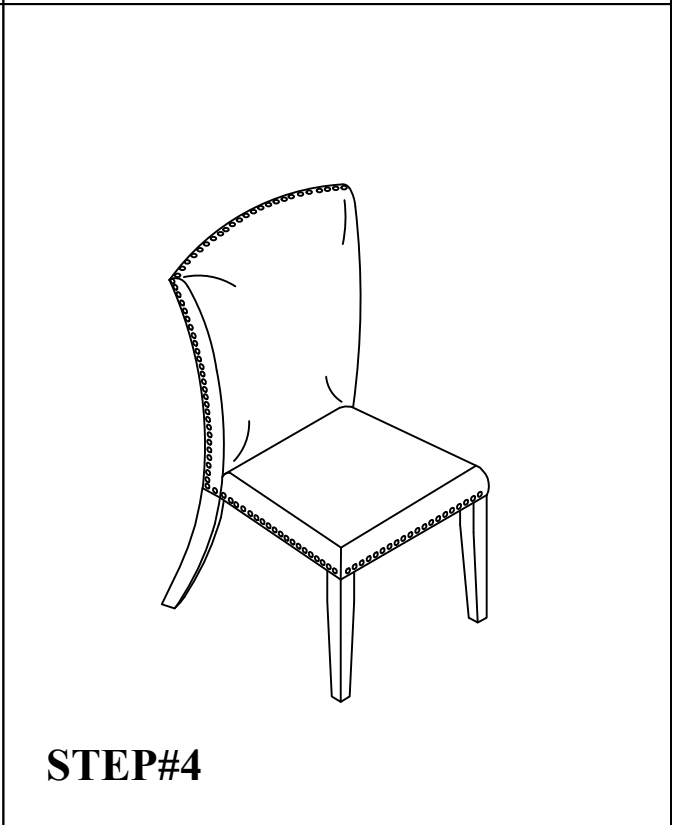
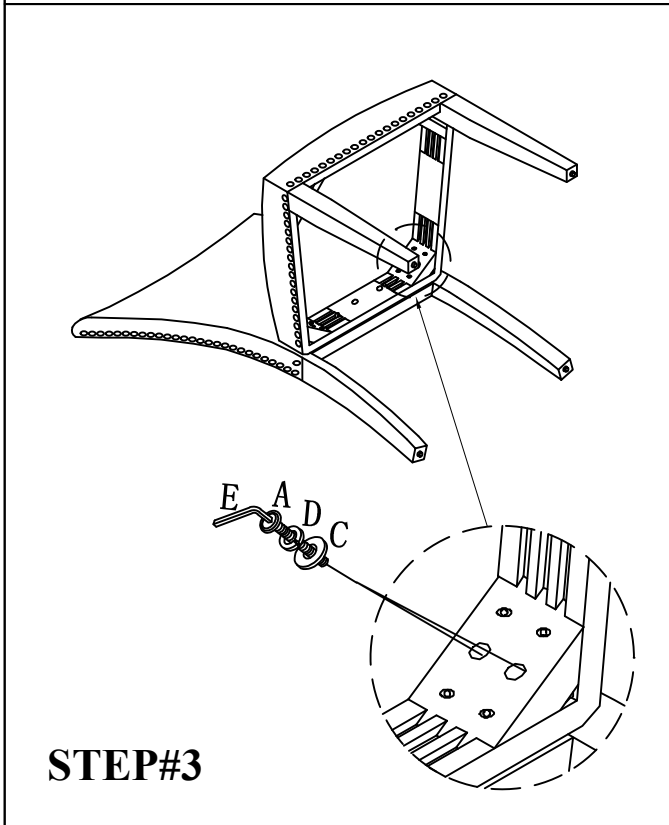
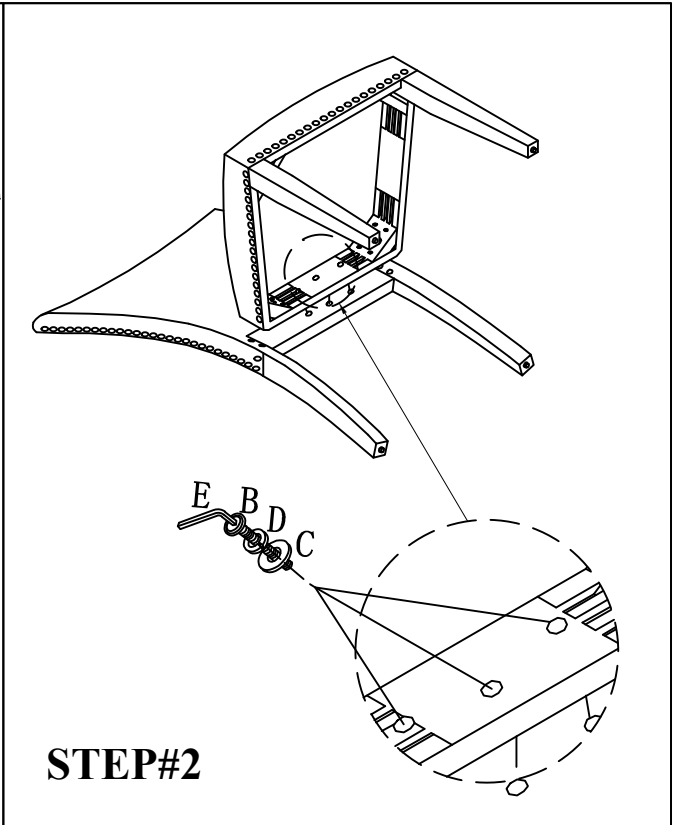
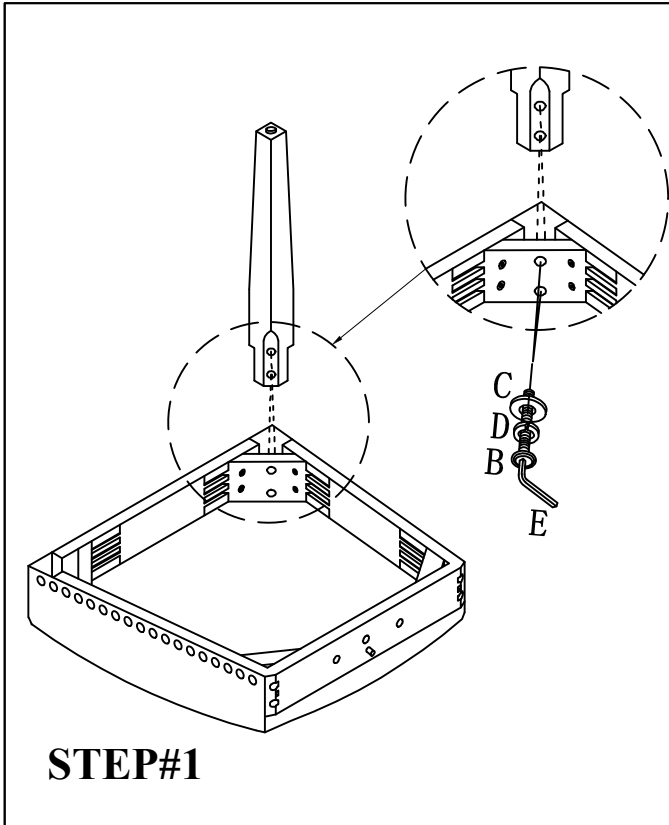

**PREVENT
SPLITTING**

Assembly Instructions

Do not fully tighten bolts & screws until the entire item is completely assembled.



Hardware Pack

A	Long Bolt	$\text{Ø}5/16'' \times 3-1/4''$		4PCS
B	Short Bolt	$\text{Ø}5/16'' \times 2''$		7PCS
C	Flat Washer	$\text{Ø}5/16'' \times 19\text{mm}$		11PCS
D	Spring Washer	$\text{Ø}5/16''$		11PCS
E	Allen Wrench	5mm		1PC

PARTS

COMPLETE HARDWARE

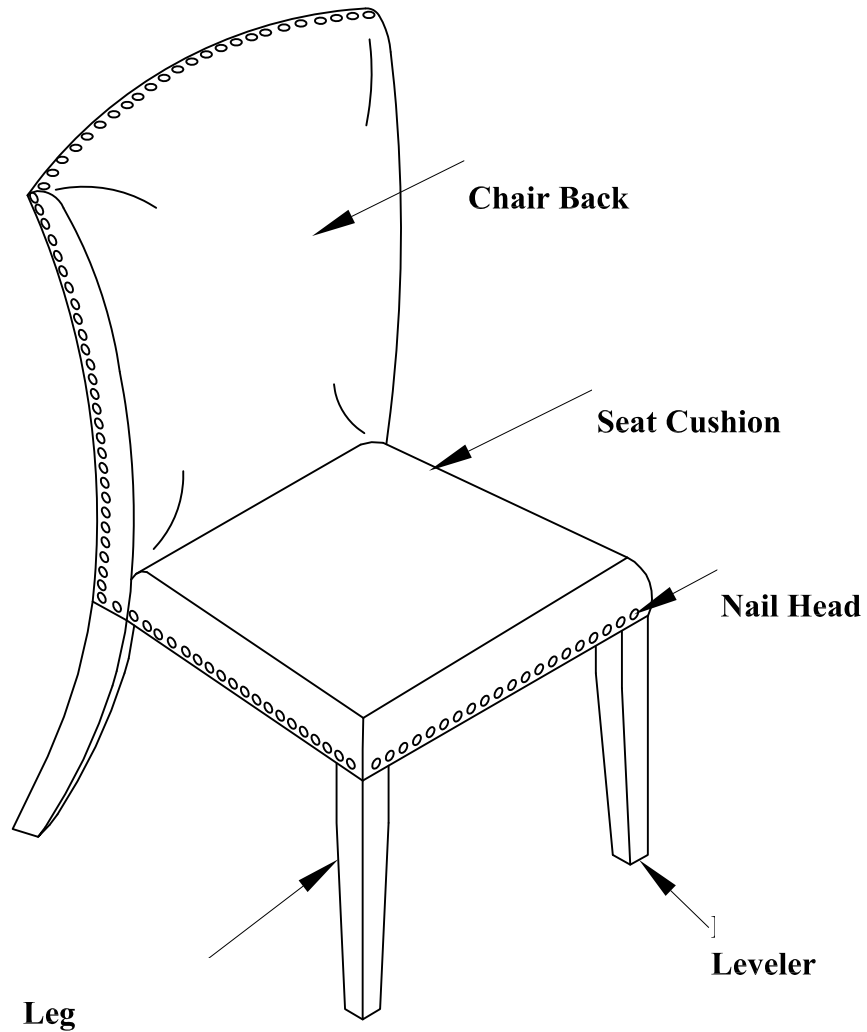

PRODUCT DETAILS	
BACK	White Vertebra Wood
SEAT BOX	White Vertebra Wood
LEG	White Vertebra Wood
COLOR OF FABRIC	Blue Velvet
PRODUCT SIZE	20"x28"x41"
CARTON SIZE	41-3/4"x13-3/4"x21"
NET WEIGHT	32.78 LBS
GROSS WEIGHT	39.34 LBS
CU.FT.	6.98'

FABRIC CONTENT: 100% Polyester
 This fabric is machine washable.
 Allow +/-3% residual shrinkage.
 Do not use cleaning products containing brightening agents.
 Do not mix fabrics of different colors.
 The fabric is suitable for drapery and upholstery.

The care icons indicate: Do not machine wash, Do not bleach, Do not iron, and Polyester (P).

Assembly Troubleshooting Guide

The most important element of correct chair assembly is to tighten the bolts as directed. Prematurely tightening the bolts can lead to numerous issues and will lengthen the assembly time. Listed below are the most common issues in chair assembly and their easy solutions.

PROBLEM: Chair is unlevel.

Cause 1:

Unlevel chairs can occur if the bolts are fully tightened before all bolts are attached. There is a variance in the alignment of this chair to allow the chair to be assembled more easily.

Solution:

Loosen each bolt in the seat box (front legs, back corner blocks and back apron) until they are finger tight. Place the chair upright on the floor. Sit in the chair for about 30 seconds. Carefully turn the chair upside down and tighten each bolt. The chair will now be level.

Cause 2:

Unlevel chairs can occur if one or more of the floor glides are missing from the bottom of the chair leg.

Solution:

Request a set of floor glides from the e-mail address below.

PROBLEM: Bolts do not fit properly.

Cause:

This issue can occur when the bolts are tightened fully before all bolts are attached. There is a variance in the alignment of the bolts to allow the chair to be assembled more easily. Tightening the bolts prematurely can cause the holes for the other bolts to become slightly misaligned, causing the remaining bolts not to fit properly.

Solution:

Make sure each bolt in the seat box (front legs, back corner blocks and back apron) is loosened until finger tight. This will allow you to realign the holes, and the bolts will not fit properly.