

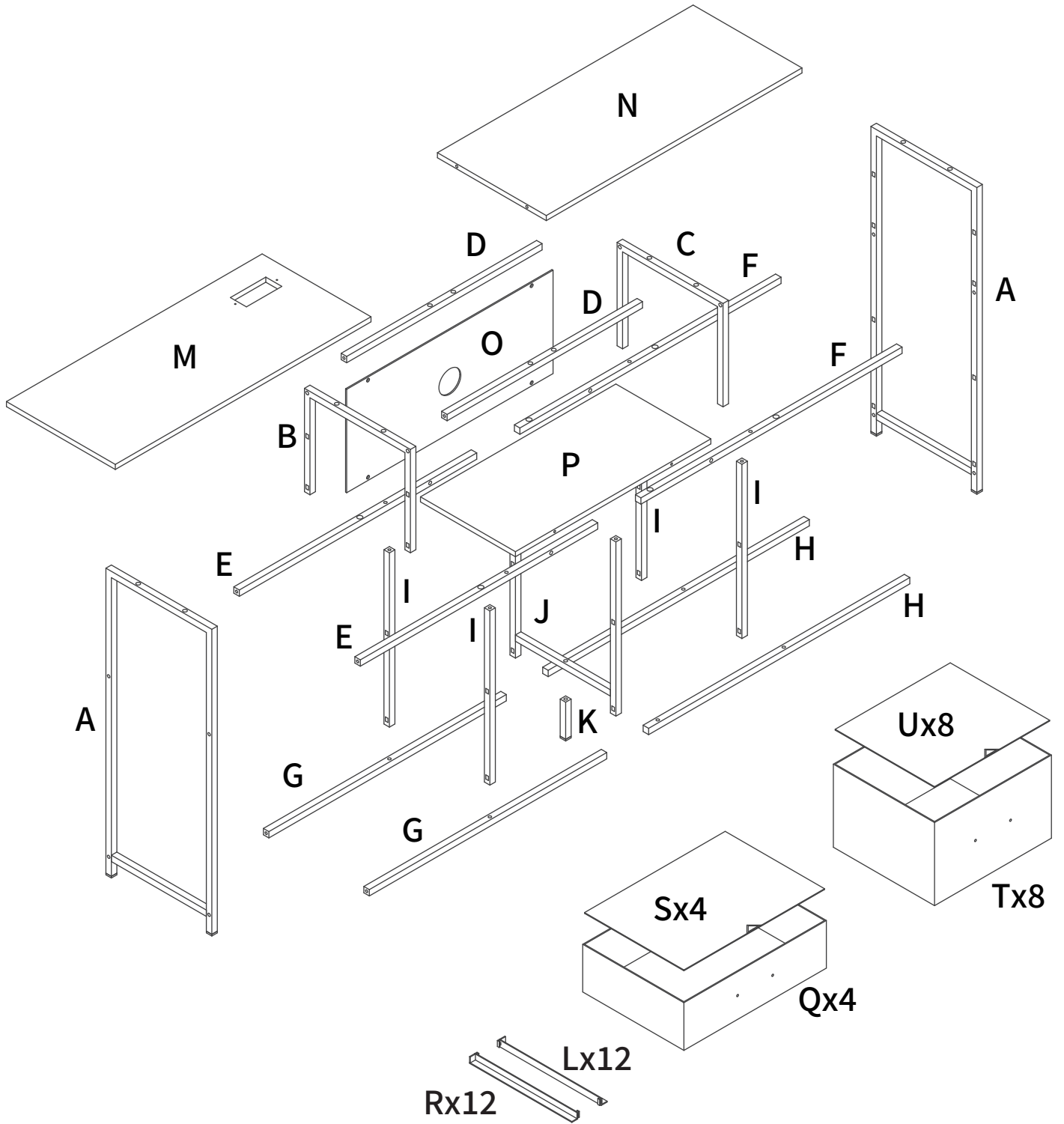





SKU:DJ504327

Disassembly Diagram

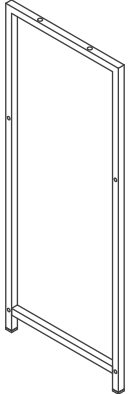
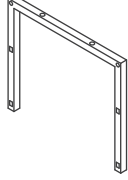
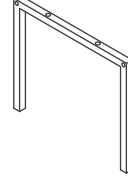
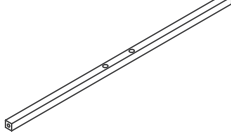
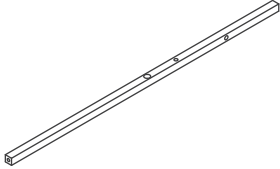
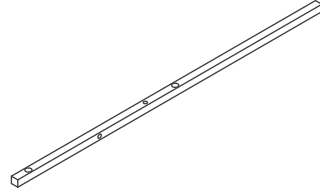
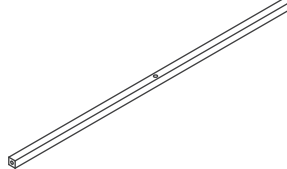
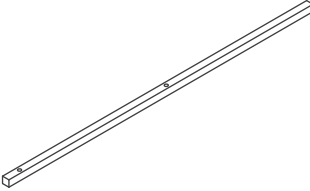

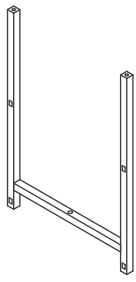

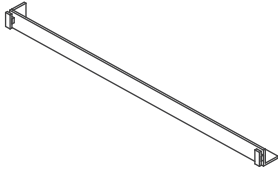
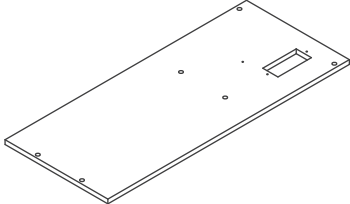
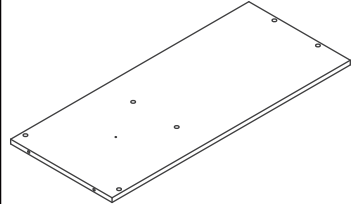
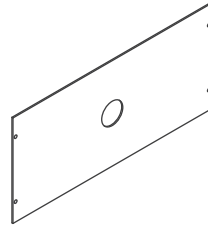
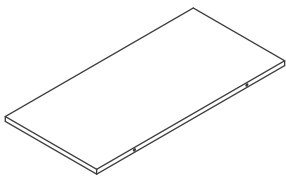

Accessories

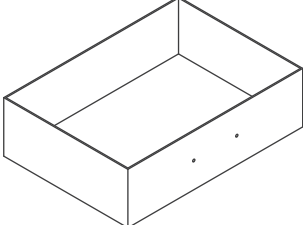
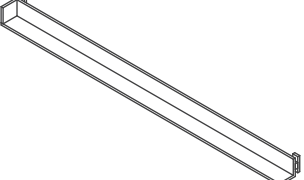
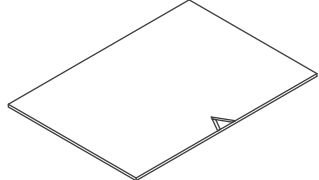
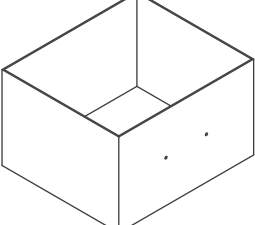
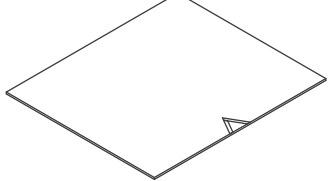
A x2 	B x1 	C x1 	D x2 
E x2 	F x2 	G x2 	H x2 
I x4 	J x1 	K x1 	L x13  1 Spare
M x1 	N x1 	O x1 	P x1 

Accessories

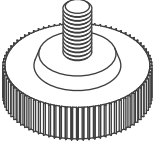

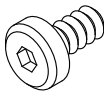
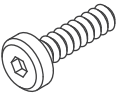
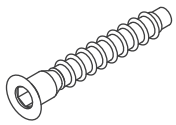
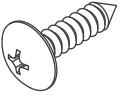
<p>Q x4</p> 	<p>R x13</p>  <p>1 Spare</p>	<p>S x4</p> 	<p>T x8</p> 
<p>U x8</p> 			

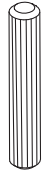
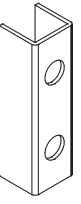
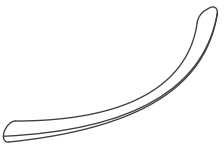
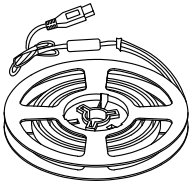
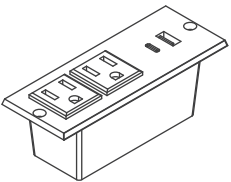
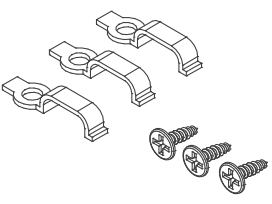
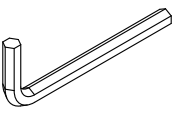
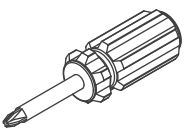
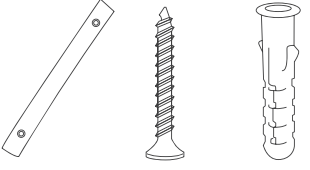
Accessories

<p>1 x6</p>  <p>M6 1 Spare</p>	<p>2 x9</p>  <p>M5x9 1 Spare</p>	<p>3 x5</p>  <p>M6x12 1 Spare</p>	<p>4 x44</p>  <p>M6x23 3 Spares</p>
<p>5 x5</p>  <p>M6.3x45 1 Spare</p>	<p>6 x26</p>  <p>ST4x12 2 Spares</p>	<p>7 x3</p>  <p>ST4x12 1 Spare</p>	<p>8 x3</p>  <p>1 Spare</p>
<p>9 x4</p> 	<p>10 x12</p> 	<p>11 x1</p> 	<p>12 x1</p> 
<p>13 x1</p> 	<p>14 x2</p> 	<p>15 x1</p> 	<p>16 x2</p> 



Assembly Instructions

Step1

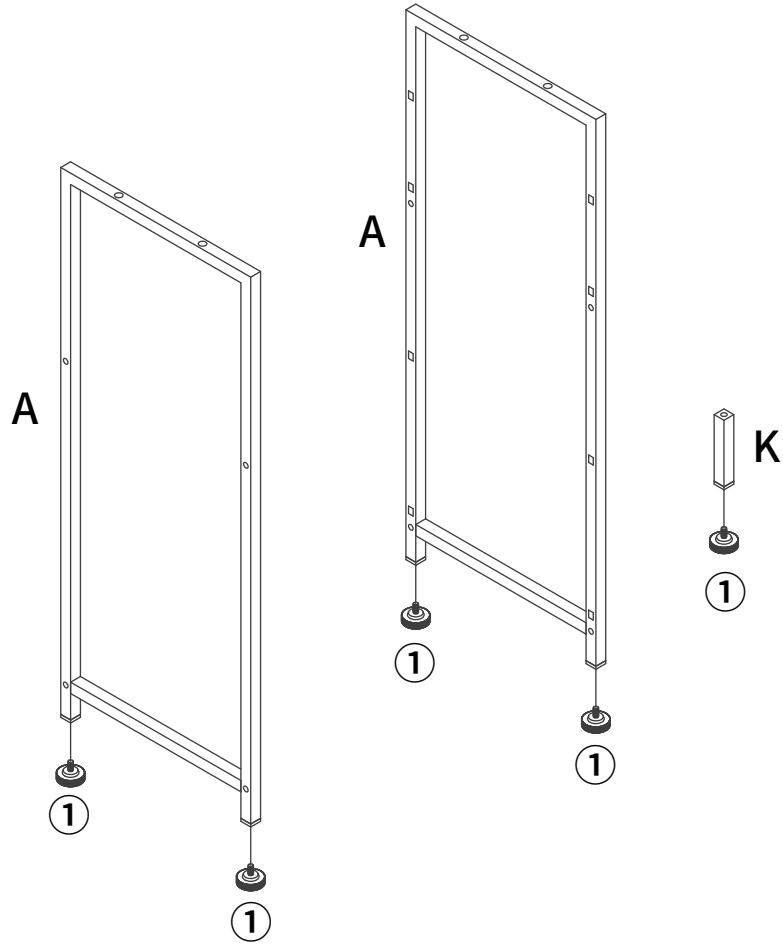
A x2	
K x1	
1 x5	



Step2

G x2	
2 x2	
9 x2	

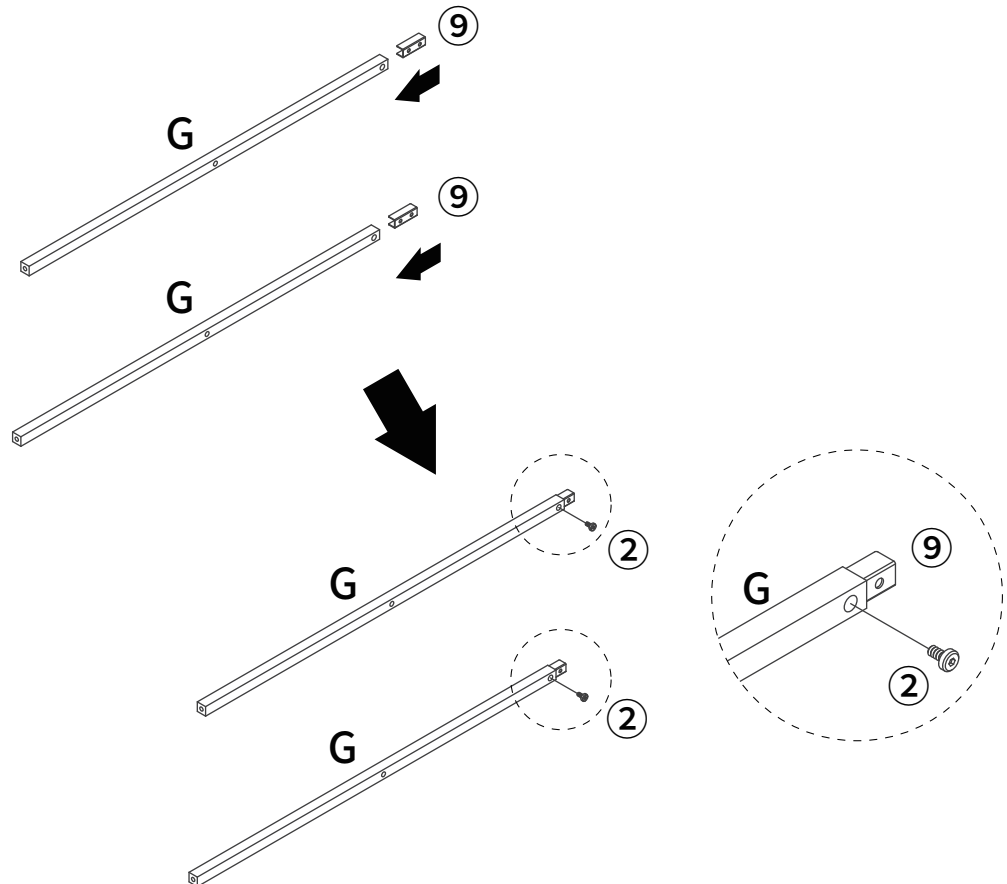

Assembly Instructions

Step3

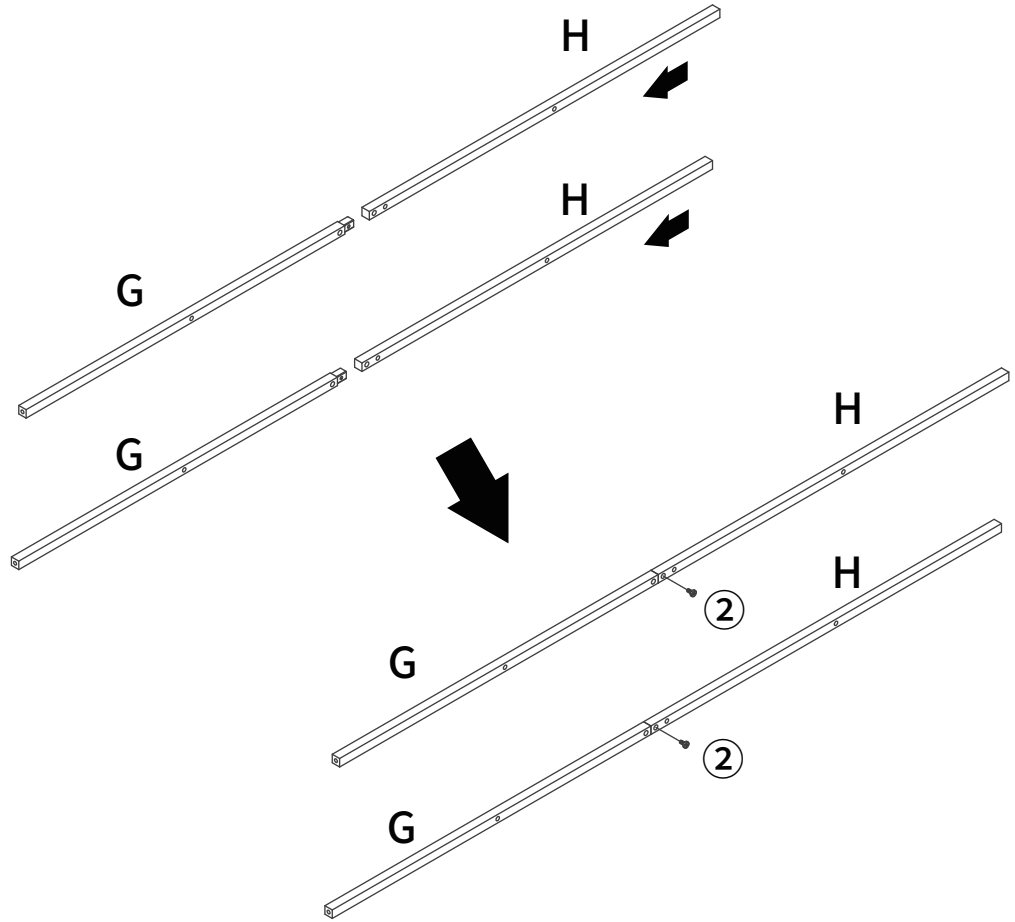
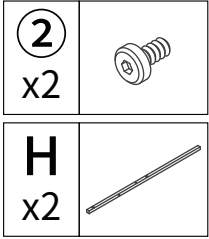

Step4

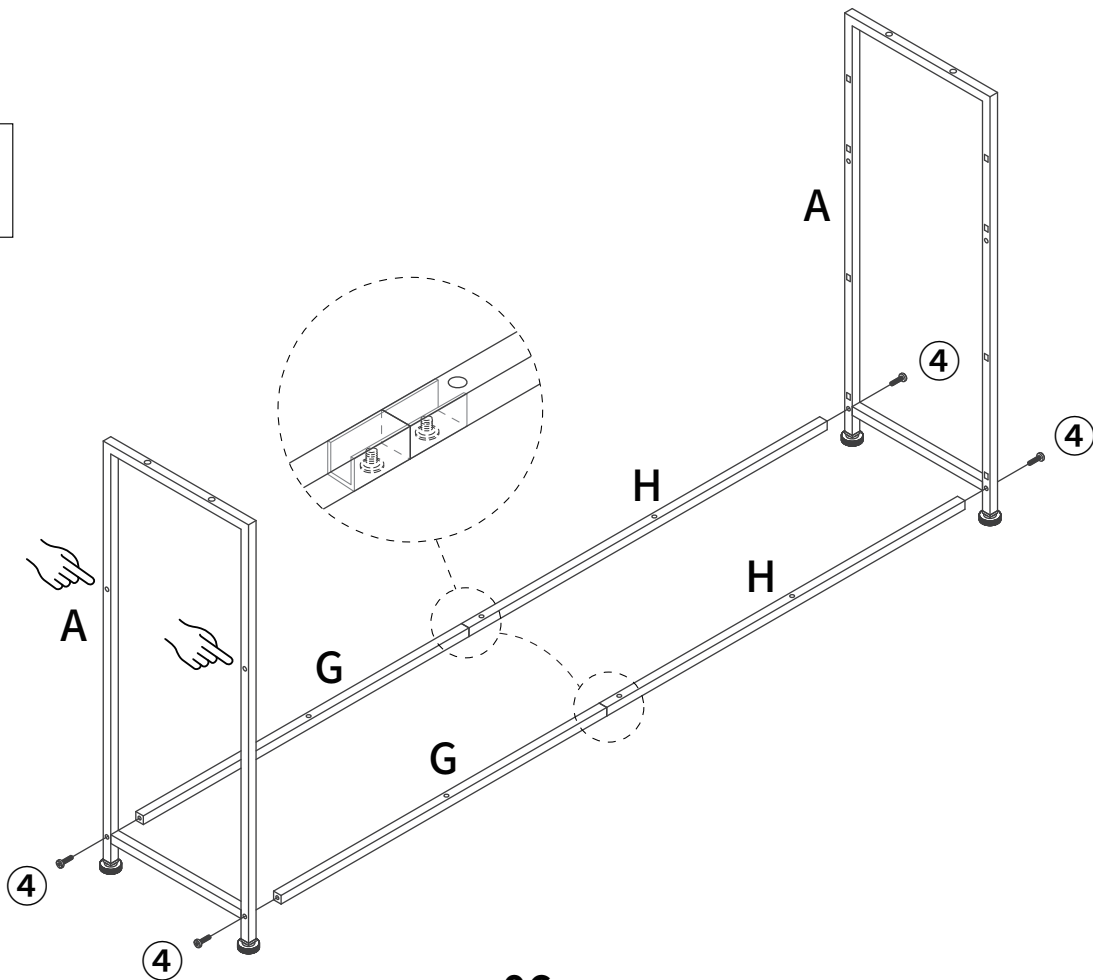
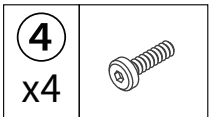

Assembly Instructions

Step5

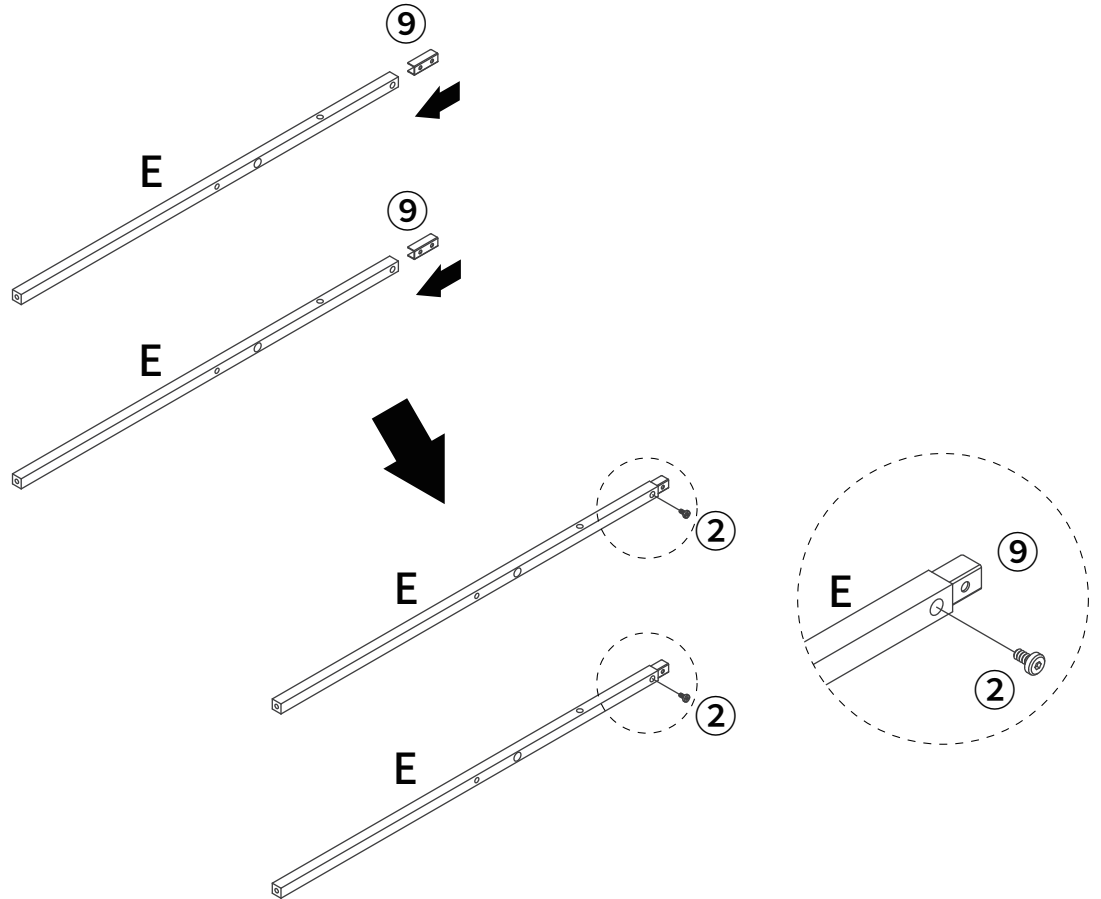
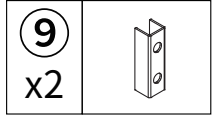
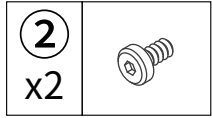
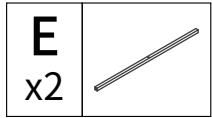

Step6

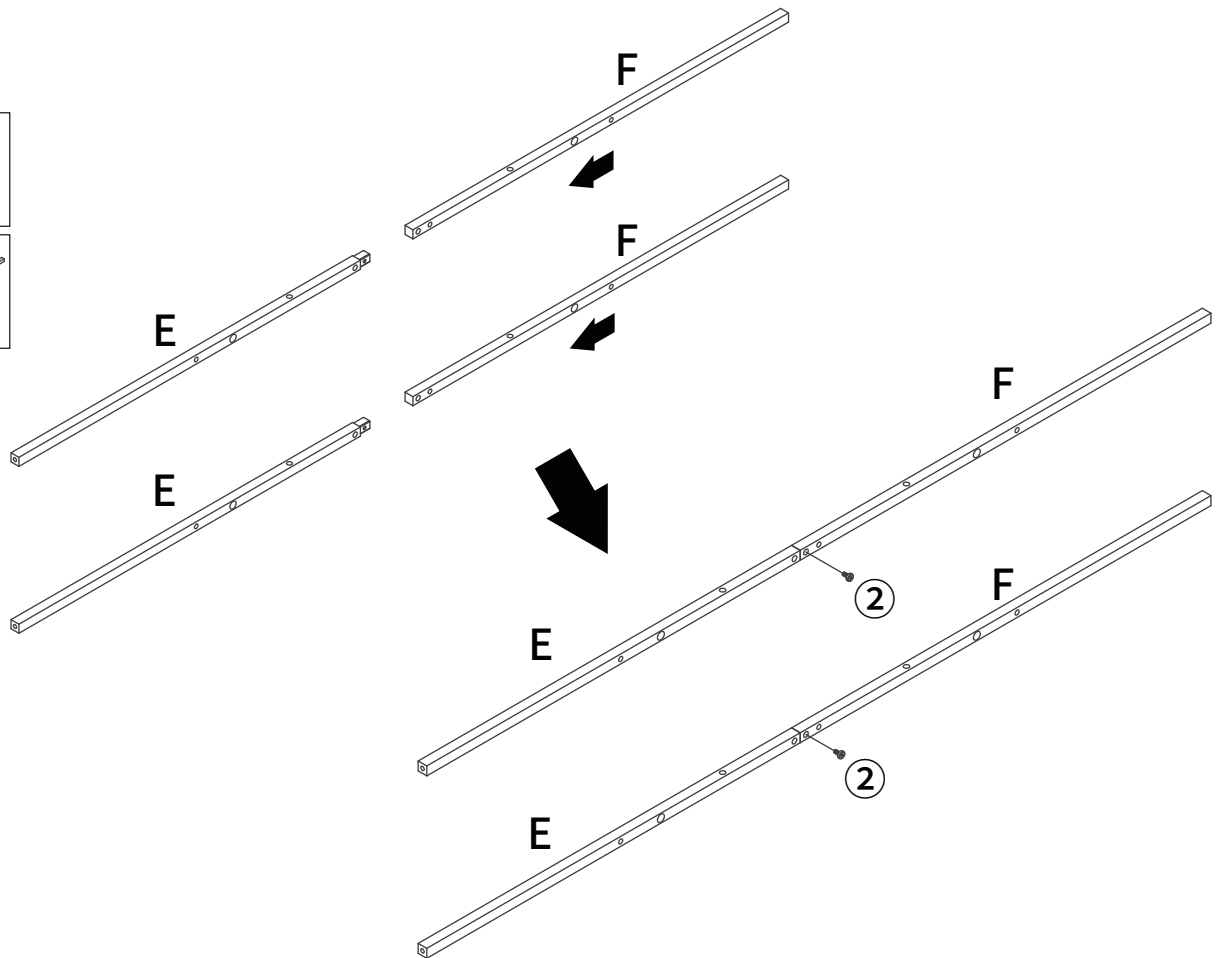
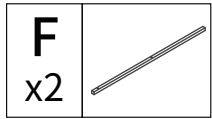
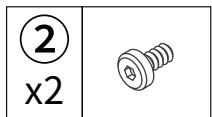

Assembly Instructions

Step 7

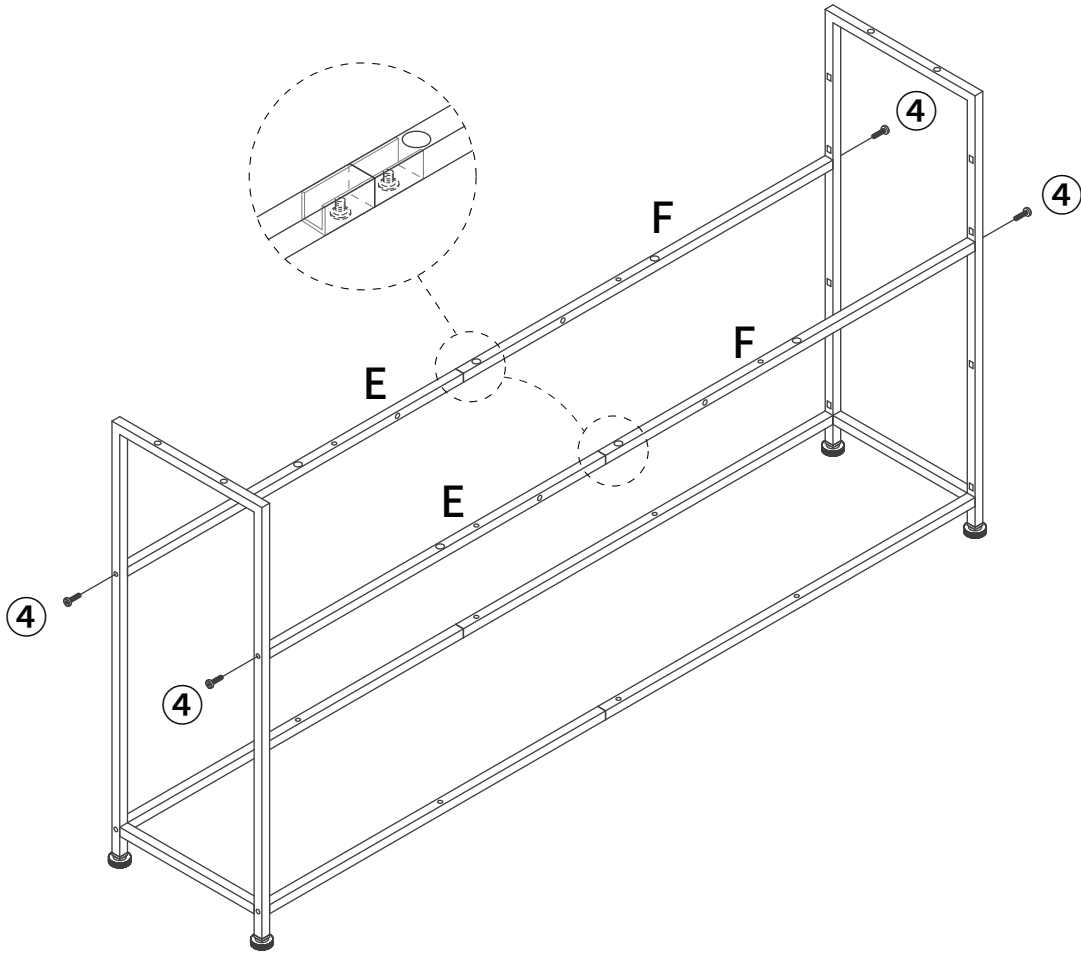
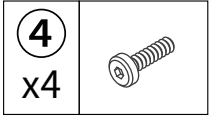

Step 8

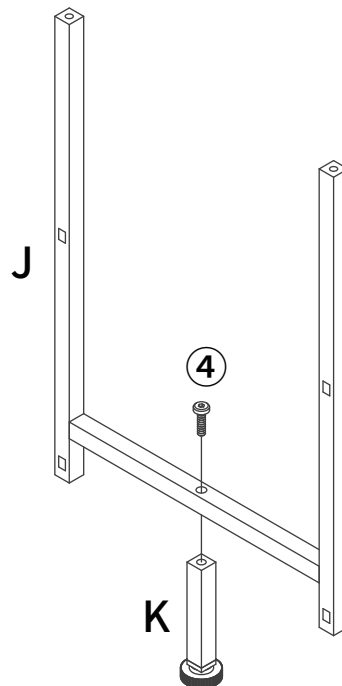
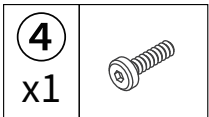
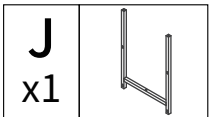

Assembly Instructions

Step9

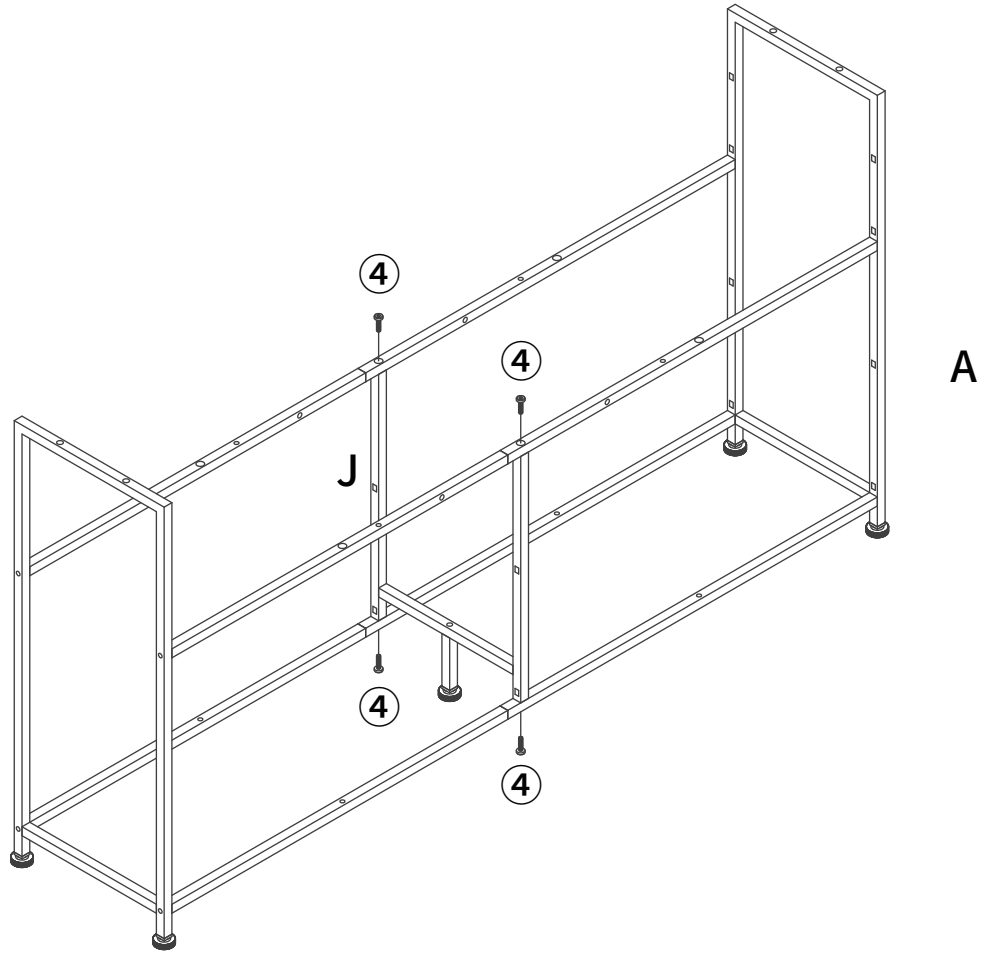
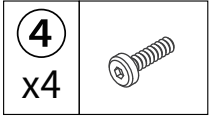

Step10

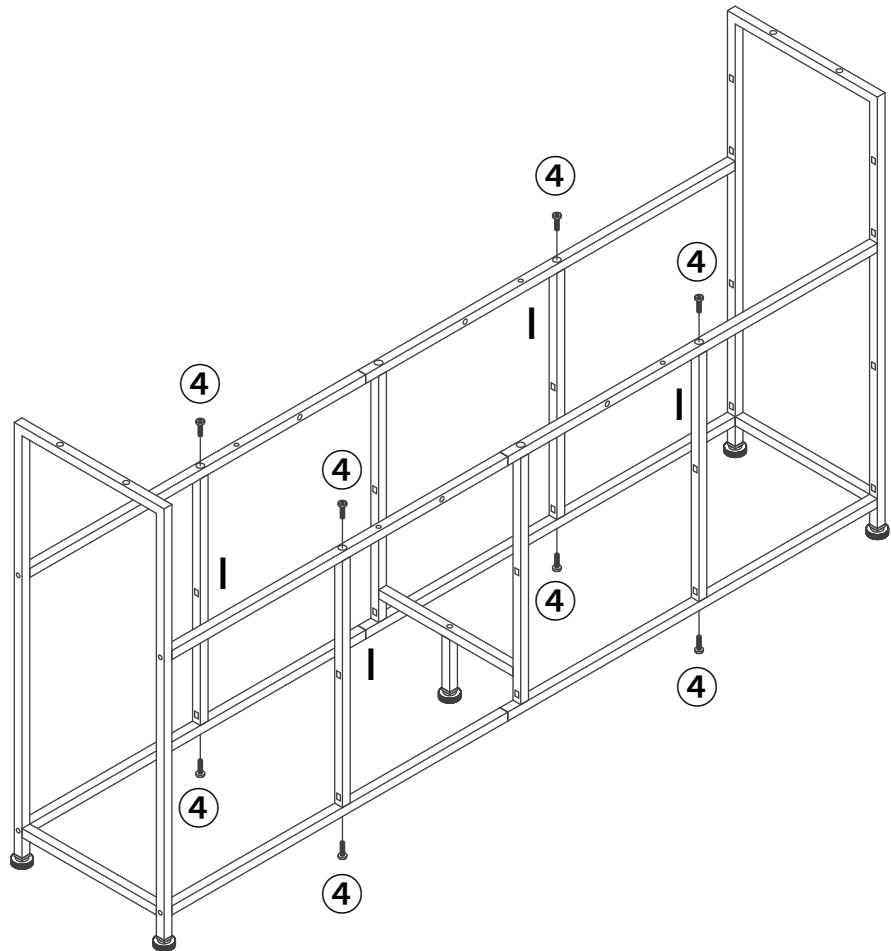
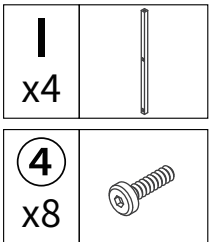

Assembly Instructions

Step11

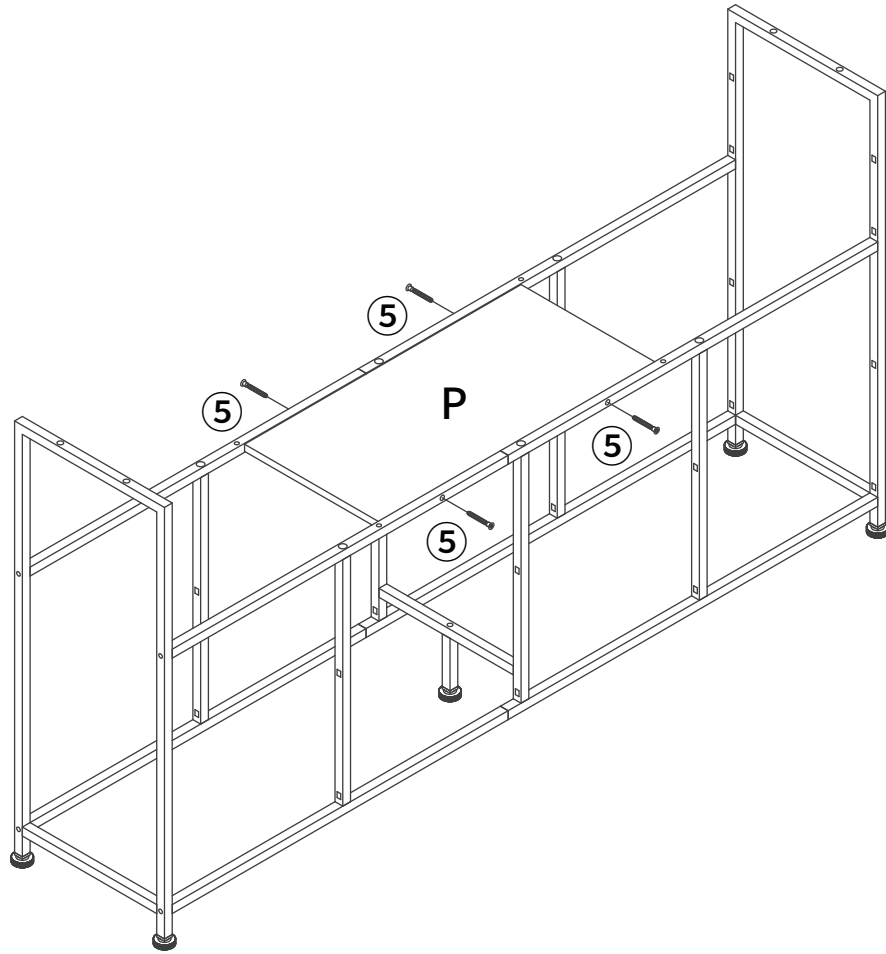
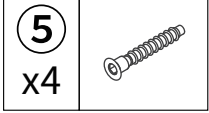
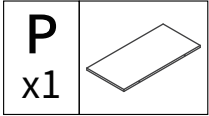

Step12

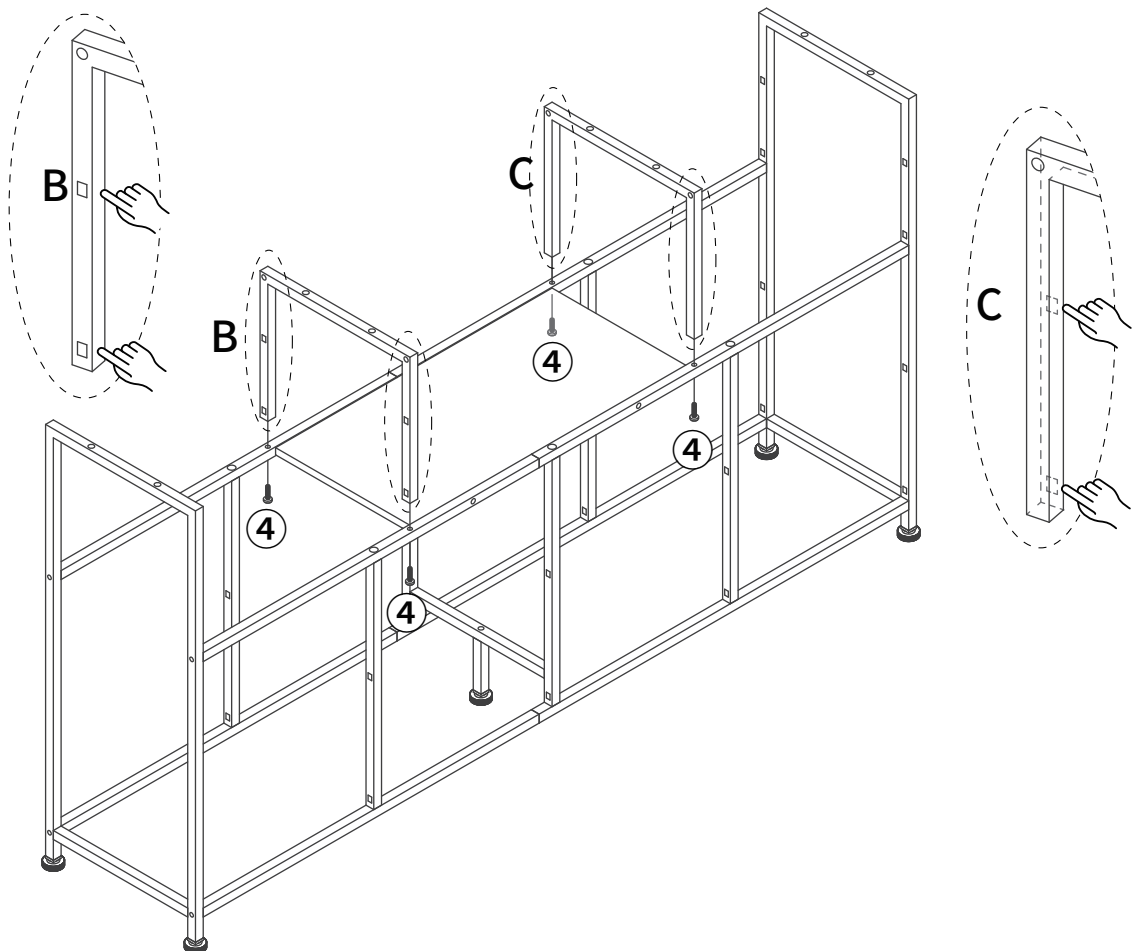
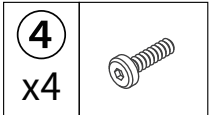
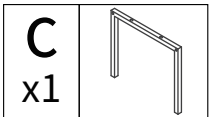
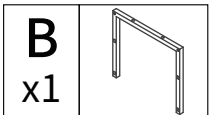

Assembly Instructions

Step13

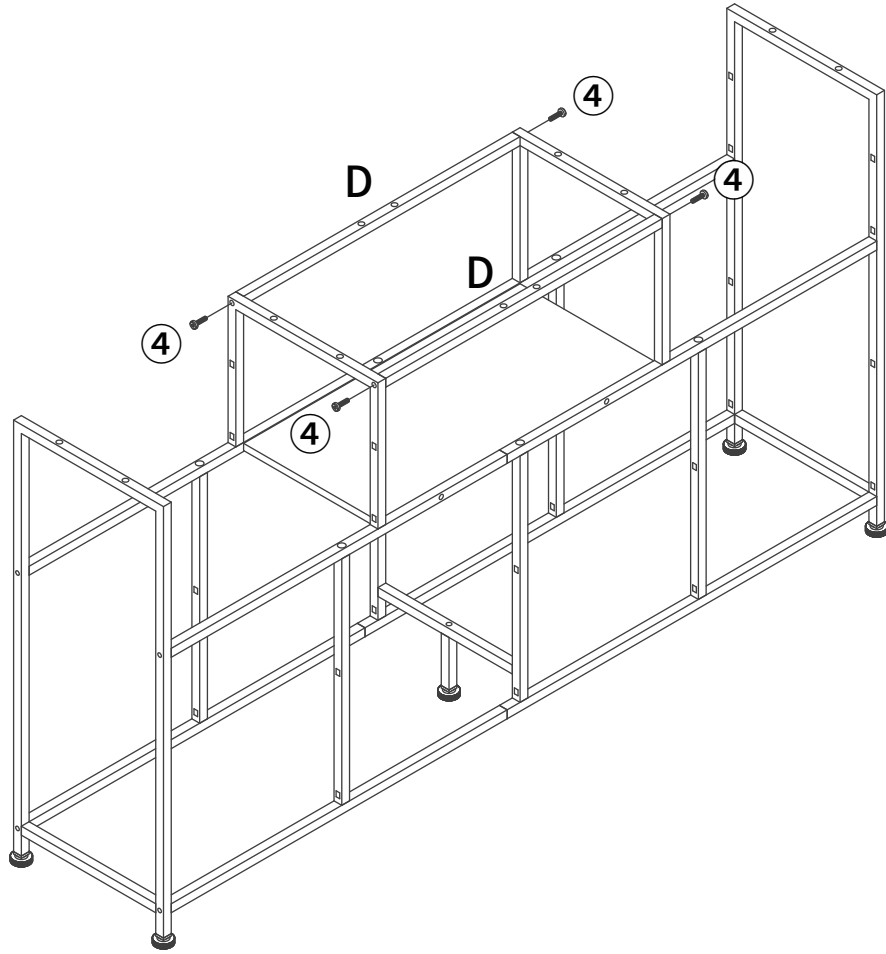
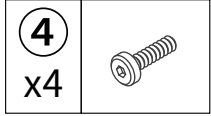
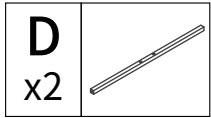

Step14

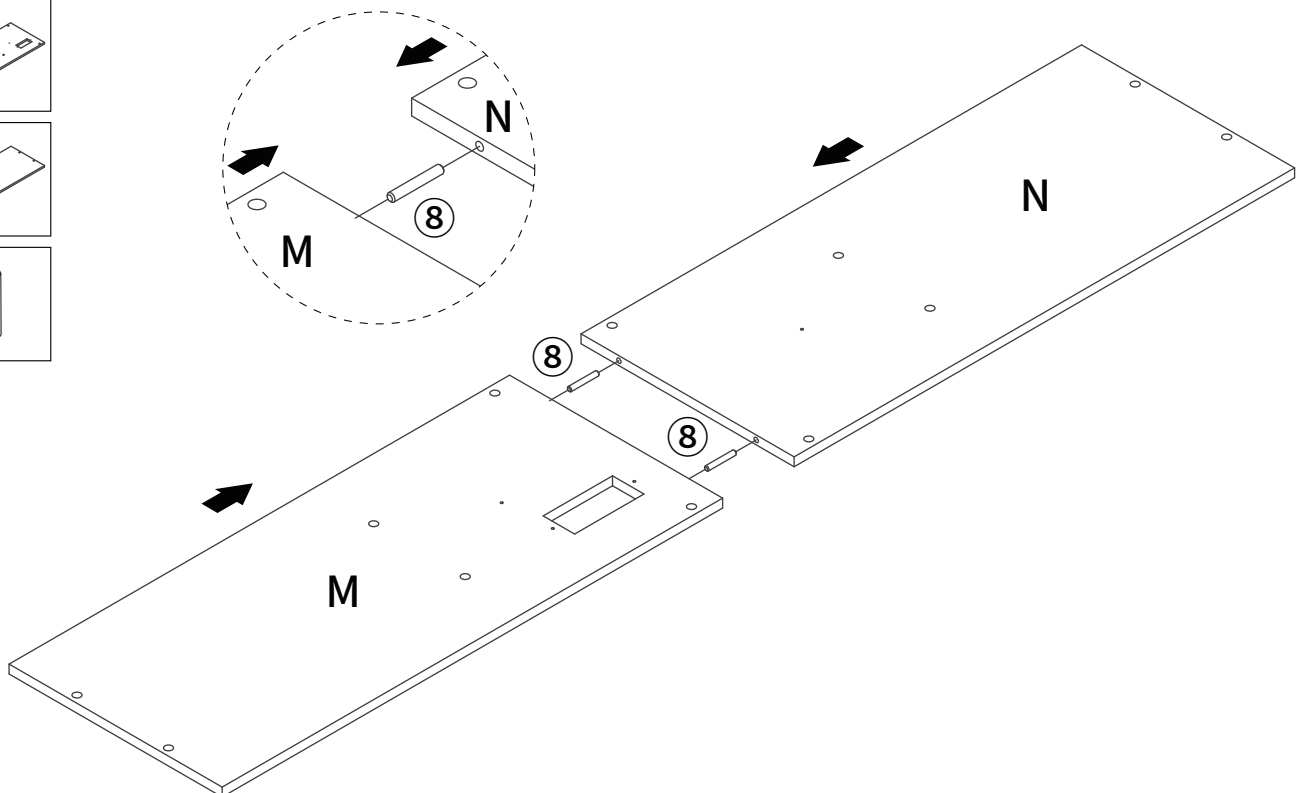
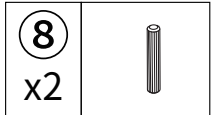
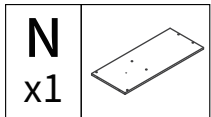
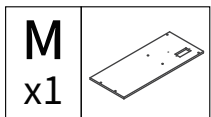

Assembly Instructions

Step15

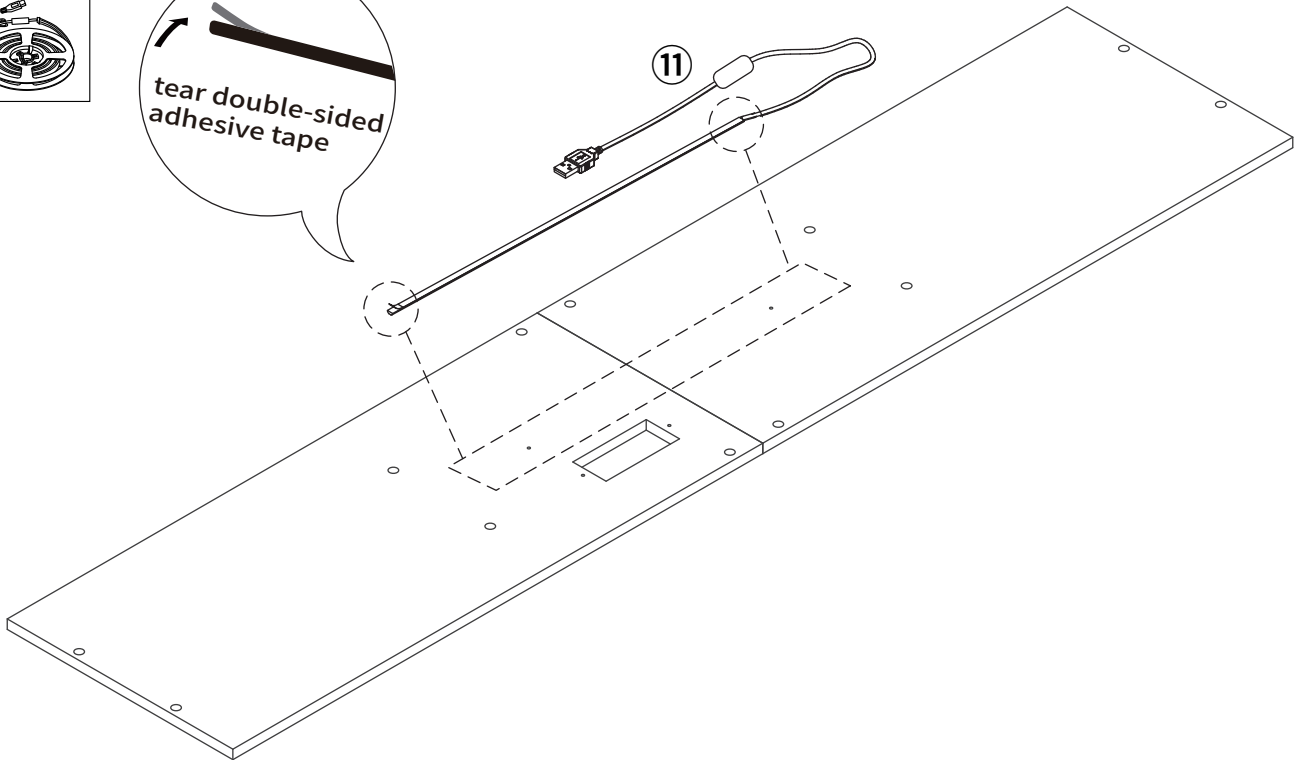
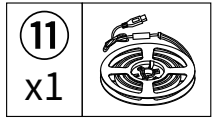

Step16

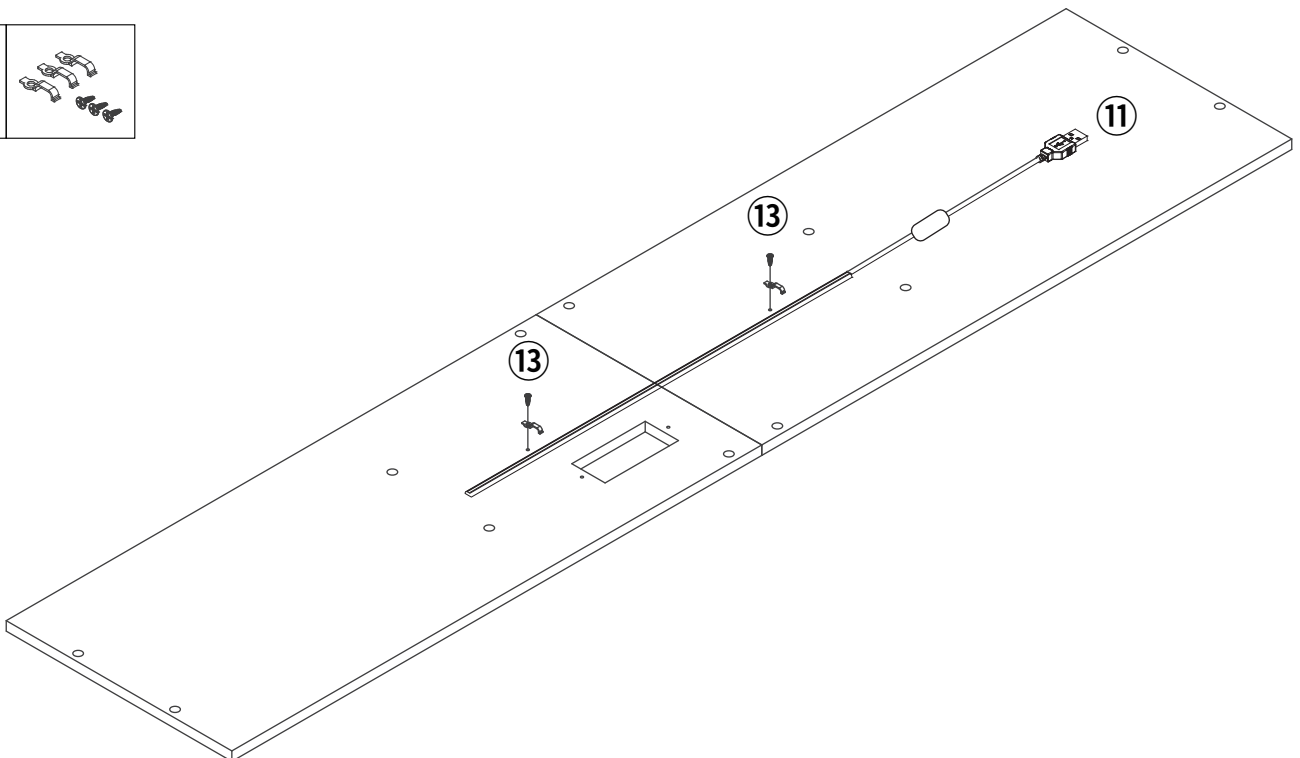
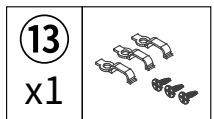

Assembly Instructions

Step17

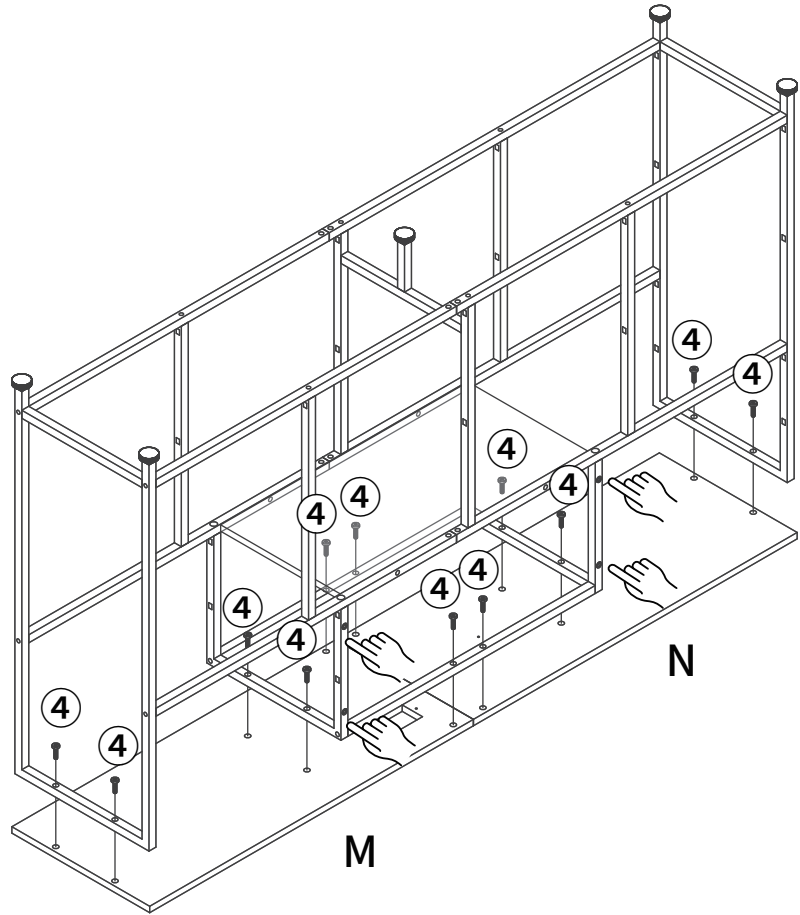
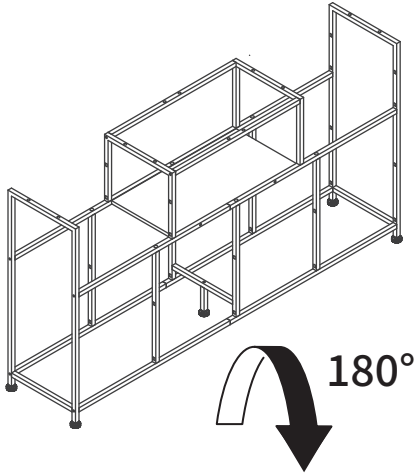
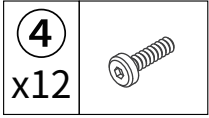

Step18

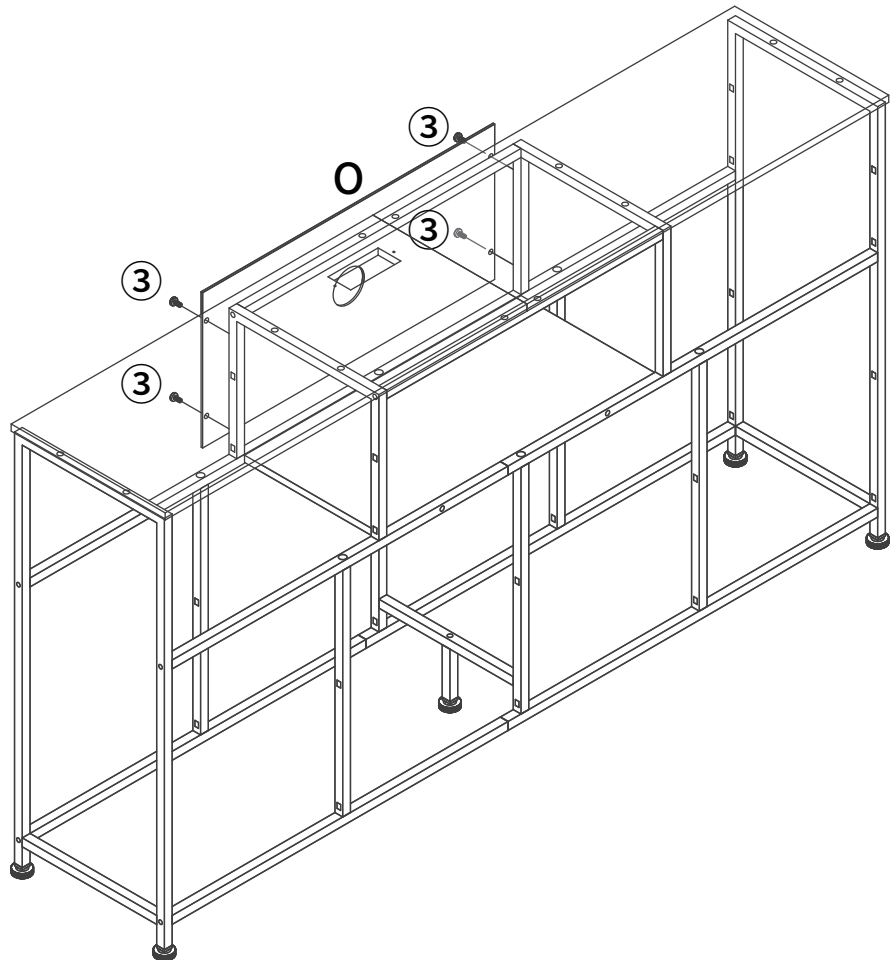
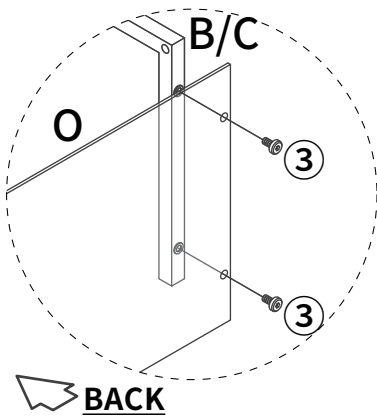
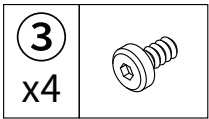
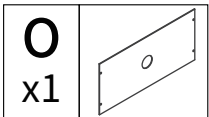

Assembly Instructions

Step19

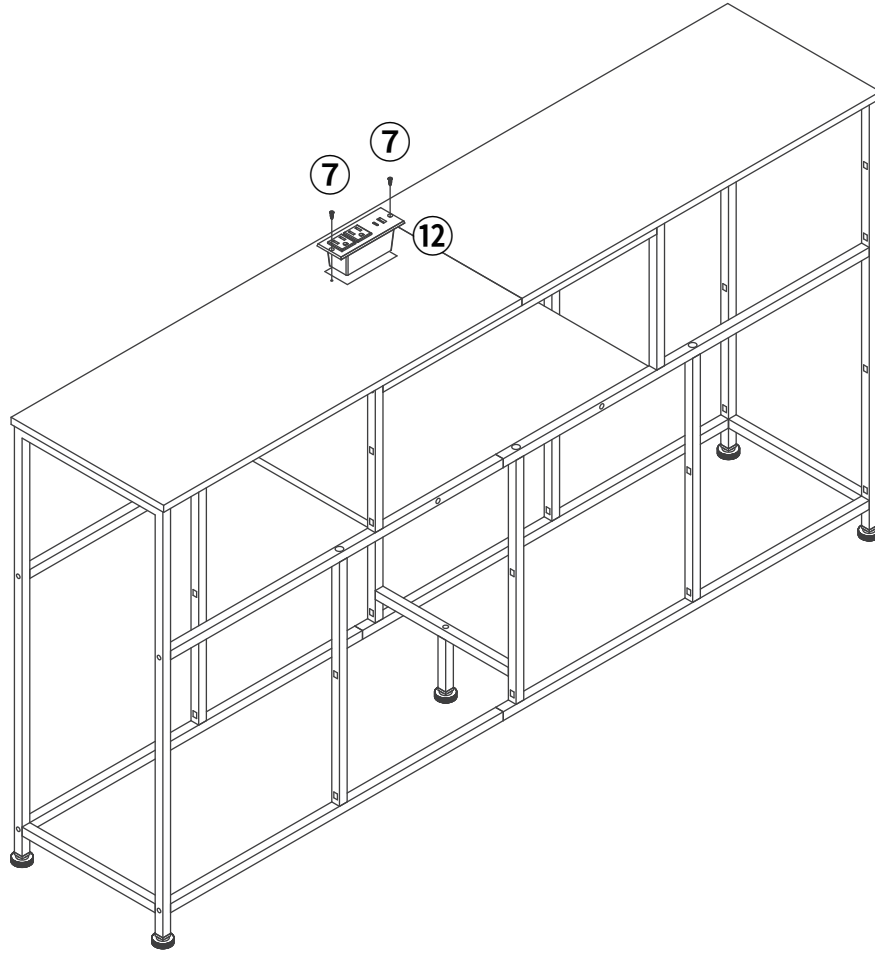
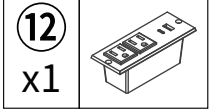
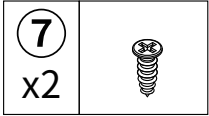

Step20

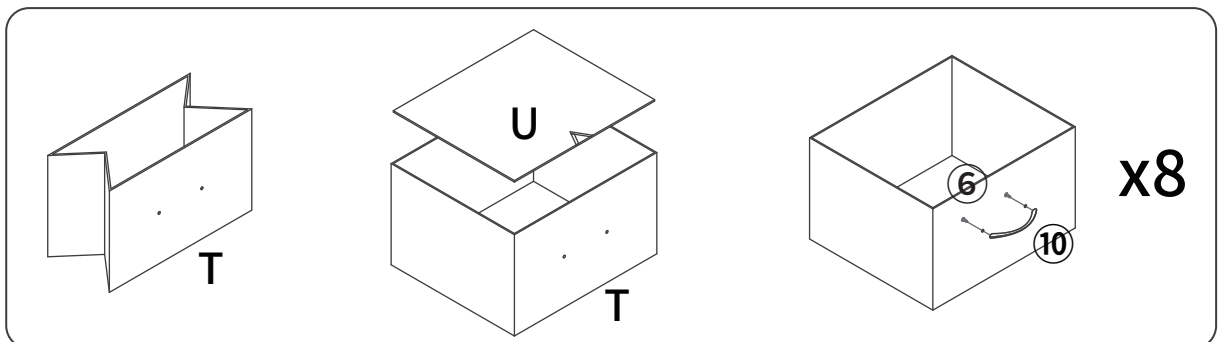
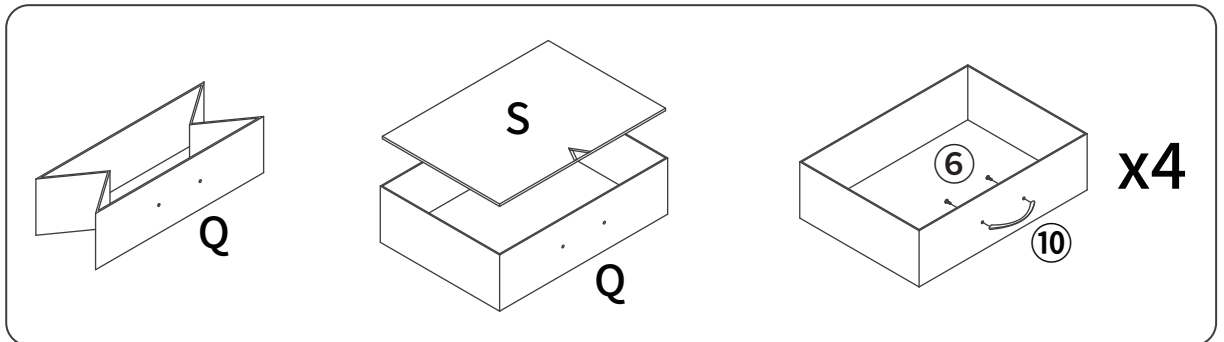
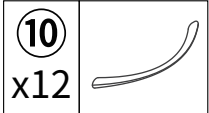
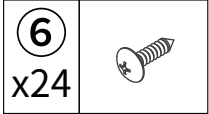
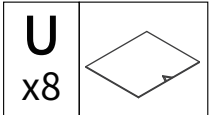
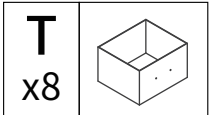
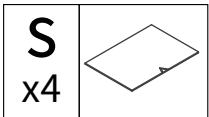
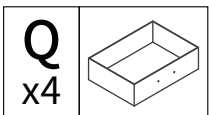

ASSEMBLY INSTRUCTION

- How to distinguish between guide rails L and R.

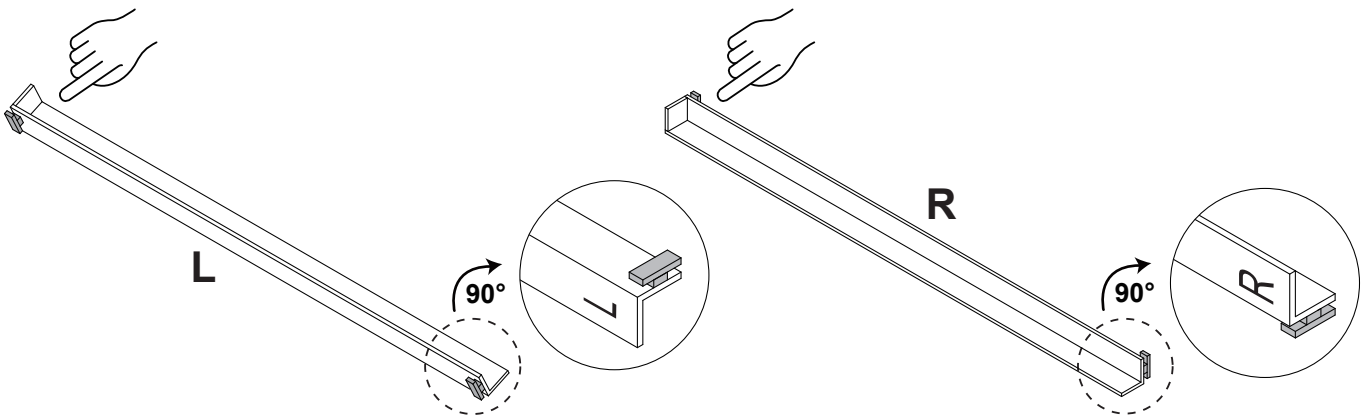

- To install the guide rails, follow the steps and first insert the top of buckles into holes as illustrated.

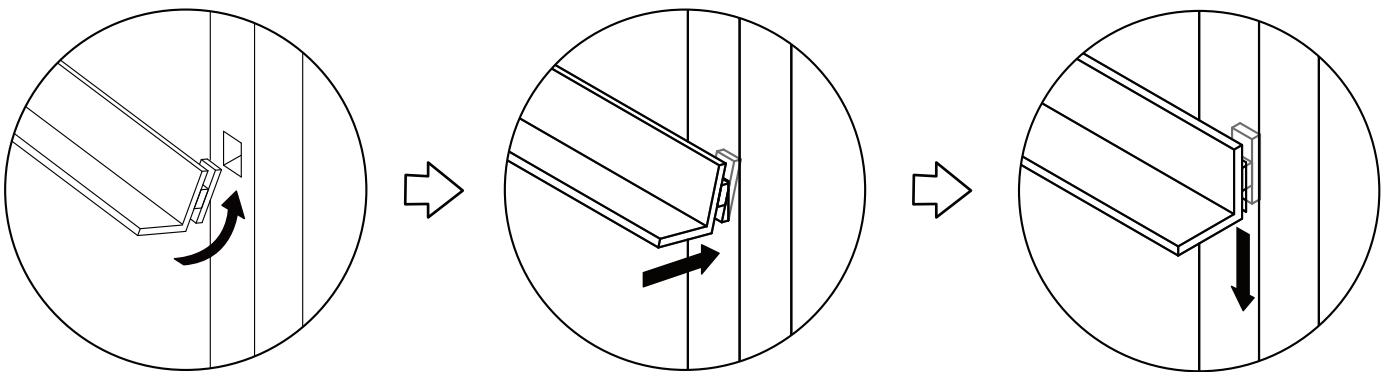

- Refer to the correct installation method.

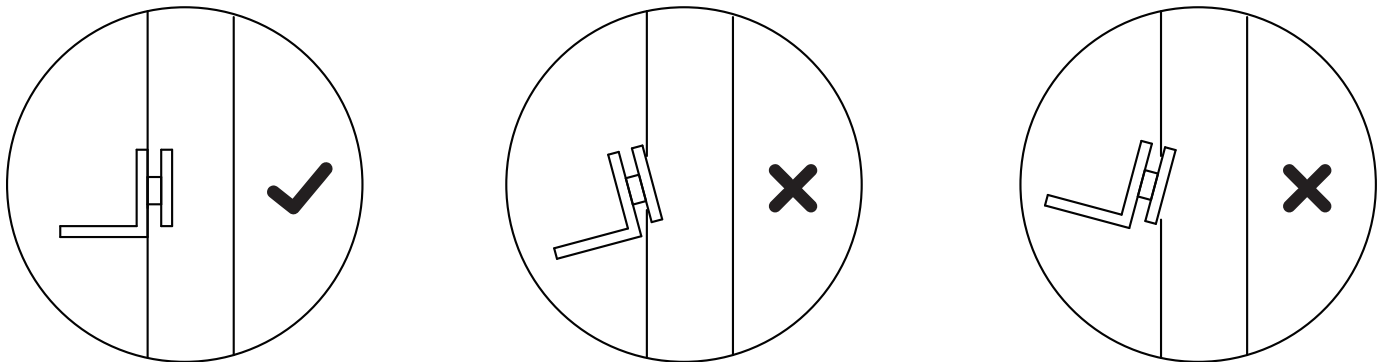

Assembly Instructions

Step21

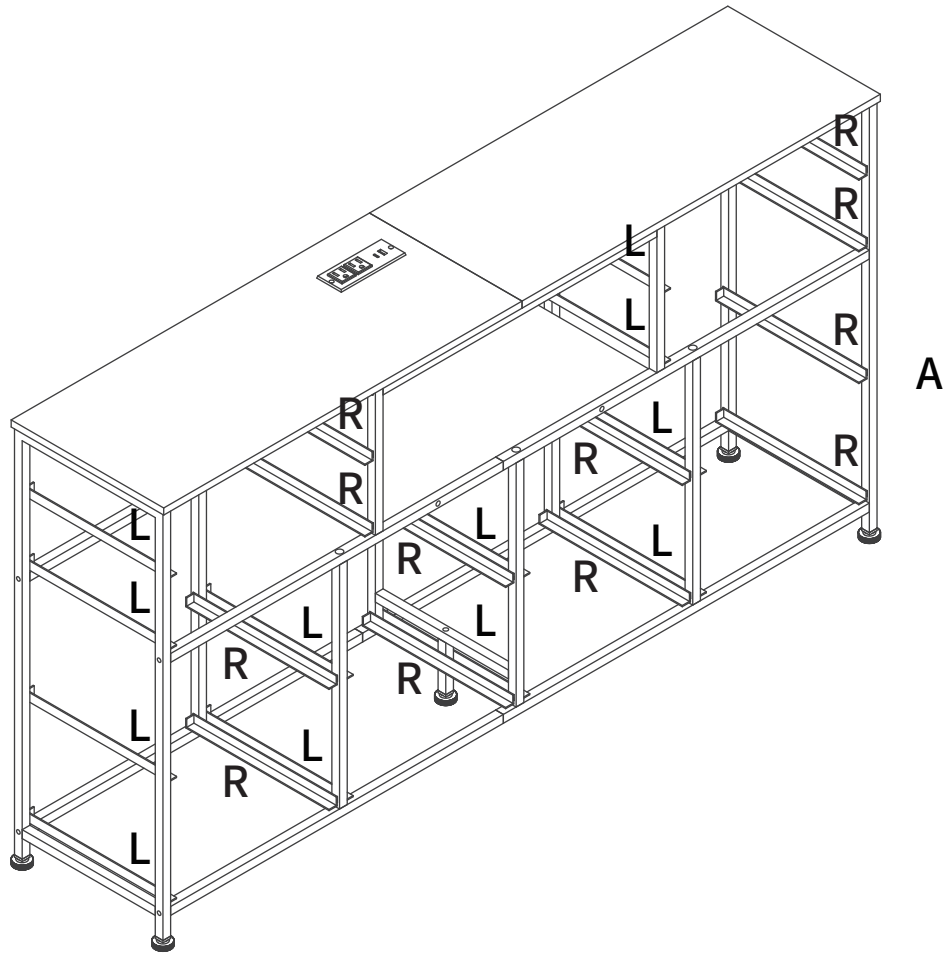
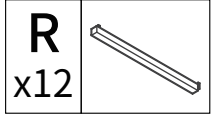
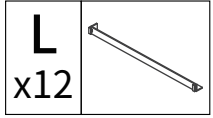

Step22

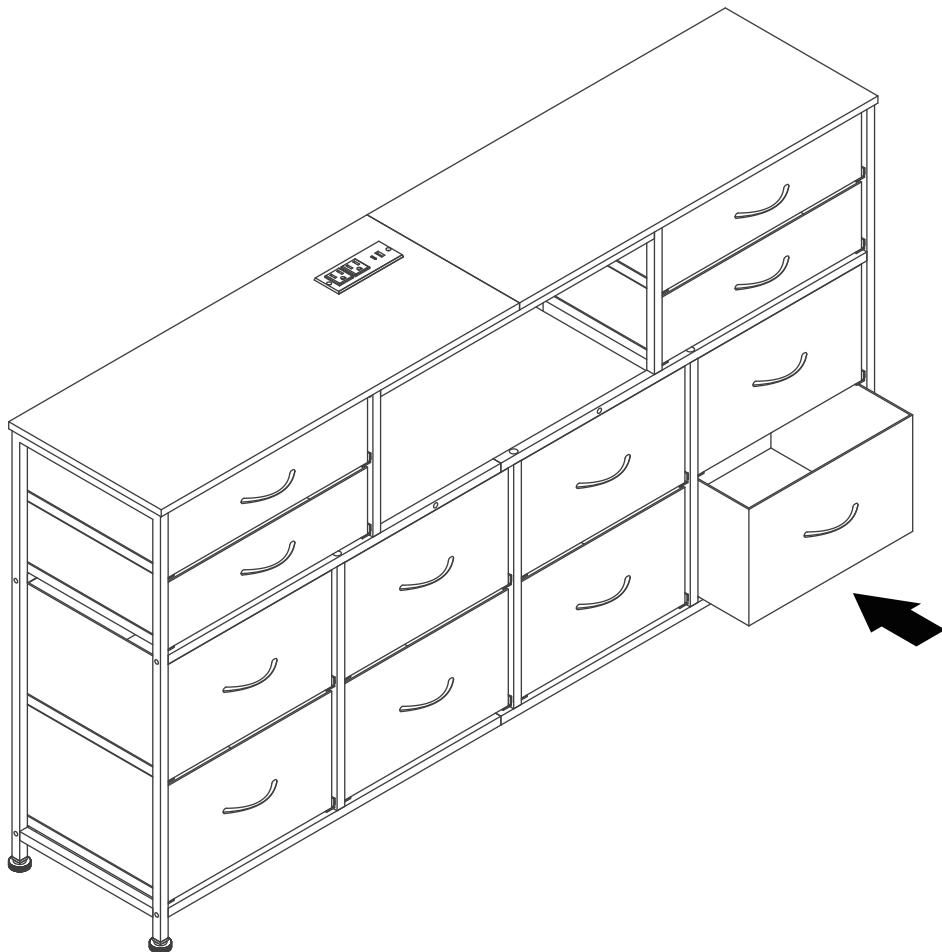

Assembly Instructions

Step 23

