

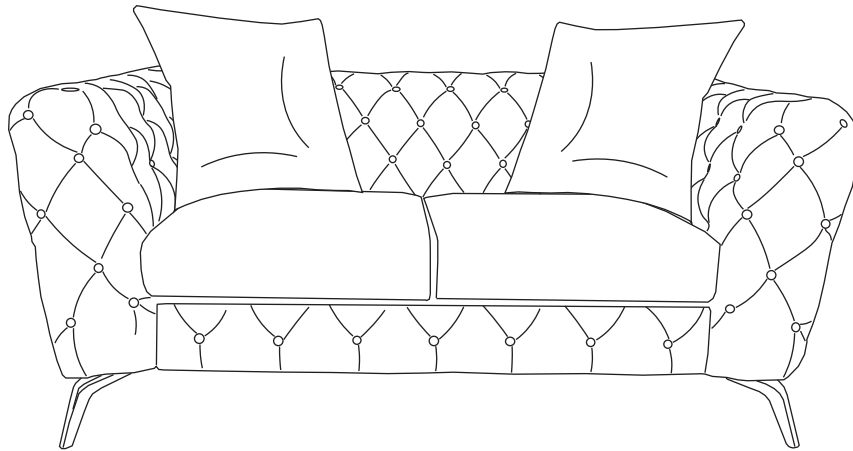



# ASSEMBLY INSTRUCTIONS

WF304183/84/87

2 SEATER SOFA

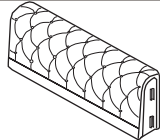

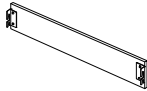
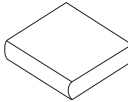
2 SEATER SOFA is packed in 3 cases

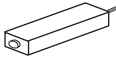
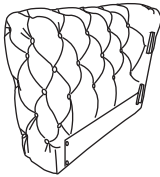
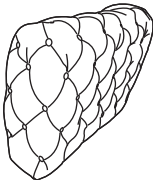
Carton	Disignation	Part	Hardware
1/3 WF304183	Backrest	#1 	
	Riser plate	#2 	
	Former board	#3 	
2/3 WF304184	Cushion	#4 	#A #B #C #D
	Pillow	#5 	
	Leg	#6 	
	Support leg	#7 	
3/3 WF304187	Left arm	#8 	
	Right arm	#9 	

# ASSEMBLY INSTRUCTIONS

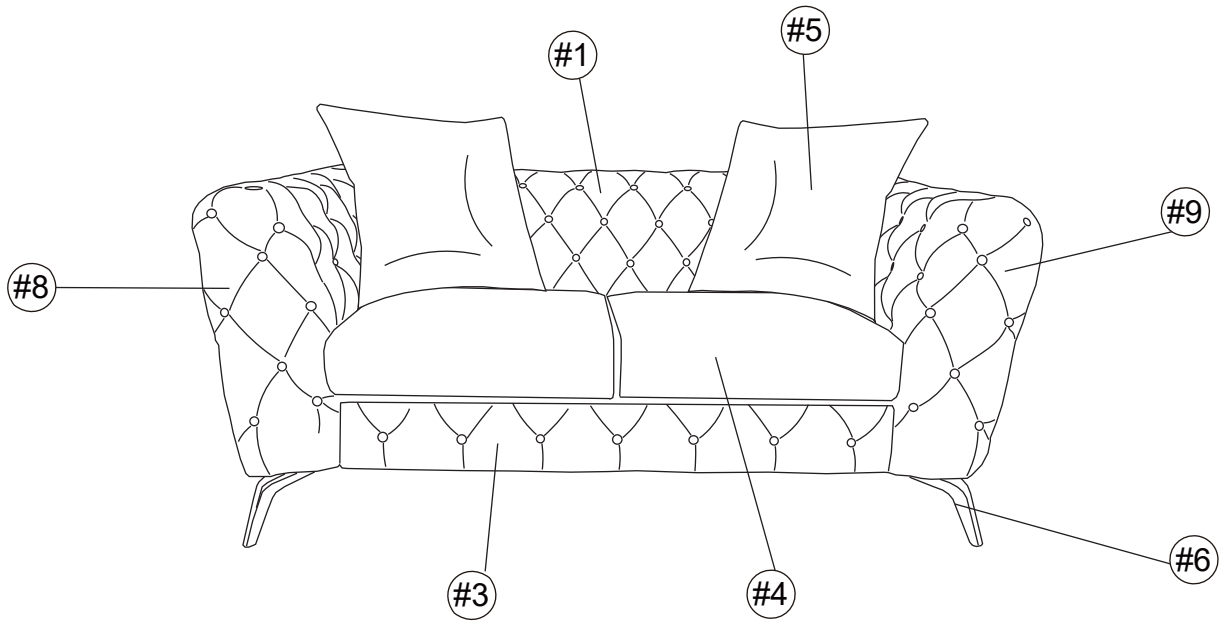

## PARTS

#1 1pc

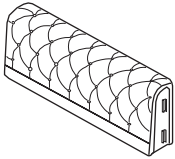

BACKREST

#2 1pc



RISER PLATE  
1120\*555MM

#3 1pc

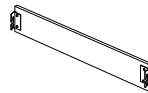

FORMER BOARD

#4 2pcs

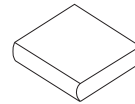

CUSHION

#5 2pcs



PILLOW

#6 4pcs

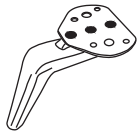

LEG

#7 3pcs

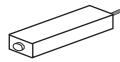

SUPPORT LEG  
30\*30\*255MM

#8 1pc



LEFT ARM

#9 1pc

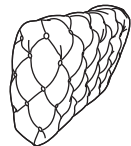

RIGHT ARM

## HARDWARE

#A 12 pcs



BOLT 1-1/2" L

#B 1 pc



ALLEN KEY 4mm L

#C 12 pcs



SPRING WASHER

#D 12 pcs



FLAT WASHER 16mm

# ASSEMBLY INSTRUCTIONS

## STEP1:

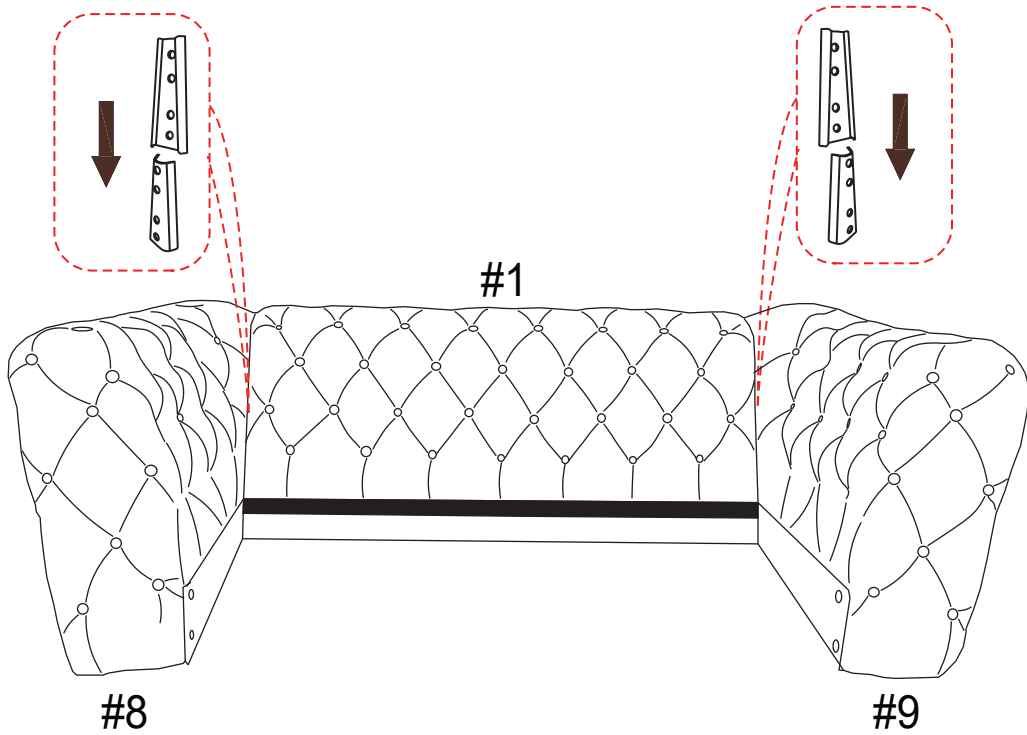

## STEP2:

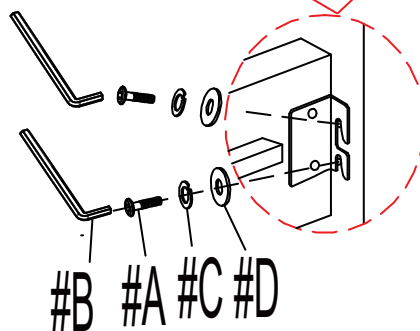
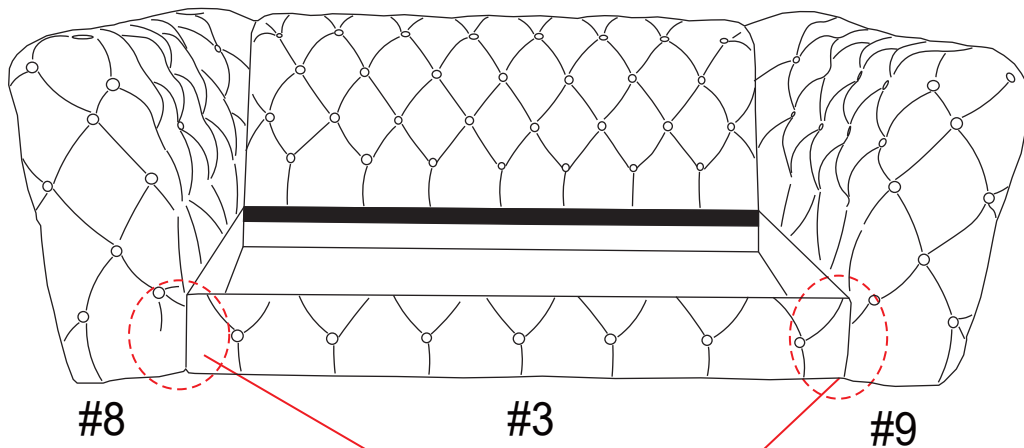

# ASSEMBLY INSTRUCTIONS

STEP3:

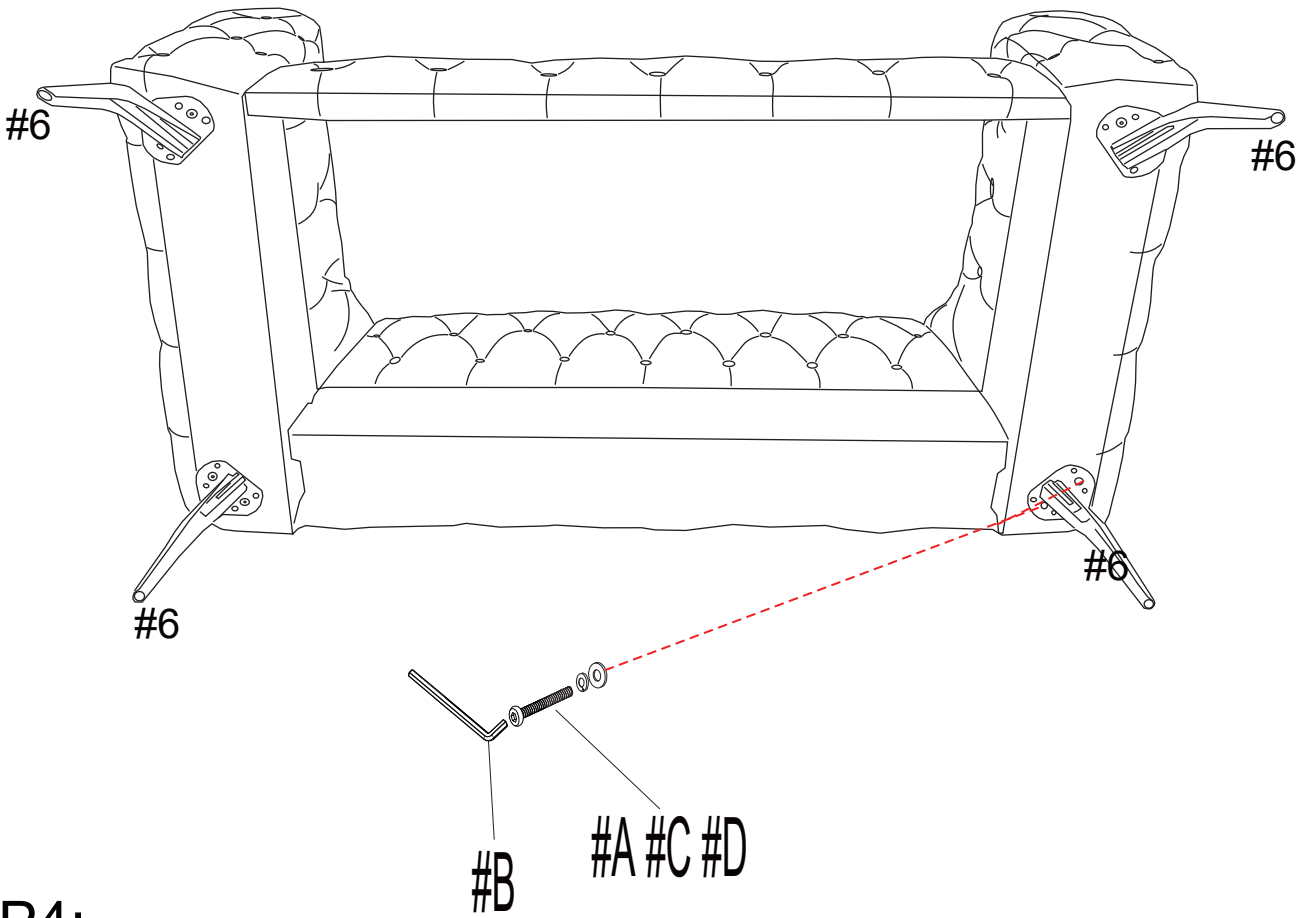

STEP4:

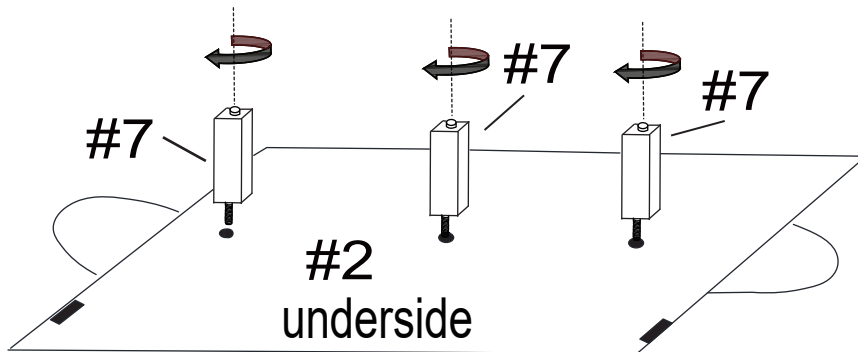

# ASSEMBLY INSTRUCTIONS

---

STEP5:

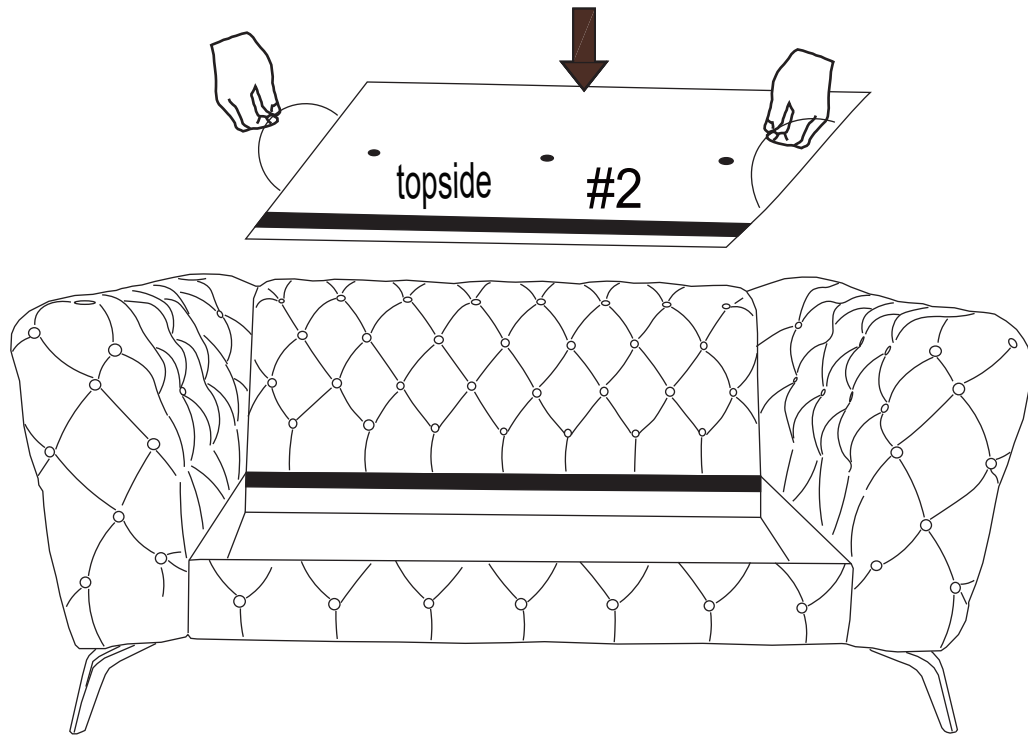

STEP6:

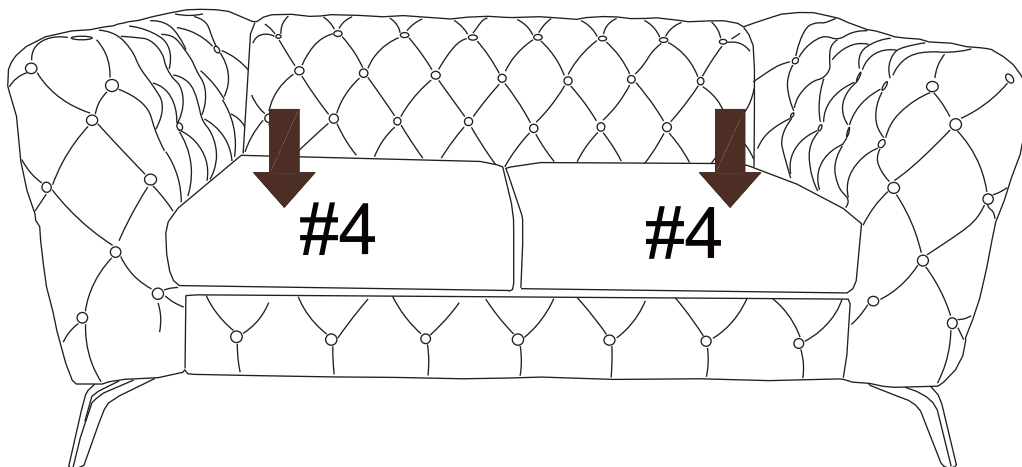

# ASSEMBLY INSTRUCTIONS

---

STEP 7:

