

BAR STOOL

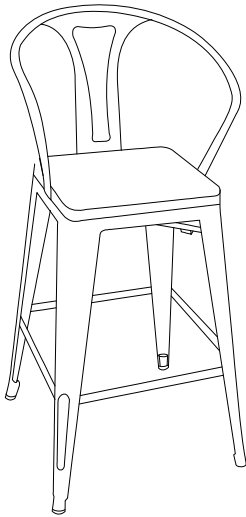



Thank you for purchasing the **BARSTOOL** !

Before you start, here is some helpful advice:

1. We suggest you spend a short time reading through this leaflet and then follow the simple step-by-step instructions.
 2. Owing to the size and weight of the barstool, we recommend that it is assembled by two adults, on a carpeted or padded area, in the room that it is intended for. Approximate assembly time: 30 minutes.
 3. Please do not use any tools other than those provided or recommended in these instructions.
 4. Please do not throw away any of the packaging or the instruction until you have checked all the components and hardware and the furniture is fully assembled. Please ensure that the packaging is disposed of in a safe and environmentally friendly way.
 5. Assemble all components loosely until advised to tighten. Depending on use, it may be necessary to tighten the components from time to time, so please save the tools that have been provided.
 6. Please keep all fitting out of reach of children.
-



Hardware:

A		Bolt M6x14mm	x 4
B		Nut M6	x 4
C		Wrench M6	x 1
D		Allen Wrench M4	x 1

Component:

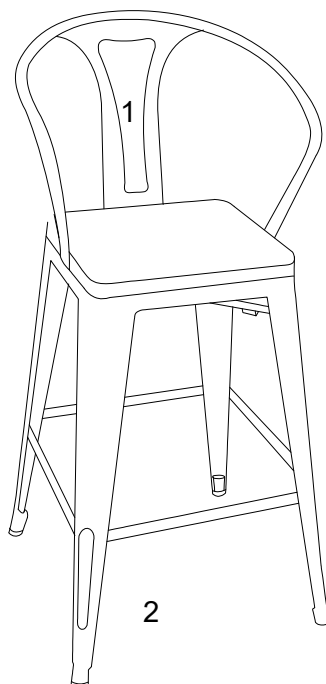

BARSTOOL





STEP 1:

Put **Barstool Base (2)** on a carpeted or padded area.

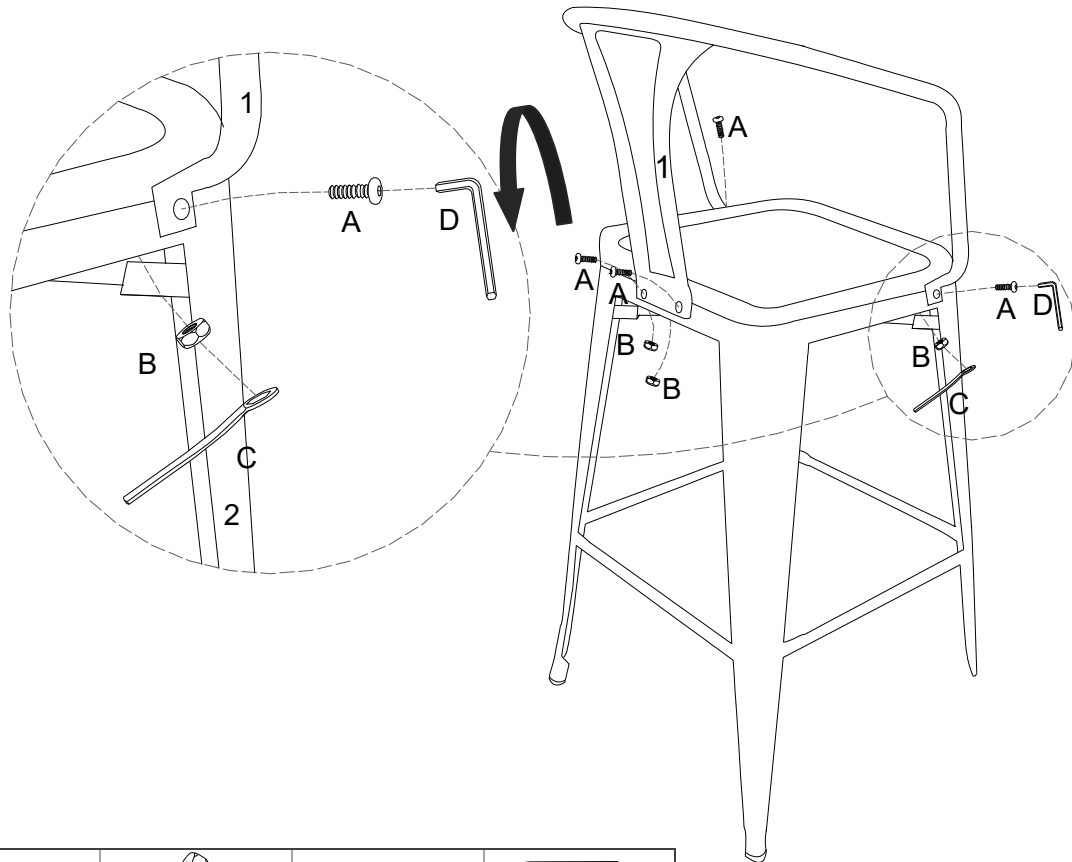
Attach **Barstool Base (2)** to **Barstool Back (1)** by using 4 pieces of **Bolt (A)** and 4 pieces of **Nut (B)** as shown.

Use **Wrench (C)** and **Allen Wrench (D)** to tighten the **Bolts (A)** and **Nut (B)** until secure.



			
Ax4	Bx4	Cx1	Dx1

Hardware & Tool required

STEP 2:

Carefully put the assembled barstool to the place you desired.

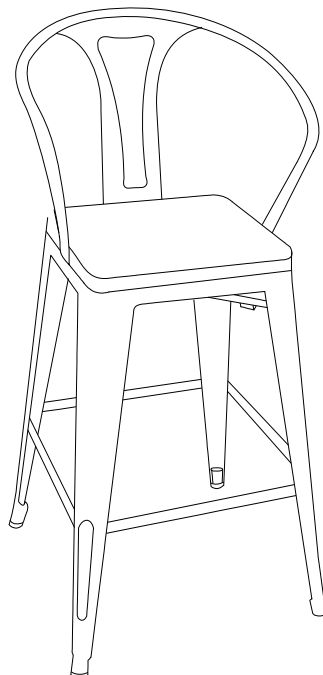

Assembly is complete. Your barstool is ready to be used now!