

Black Clamp-on Keyboard Tray

Instruction Manual

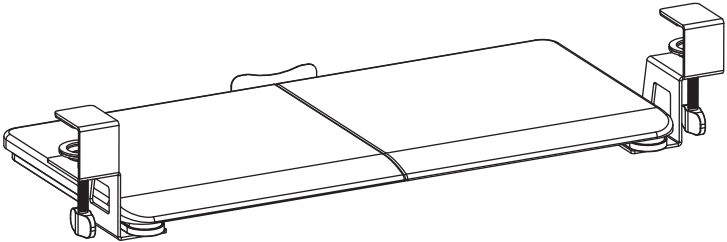



WARNING!

If you do not understand these directions, or if you have any doubts about the safety of the installation, please call a qualified technician. Check carefully to make sure there are no missing or defective parts. Improper installation may cause damage or serious injury. Do not use this product for any purpose that is not explicitly specified in this manual. Do not exceed weight capacity. We cannot be liable for damage or injury caused by improper mounting, incorrect assembly or inappropriate use.



WARNING: CHOKING HAZARD

SMALL PARTS - NOT FOR CHILDREN UNDER 3 YEARS. ADULT SUPERVISION IS REQUIRED.

PACKAGE CONTENTS



A (x2)



B (x8)



C (x6)



D (x2)

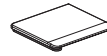

E (x1)

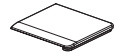

F (x1)



G (x1)



H (x1)



I (x1)

TOOLS NEEDED



DO NOT EXCEED WEIGHT CAPACITY.

Failure to do so may result in serious injury.



ASSEMBLY STEPS

STEP 1

Assemble the Keyboard Tray (E) using Connecting Plates (F) and M5x12 Flat Head Screws (C), and tighten with a Phillips screwdriver.

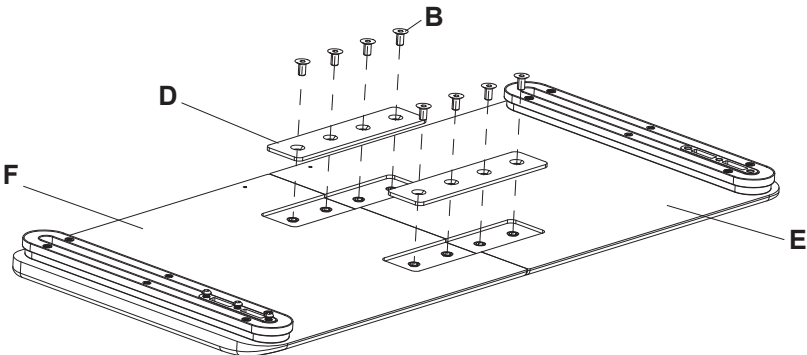

STEP 2

Attach the Keyboard Stop (I) to the back of the Keyboard Tray (E) using M5x12 Flat Head Screws (C). Tighten with a Phillips screwdriver.

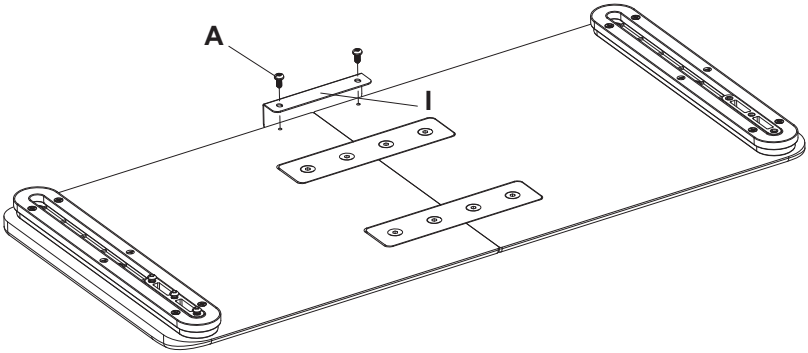

STEP 3

Assemble Clamps (H) to the Slider Brackets (G) using M4x7 Screws (A). Tighten with a Phillips screwdriver.

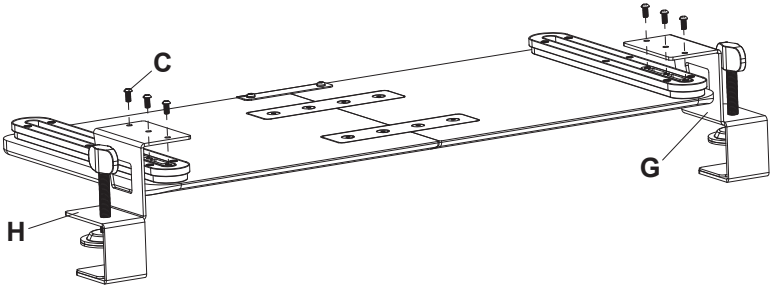

STEP 4

Place Pads (D) on the underside of each clamp. Place assembled keyboard mount on the edge of the desk and tighten clamps.

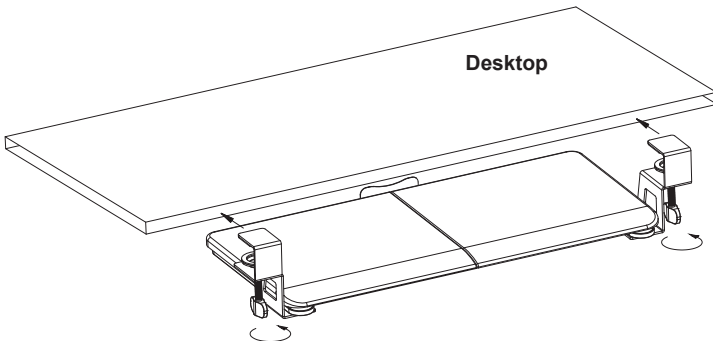

NOTE: To ensure keyboard tray is level, do not over-tighten clamps. Slide keyboard tray forward/back to the desired position.