

NOTICE

- *Please make sure that you have all parts indicated and they are in good condition before you begin assembly of this item. Refer to part list and hardware list below for guidance.
- *This item should be assembled on a soft surface to prevent scratching the finish during assembly.
- *This item may require periodic tightening .
- *If you are having hard difficulty,our friendly Customer Care team is always here to help.









PREPARATION

- * Before beginning the assembly of product, make sure all parts are present. Compare parts with part contents list and hardware contents list.
- * If any part is missing or damaged,do not attempt to assemble the product.
- * Estimated Assembly Time: 20 minutes.
- *Tool required for assembly (included): Allen Key.

CARE AND MAINTENANCE

Store outdoor furniture indoors or cover well when it is not in use.
Dust regularly with small brush or vacuum.Spills should be taken care of immediately before they harden or stain with a slightly dampened sponge.

Part List and Hardware List

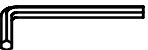
PIECE	DESCRIPTION	PICTURE	QUANTITY
A	Back		1x
B	Seat		1x
C	Right side		1x
D	Left side		1x
E	Support		2x
HW1	T bolt & nut	 M6x70	6x
HW2	Screw	 M4x35	2x
HW3	Extra bolt	 M6x45	1x
HW4	Allen key		1x

Owner Manual

Product Dimension: 22.64"W x 24.02"D x 34.65"H

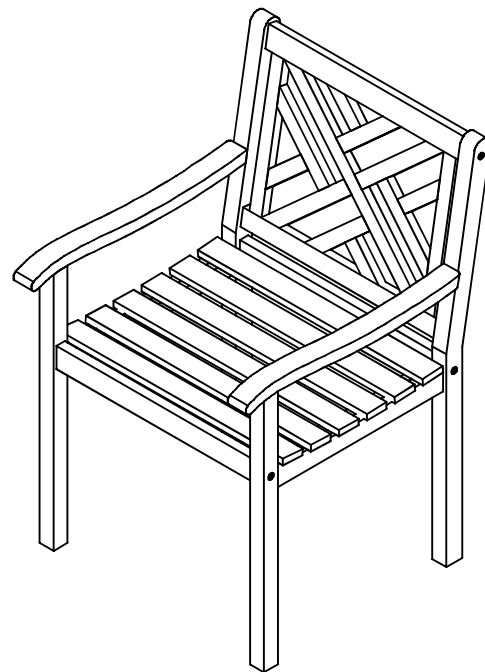

Weight capacity: 300 lbs

Warning: Do not stand on the chair

Warning: Do not torque bolts / screws

PREPARATION

- *Before beginning the assembly of product,make sure all parts are present.Compare parts with part contents list and hardware contents list.
- *If any part is missing or damaged,do not attempt to assemble the product.
- *Estimated Assembly Time:20 minutes.
- *Tool requirement for assembly(included): Allen Key.
- *If you are having difficulty,our friendly Customer Care team is always here to help .

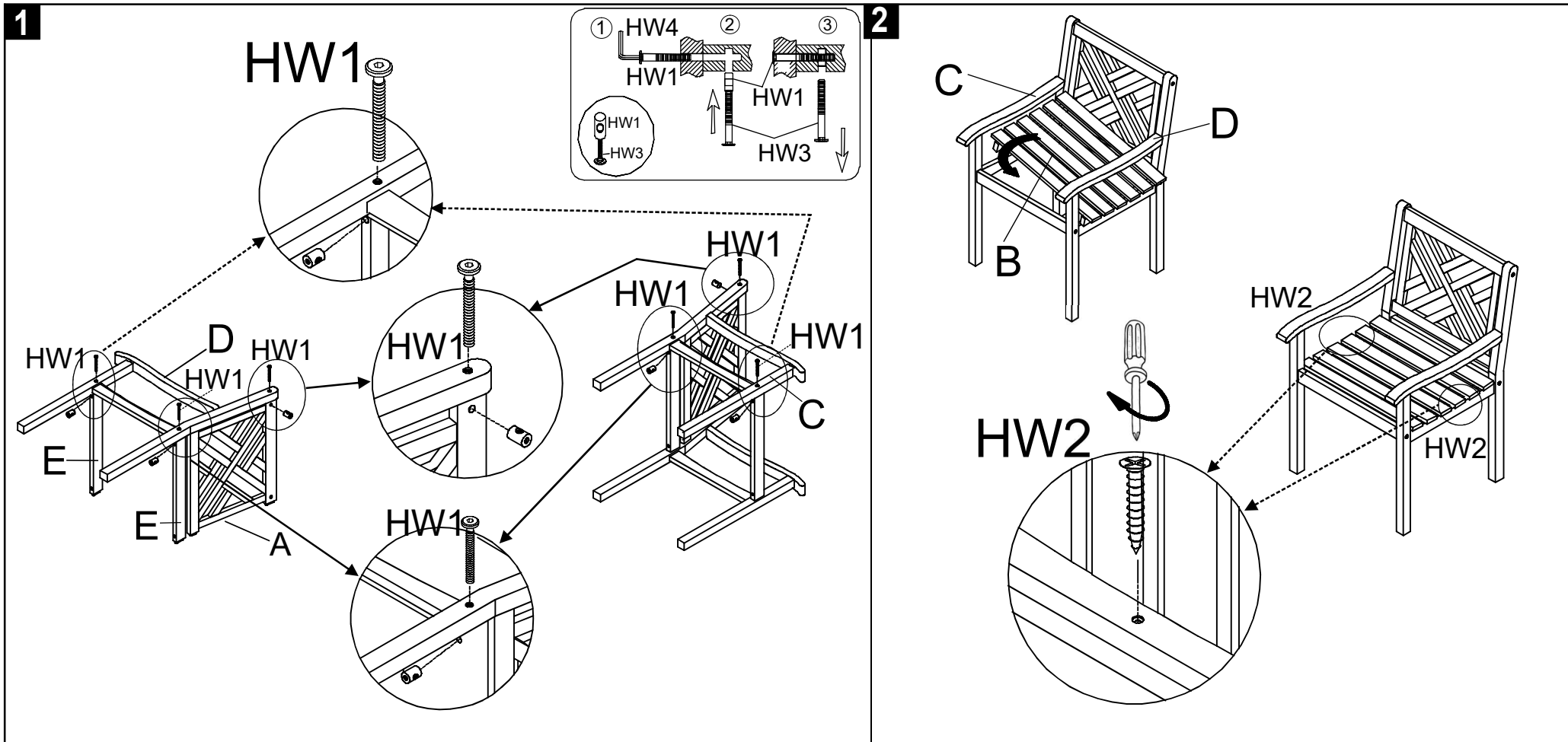

Step 1: Attach the Left side (D) to the Back (A). Then attach the Support (E) as shown on the picture by using the T bolt & nut (HW1) and tighten it by the Allen key (HW4) and Extra bolt (HW3). Continue with the Right side (C) in the same way. Make sure to tighten all before You continue with step 2.

Step 2: Put the Seat (B) inside the chair and use the Screws (HW2) to fix as shown on the picture, tighten with a screwdriver.