

edishine[®]

Wall Light

[Instruction Manual]

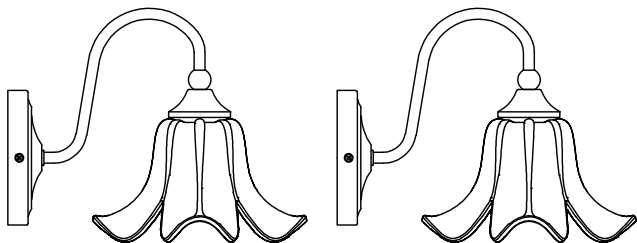

Please pay attention to the warning signs
Read the instructions with caution before operating
and keep it properly

WARNING:

Risk of fire. Min 167°F/75°C supply conductors. Consult a qualified electrician to ensure correct installation. Before installation, please turn off the main power of the circuit breaker to prevent possible electric shock.

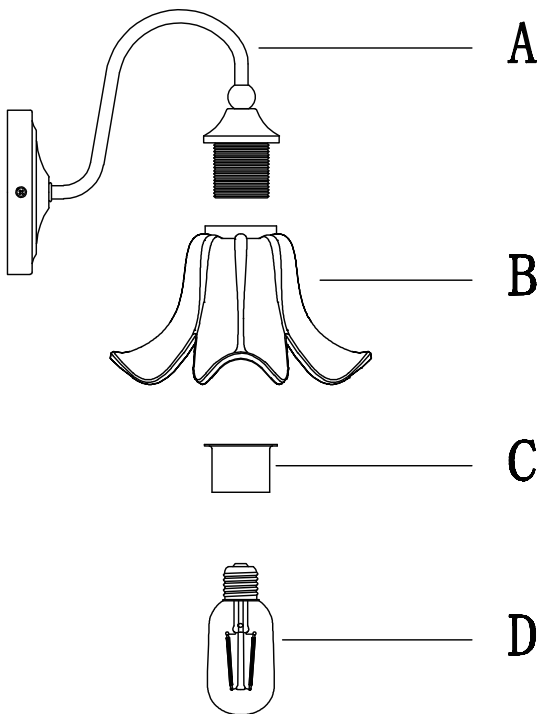

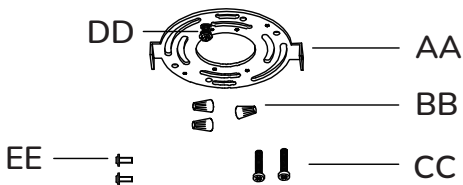

- 1.C/AA/DD/EE are pre-installed on D.
- 2.BB/CC are included as accessory packs.

Packing List

Part	Description	Quantity
A	Lamp Body	2
B	Lamp Shade	2
C	Lamp Shade Ring	2
D	Bulb	2
E	Metal Tube	2
F	Remote Control	1
AA	Hanging Plate	2
BB	Wire connector	6
CC	Mounting screw	4
DD	Grounding Screw	2
EE	Fixture mounting screw	4

Installation Instructions

FIG.1. Turn the wall switch to the "OFF" position.

Depending on which type of fuse box in your home.

FIG.2. Either turn the main (Master) switch to the "OFF" position to cut off the power supply of the entire home, or turn off the individual switch that supplies power to where the fixture will be installed.

OR

FIG.3. Either turn the main (Master) switch to the "OFF" position to cut off the power supply of the entire home, or unscrew the fuse that supplies power to where the fixture will be installed.

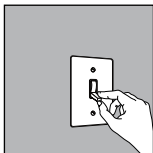

FIG.1 WALL SWITCH

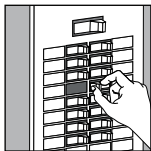

FIG.2 BREAKER PANEL

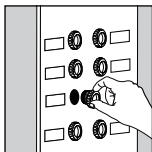
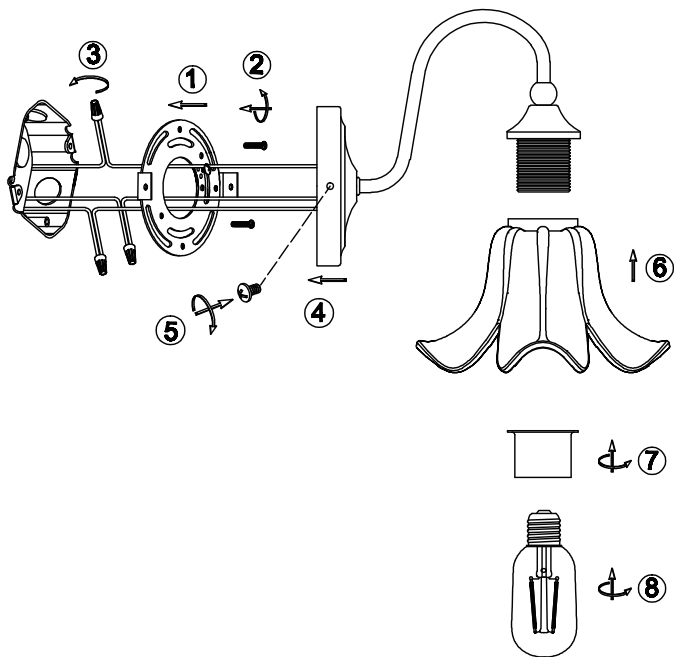

FIG.3 FUSE BOX

ASSEMBLING THE FIXTURE

- 1.Install mounting bracket onto junction box with provided Mounting screw.
- 2.Connect Ground Wire(copper wire) from the light to the ground wire from junction box by using Ground Screw onto the bracket.
Connect Black Live Wire from light to the bare end of live wire from junction box by twisting wire connector.
Connect the White Neutral Wire from the light to the bare end of neutral wire from junction box with the other wire connector.
- 3.Make sure the wire connections are secure. Tuck the wire connections neatly into the wall junction box.

Fig 1



4. Attach the fixture onto the mounting bracket, aligning the backplane holes with screw hole of the mounting bracket in side, lock it securely with the fixture mounting screw.

5. Raise the Lamp Shade to the lamp holder, then lock it securely with Lamp Shade Ring until tight.

6. Install the included light bulb.

Safety Note: Always ensure the power is turned off at the circuit breaker before beginning any electrical work.

IMPORTANT SAFETY INSTRUCTIONS

This portable lamp has a polarized plug (one blade is wider than the other) as a safety feature to reduce the risk of electric shock. This plug will fit in a polarized outlet only one way. If the plug does not fit fully in the outlet, reverse the plug. If it still does not fit, contact a qualified electrician. Never use with an extension cord unless the plug can be fully inserted. Do not alter the plug.

Specifications:

- Input Voltage: 120VAC 60Hz
- Socket Type: Standard Medium E26
- Max.Load Power: Incandescent Bulb 60W、LED Bulb 12W

One Year Limited Warranty

Supported by our professional R&D team and QC team, we provide One Year Warranty for materials and workmanship from the purchase date. Please note that the warranty does not cover damage caused by personal misuse or improper installation.

Please attach your Order ID and Name so that our dedicated customer service team can help you better.

