

# ASSEMBLY INSTRUCTIONS



5 min



2 pers

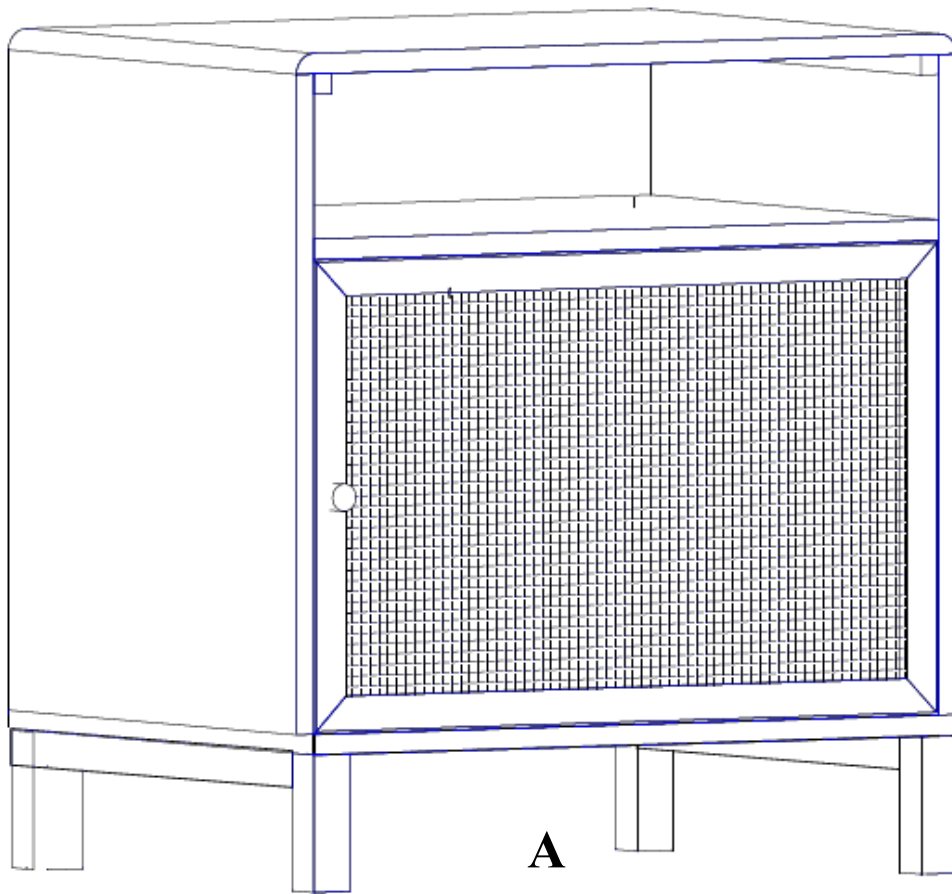

A

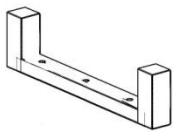

**Bx2**



**Cx1**

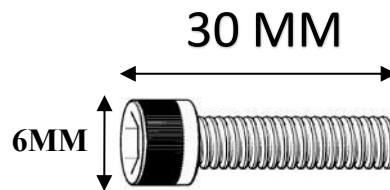

**Dx6**

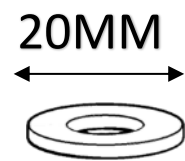

**Ex6**

1

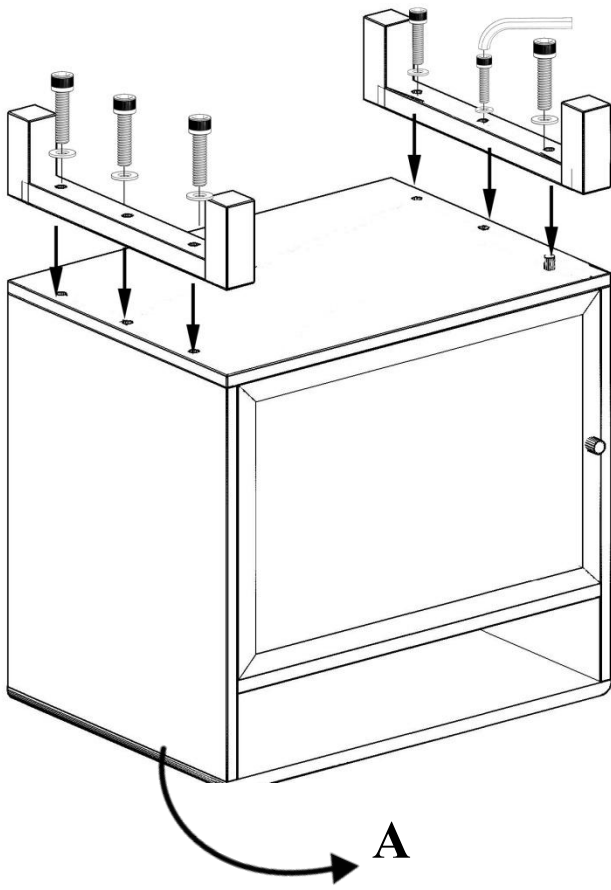

3

2

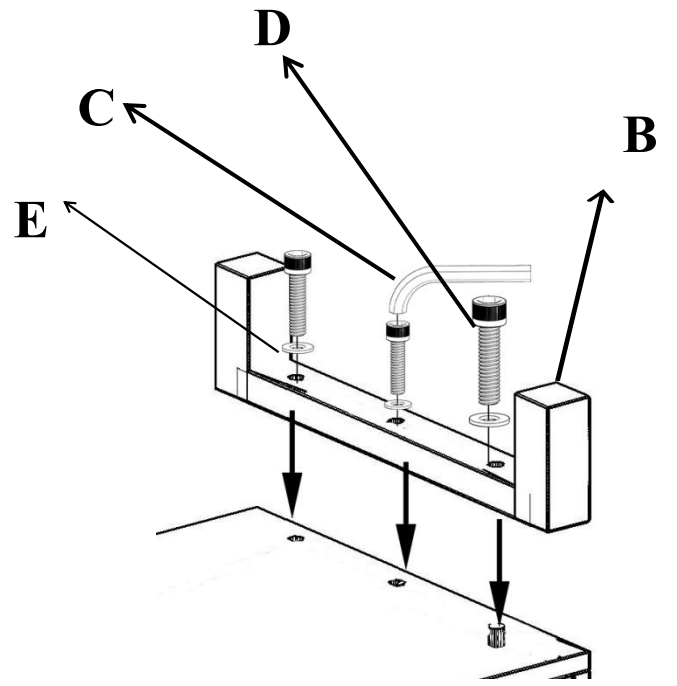

4

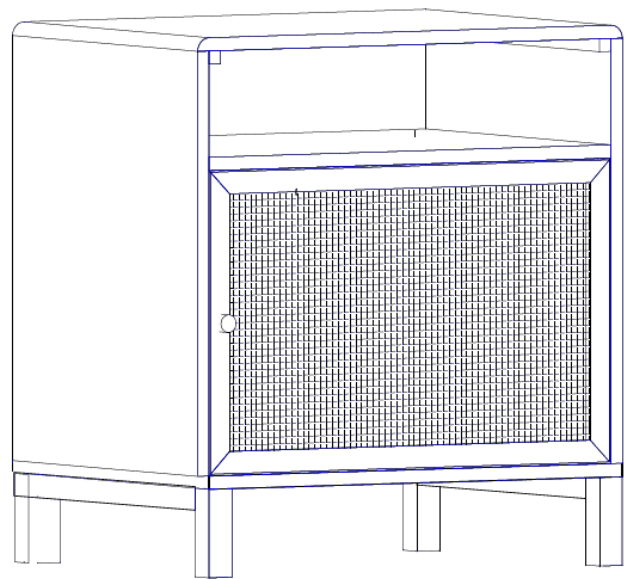
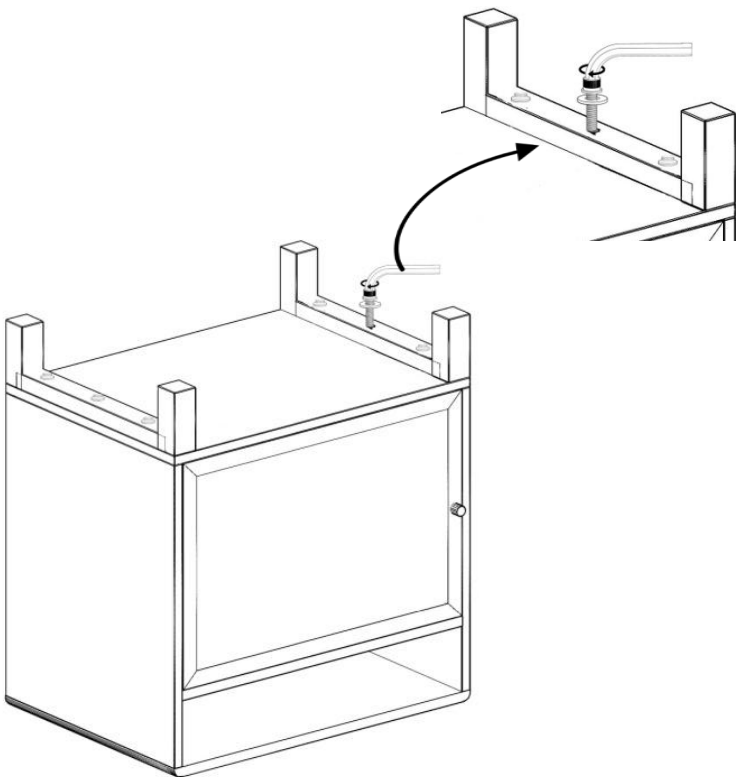

Now product is ready for use