

USER GUIDE



ELECTRIC FIREPLACE

WARNING & SAFETY

- Read this manual before installing and operating this appliance.
- Failure to follow these instructions may result in electric shock, fire property, or personal injury.
- Do not store or use gasoline or other flammable liquids in vicinity of this appliance.
- This heater is hot when in use. To avoid burns, DO NOT let bare skin touch hot surfaces. If provided, use handles when moving this heater. Keep combustible materials, such as furniture, pillows, bedding, papers, clothes, and curtains at least 3 feet (0.9m) from the front of the heater, and keep them away from the sides and rear.
- Extreme caution is necessary when any heater is used by or near children or invalids and whenever the heater is left operating and unattended.
- DO NOT operate any heater with a damaged cord or plug or after the heater malfunctions, has been dropped or damaged in any manner, discard heater, or return to authorized service facility for examination and /or repair.
- DO NOT run power cord under carpeting. DO NOT cover power cord with throw rugs, runners, or similar coverings. DO NOT route power cord under furniture or appliances. Arrange power cord away from traffic area, and where it will not be tripped over.
- DO NOT insert or allow foreign objects to enter any ventilation or exhaust openings, as this may cause electric shock or fire, or damage the heater.
- To prevent a possible fire, DO NOT block air intakes or exhaust in any manner. Doing so could cause a fire. DO NOT use on soft surfaces, like a bed, where openings may become blocked.

- A heater has hot and arcing or sparking parts inside. DO NOT use it in areas where gasoline, paint, or flammable liquids are used or stored.
- Use this heater only as described in this manual. Any other use not recommended by the manufacturer may cause fire, electric shock, or injury to persons.
- ALWAYS plug heaters directly into a wall outlet/receptacle. Never use with an extension cord or relocatable power tap (outlet/power strip).
- DO NOT place the heater near a bed because objects such as pillows or blankets can fall off the bed and be ignited by the heater.
- NEVER use this heater in bathrooms, laundry rooms, or any other location where the heater could fall into a bathtub or pool, become damp or come in contact with water.
- The heater should be installed so that the person in the bathtub or shower cannot touch the switch or other controllers.
- The heater must not be placed directly under the socket.
- AVOID FIRE! Regularly inspect all air vents to make sure they are free from dust, lint, or other Blockage. Unplug the unit and clean with a vacuum ONLY. DO NOT rinse or get wet.
- ALWAYS mount to wall bracket before use. DO NOT set on the floor, or other surface, to use.
- NEVER use a wall mount bracket from another manufacturer.
- This product is not intended to be a primary heat source. It is for supplemental heat only.
- INDOOR use only! NEVER use this heater outdoors! Doing so may result in electric shock!
- Risk of electric shock! DO NOT OPEN! No user-serviceable parts inside !
- ALWAYS turn this heater off before unplugging it from the outlet.

- ALWAYS disconnect this unit from the power supply before performing any assembly or cleaning, or before relocating the electric fireplace.
- NEVER leave this heater unattended. ALWAYS unplug this heater when not in use.
- ALWAYS store this heater in a dry location. NEVER use the fireplace if it has become wet.
- NEVER plug this heater into an outlet that is old, cracked, or has any loose wires or connections. Plugging this heater into a faulty outlet could result in electric arcing within the outlet that could cause the outlet to overheat or catch fire.
- ALWAYS check your heater cord and plug connections with each use!
- MAKE SURE the plug fits tight in the outlet! Faulty wall outlet connections or loose plugs can cause the outlet to overheat.
- Heaters draw more current than small appliances. Overheating may occur even if it has not occurred with the use of other appliances.
- During use check frequently to see if the plug outlet or face plate is HOT!
- This appliance is not intended for use by persons (including children) with reduced physical, sensory or mental capabilities, or lack of experience and knowledge, unless they have been given supervision or instruction concerning use of the appliance by a person responsible for their safety. Children should be supervised to ensure that they do not play with the appliance.
- If the supply cord is damaged, it must be replaced by the manufacturer, its service agent or similarly qualified persons in order to avoid a hazard.
- Children shall not play with the appliance!
- Cleaning and user maintenance shall not be made by children without supervision!

PREPARATION

This product includes a GLASS panel! Always use extreme caution when handling glass. Failure to do so could result in personal injury or property damage.

Remove all parts and hardware from the carton and place them on a clean, soft, dry surface. Parts and assembly steps are grounded for wall-hanging or recessing use. Check the parts list to make sure nothing is missing. Dispose of packaging materials properly. Please recycle whenever possible. You will need the following tools (not included): Phillips screwdriver; stud finder; level; tape measure; electric drill; 1/4" wood drill bit, hammer.

COMPONENT

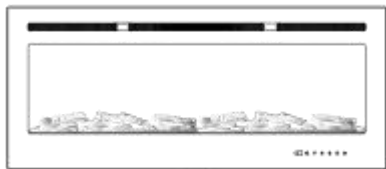

A: Fireplace



B: Wood Screws



C: Drywall Anchors

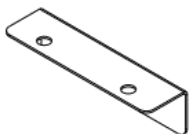

D: Metal Bracket



E: Wall Bracket
Fixed on Back of Firebox



F: Decorative
Crystals



G: Decorative
Pebbles



H: Log Set



I: Plastic Tray



Remote Control

DIMENSION

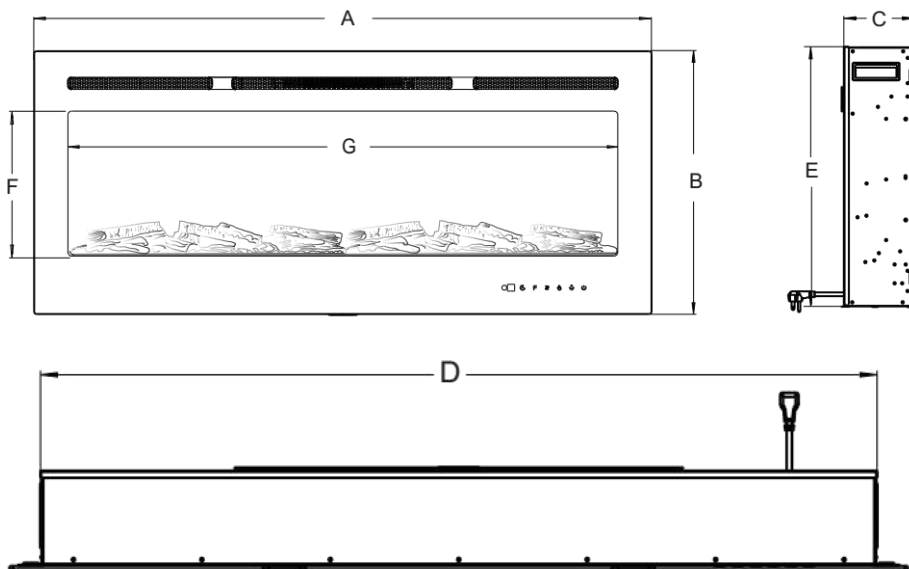

Product Dimensions

Model Number	A	B	C	D	E	F	G
IF-1350	50.3" 128.0cm	21.42" 54.4cm	5.51" 14.0cm	46.93" 119.2cm	21.31" 54.12cm	11.81" 30.0cm	44.88" 114.0cm

INSTALLATION

- Your appliance is a wall-mounted, recessed and /or mantel installed appliance. Select a suitable location that is not susceptible to moisture and is away from drapes, furniture and high traffic areas.
- NOTE: Follow all National and local electrical codes.

Minimum Clearance to Combustibles

Measurements are taken from the glass front.			
Bottom	0"	Top	8" (300mm) to mantel
Sides	0"	Top	8" (300mm) to ceiling
Back	0"		

Minimum Mantel Clearances

Warning: When using paint or lacquer to finish the mantel, the paint or lacquer must be heat resistant to prevent discoloration.

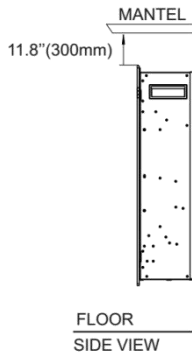

Recessed to Wall Installation

STEP 1: Select a dry wall to open a hole for fireplace box. Size of hole as below chat. **Figure (A)**

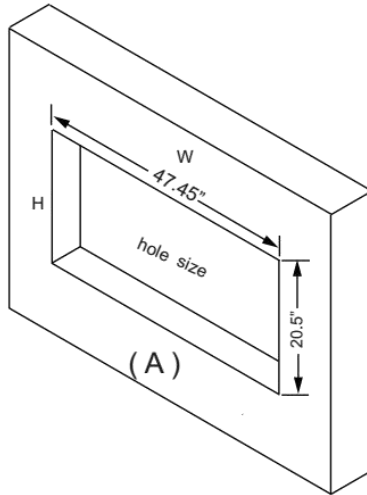

STEP 2 : Fix the three wall anchors in each side of the fireplace box according to the dimensions. Showed on the drawing. **Figure (B)**

Framing Hole Size		
Model Number	W	H
IF-1350	47.44" (120.5cm)	20.5" (52.1cm)

STEP 3: Take off the two screws in both sides of fireplace. **Figure (C)**

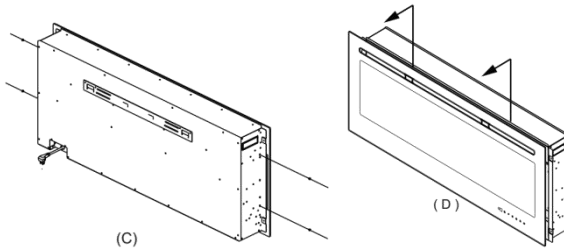

STEP 4: Have two persons to take the glass panel out of the fireplace box. Place it to a soft and clean place. **Figure (D)**

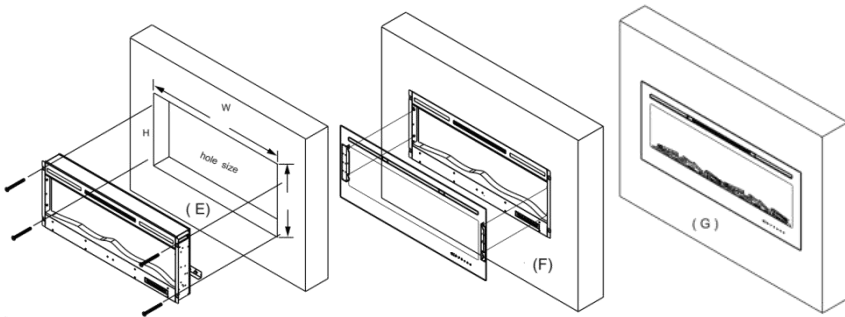

STEP 5: Have two persons to move the fireplace box to the wall hole.

If the appliance is fully recessed into the wall:

- Use the 4 screws (provided) to lock the appliance into wall with the existing two side flanges, **see Figure(E)**
- Install the media and re-install the glass front.

STEP 6: Place the front panel lock the appliance. **Figure (F)**

STEP 7: Fireplace will be like this after installation. **Figure (G)**

Wall Mounted Installation

- Due to many different materials used on different walls, it is highly recommended that you consult your local builder before you install this appliance on the wall.
- Select a location that is not prone to moisture and is located at least 36" (914mm) away from combustible materials such as curtain drapes, furniture, bedding, paper, etc.
- Have two people hold the appliance against the wall to determine the final location.
- Place unit face down on a soft, non abrasive surface. Remove the bracket from the back of the unit by removing the screws, refer to Figure 1.
- Mark out location, then mount the bracket(s) onto the wall using the supplied screws. This bracket **MUST** have the hooks facing upward and be level.

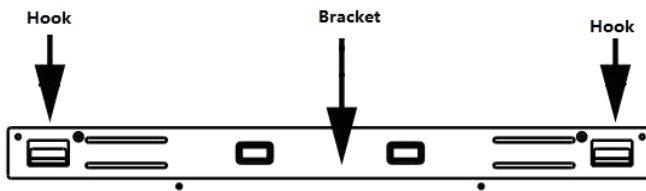

- NOTE: It is strongly recommended that the mounting bracket(E) be screwed into the wall studs where possible. If the wall studs cannot be used, ensure that the supplied plastic anchors are used to affix the bracket to the wall and the bracket is adequately secured.
- Fasten the metal bracket at the back of fireplace with 1pc 4x8mm screw, the other end to the wall with 2pcs of Drywall anchors.
- With the wall mounting bracket installed have two people lift the appliance up and insert the two hooks on the bracket into the two slots on the back of the appliance.

- Check the appliance for stability ensuring that the bracket will not pull free from the wall.

Fig.1

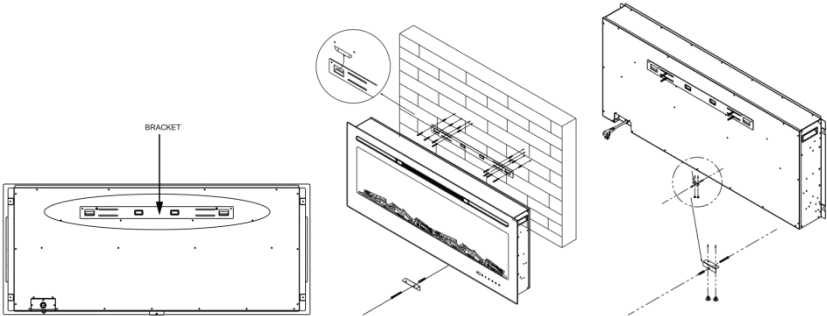
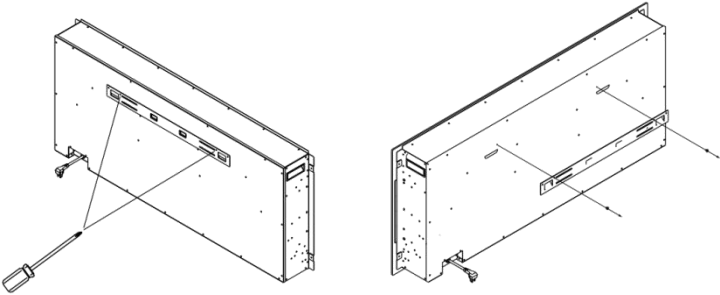

Fig.2



Log set /Crystal/Pebble Ember Installation

(Note: Please make the installation according to the embers which you bought or selected.)

A. Glass front must be removed and the appliance must be mounted in its final location before the log set/crystal/pebble embers are installed.

B. If your fireplace come with log set, remove the log set from the package, put it to the fireplace designed place.

Figure 1.

C. If your fireplace come with CLEAN CRYSTAL or PEBBLE MEDIA: crystal or pebbles media may have a fine oil residue that needs to be cleaned prior to installation. Clean them with mild dish soap, drain, rinse thoroughly and dry before placing into the tray.

D. Place the plastic tray(l) to the fireplace designed place. Then carefully place crystal or pebbles embers into the bottom tray on the front of the appliance as illustrated. Apply an even layer from side to side. Figure 2, Figure 3.

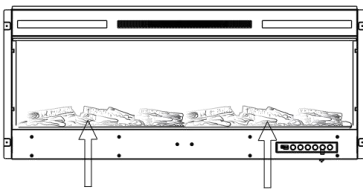

figure 1.

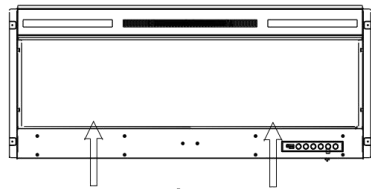
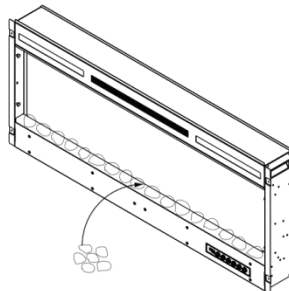
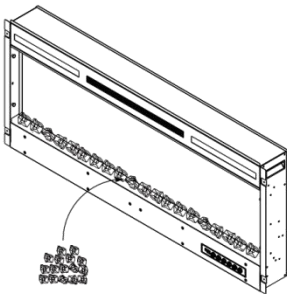

figure 2



Warning

- Read and understand this entire owner’s manual, including all safety information, before plugging in or using this product. Failure to do so could result in electric shock, fire, serious injury, or death.

Power

- Plug the power cord into a 220 Volt 7 Amp grounded outlet. Make sure the outlet is in good condition and that the plug is not loose. NEVER exceed the maximum amperage for the circuit. DO NOT plug other appliances into the same circuit.

Methods of Operation

- This electric fireplace can be operated by the TOUCH PANEL, located on the BOTTOM right side glass panel of the fireplace, or by the battery-powered.





Remote Control

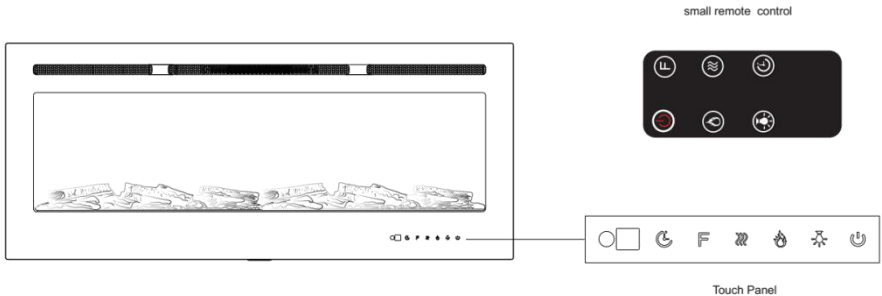

- The operation and functions of the two methods are the same.

Before operating, please review the IMPORTANT SAFETY INFORMATION on Pages 2 and 3, and heed all warnings.



OPERATION

BUTTON	FUNCTION	ACTION&INDICATION
 POWER	<p>ON: Enables control panel functions and remote control. Turn on flame effect.</p> <p>OFF: Disables control panel functions and remote control. Turn off flame effect.</p>	<ol style="list-style-type: none"> 1. Press once. Indicator light turns on. Power turns on. All functions enabled. 2. Press.
 COLOR	<p>COLOR button: Makes the color flame effect change.</p>	<ol style="list-style-type: none"> 1. Press once. Flame color effect gets changed. 2. Press again until desired setting is reached.
 FLAME	<p>FLAME button: Makes flame effect dimmer and brighter.</p> <p>NOTE: Flame effect stays on until power button is turned off. Flame effect must be on for heater to turn on.</p>	<ol style="list-style-type: none"> 1. Press once. Flame brightness effect gets changed. 2. Press again. Until desired setting is reached.
 HEATER	<p>HEATER button: Turn heater on and off.</p> <p>NOTE: To prevent overheating, the heater fan will blow out cool air for 30 seconds after the heater turn off.</p>	<ol style="list-style-type: none"> 1. Press once. Indicator lights up. 900W heater turns on and blows warm air. 2. Press again. Indicator lights up. 1800W heaters turns on and blows hot air. 3. Press again. Heaters turn off. The fan blows cool air for 30 seconds to allow heater to cool down, then turns off.

	<p>TEMPERATURE button: Control temperature settings to choose temperature as desired. Setting range from 62F to 82F.</p>	<ol style="list-style-type: none"> 1. Press once. Indicator light turn on. Temperature is set to 62F. 2. Press again until desired setting is reached. LED display show setting.
	<p>TIMER button: Control timer settings to turn off fireplace at selected time. Settings range from 1 hours to 8 hours.</p>	<ol style="list-style-type: none"> 3. Press once. Indicator light turn on. Temperature is set to hours. Press again until desired setting is reached. LED display shows setting.

NOTICE

When the heater is first turned on, a slight odor may be present. This is normal and should not occur again unless the heater is not used for a long period of time. To improve operation, aim the remote control at the front of the fireplace. **DO NOT** press the buttons too quickly. Give the unit time to respond to each command.

Temperature Limiting Control

This heater is equipped with a Temperature Limiting Control. Should the heater reach an unsafe temperature, the heater will automatically turn OFF. To reset:

1. Unplug the power cord from the outlet.
2. Turn the ON/OFF switch on the CONTROL PANEL to OFF. Wait 5 minutes.
3. Inspect the fireplace to make sure no vents are blocked, or clogged with dust or lint. If they are, use a vacuum to clean the vent areas.
4. With the POWER switch in the OFF position, plug the power cord back into the outlet.
5. If the problem continues, have your outlet and wiring inspected by a professional.

Remote Control Battery Information

Small remote control uses one CR2025 battery(included).

NOTE:

Remote control battery used depends on the remote control type which is selected above.

NEVER dispose of batteries in fire. Failure to observe this precaution may result in an explosion. Dispose of batteries at your local hazardous material processing center.