

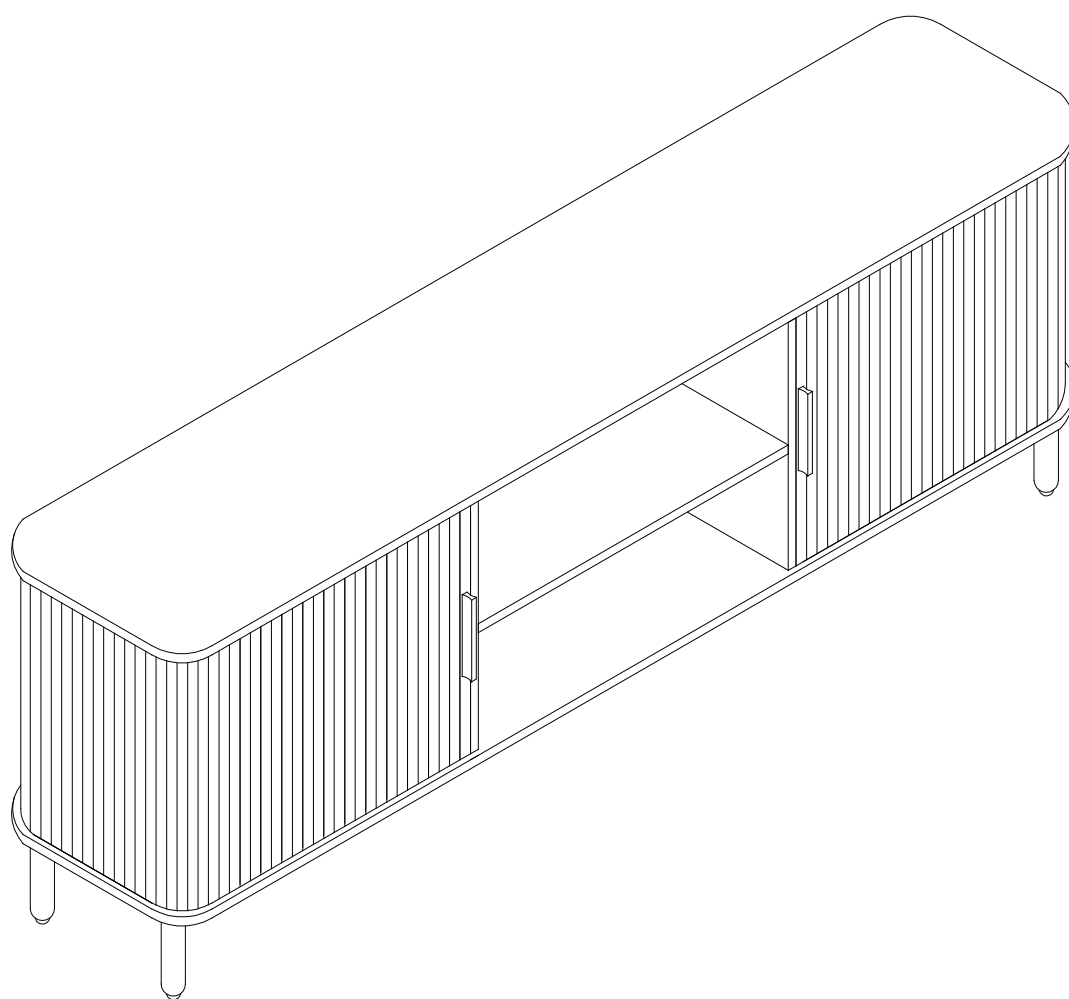

ASSEMBLY INSTRUCTIONS

WYTJHM015WH-UK





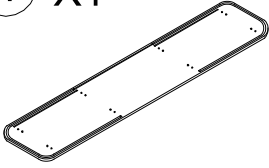
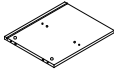
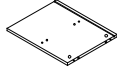
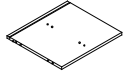
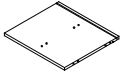
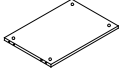
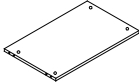
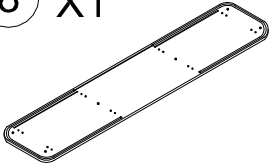
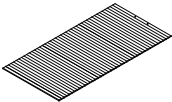

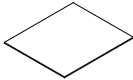
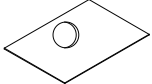

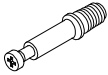

ASSEMBLY INSTRUCTIONS

Hardware List

<p>① X1</p> 	<p>② X1</p> 	<p>③ X1</p> 	<p>④ X1</p> 
<p>⑤ X1</p> 	<p>⑥ X2</p> 	<p>⑦ X1</p> 	<p>⑧ X1</p> 
<p>⑨ X2</p> 	<p>⑩ X6</p> 	<p>⑪ X2</p> 	<p>⑫ X1</p> 

Parts List

<p>Ⓐ X20</p> 	<p>Ⓑ X20</p> 	<p>Ⓒ X28</p>  <p>8*30mm</p>	<p>Ⓓ X4</p>  <p>4*8mm</p>
<p>Ⓔ X2</p> 	<p>Ⓕ X6</p>  <p>6*30mm</p>	<p>Ⓖ X1</p> 	<p>Ⓗ X8</p> 
<p>Ⓘ X6</p> 			

ASSEMBLY INSTRUCTIONS

Part List Assembly Overview

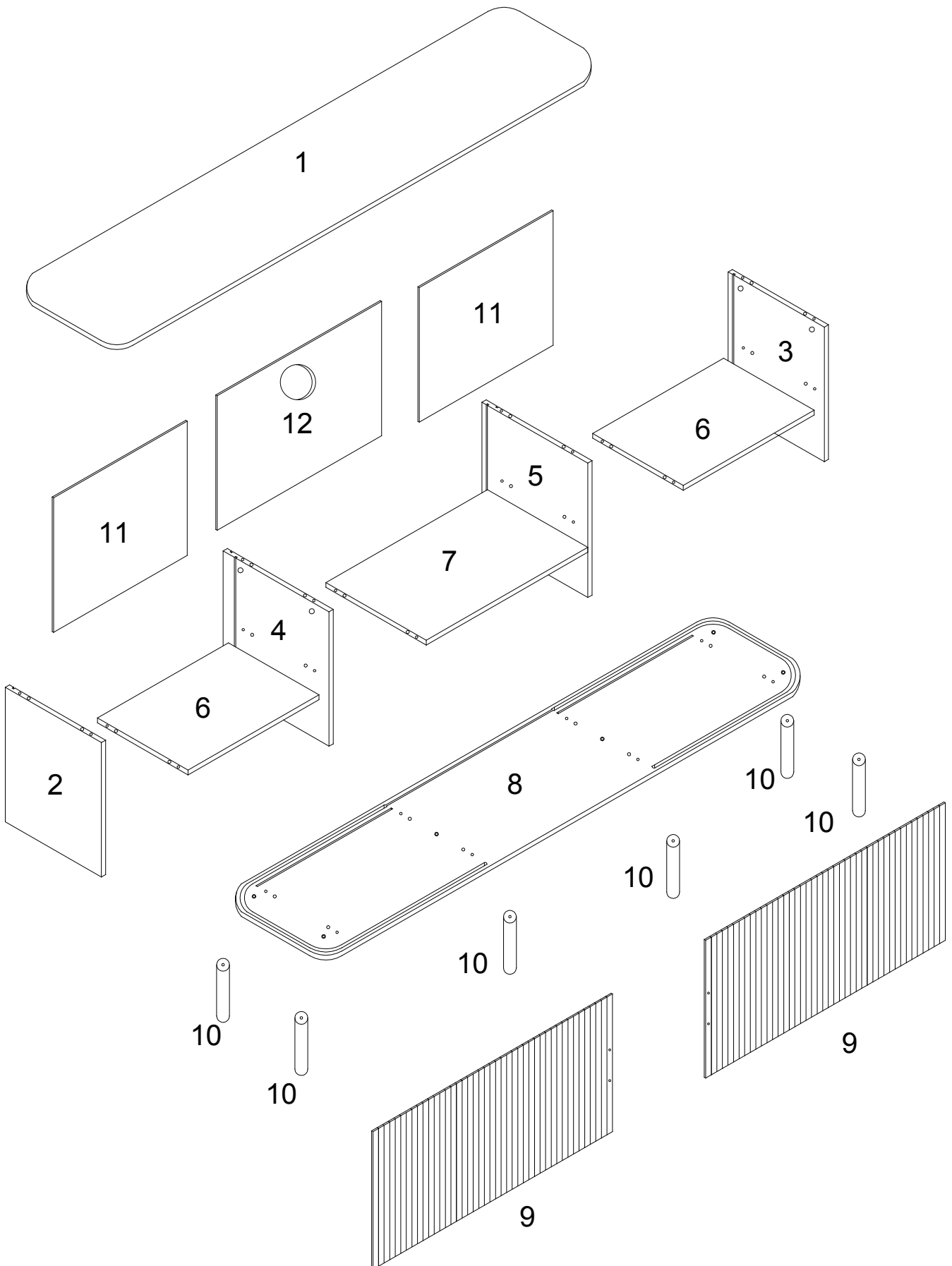

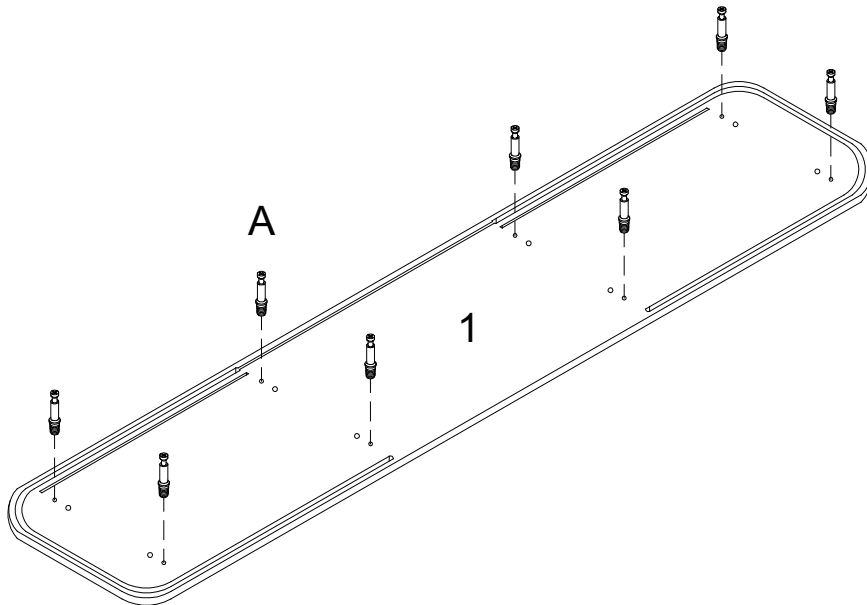
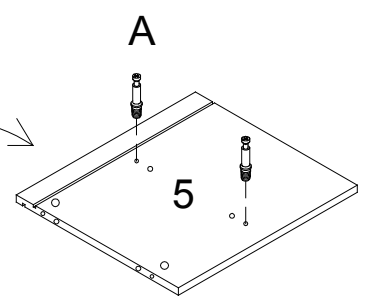
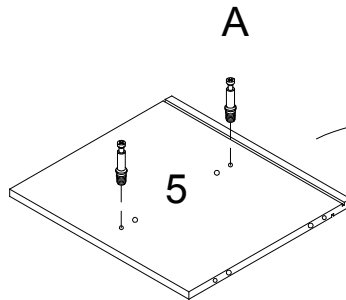
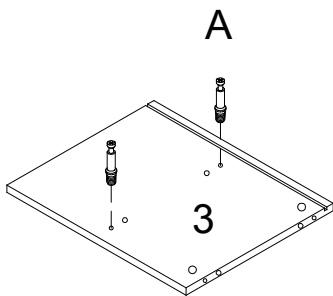
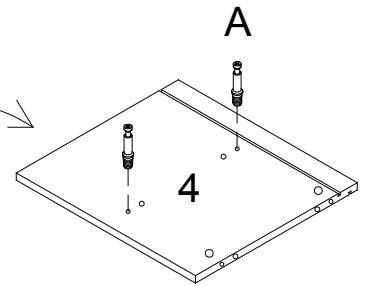
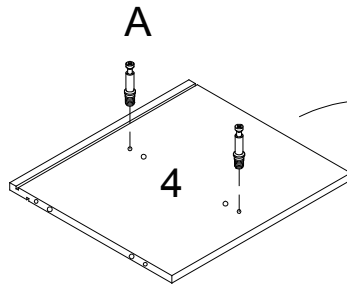
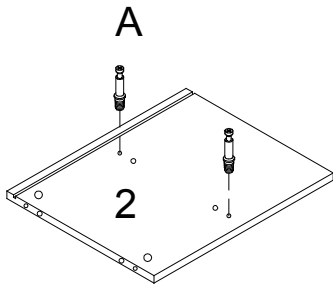

Step.1

A  X 20



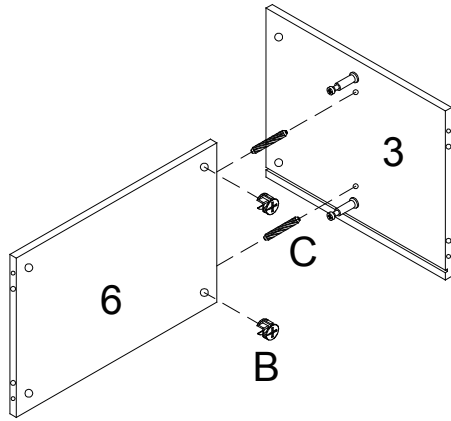

Step.2

B		X 2
C		X 2



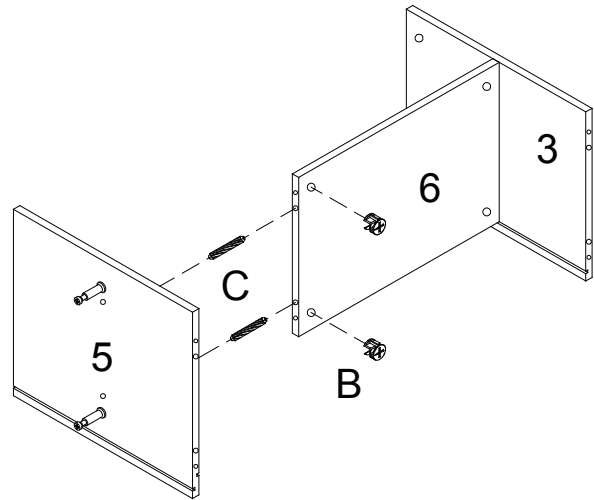

Step.3

B		X 2
C		X 2



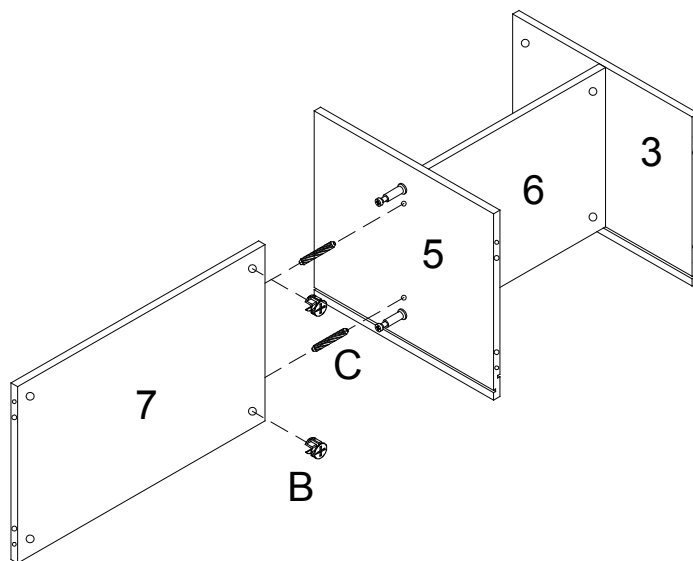

Step.4

B		X 2
C		X 2



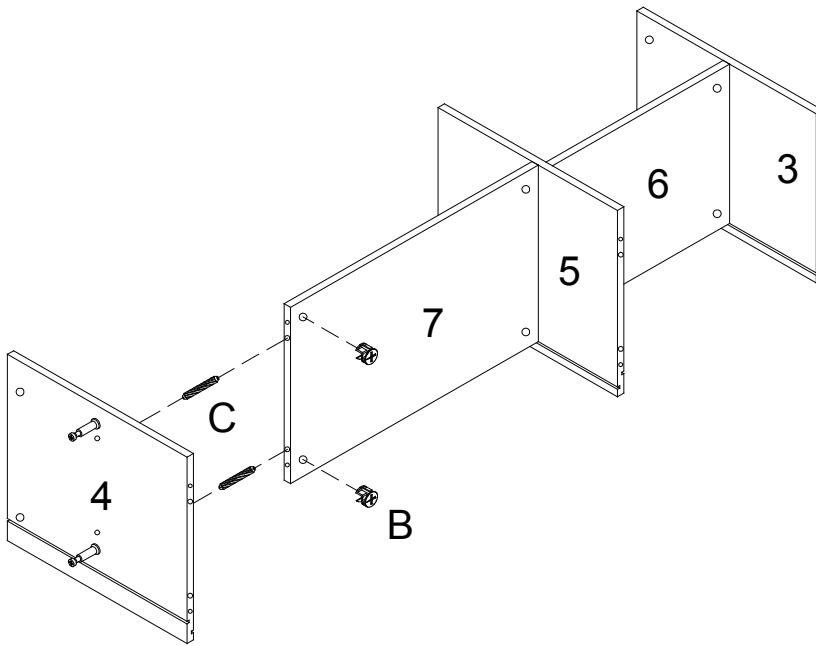

Step.5

B		X 2
C		X 2



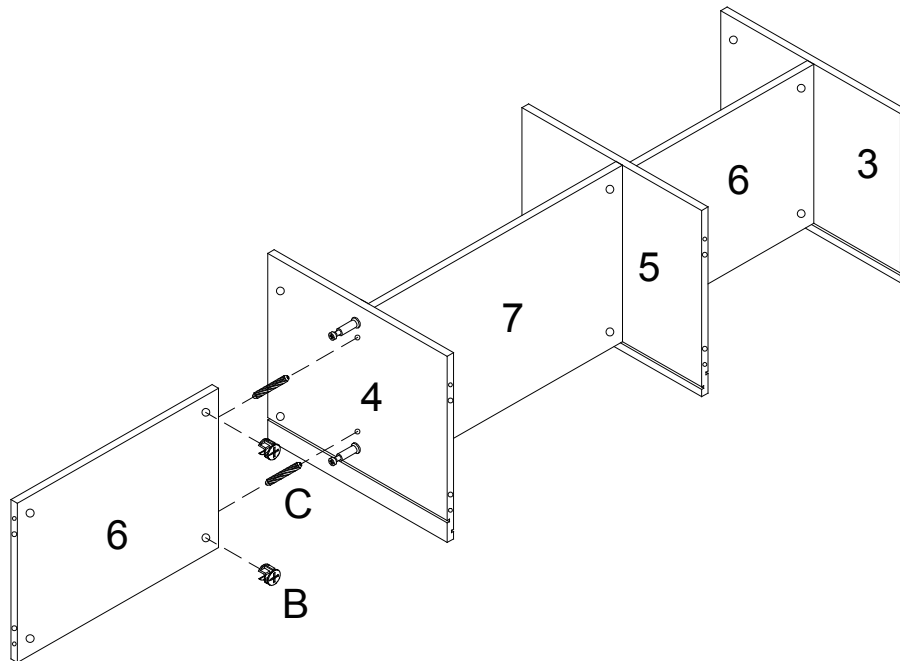

Step.6

B		X 2
C		X 2



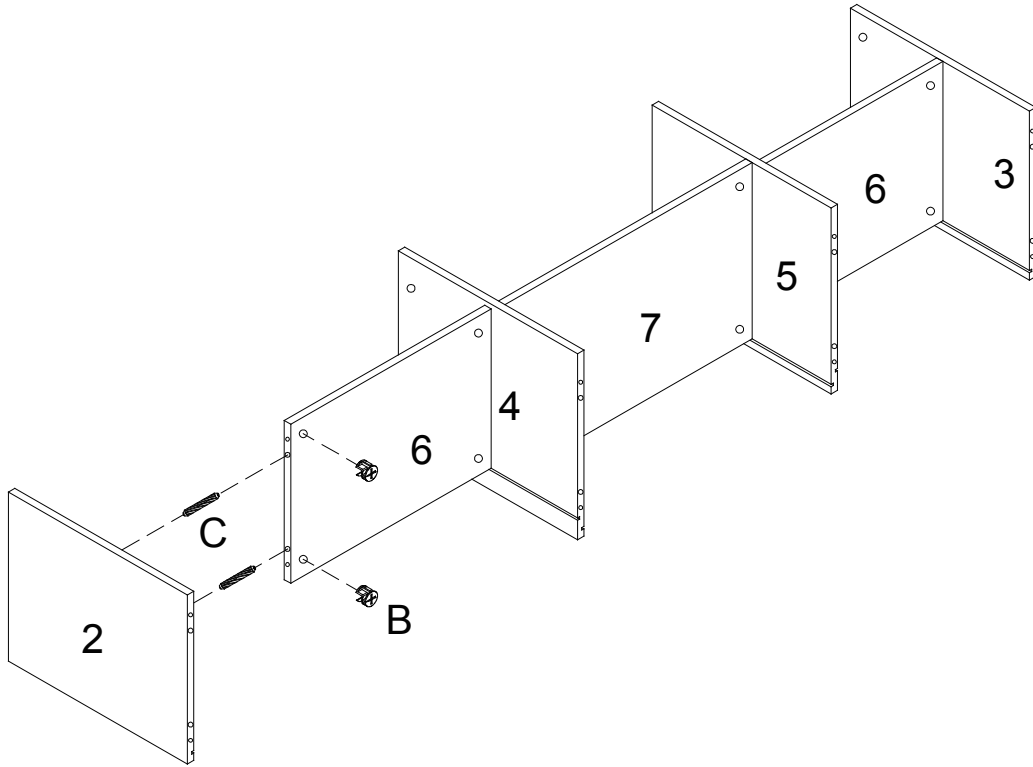

Step.7

B		X 2
C		X 2



Step.8

F		X 6
G		X 1

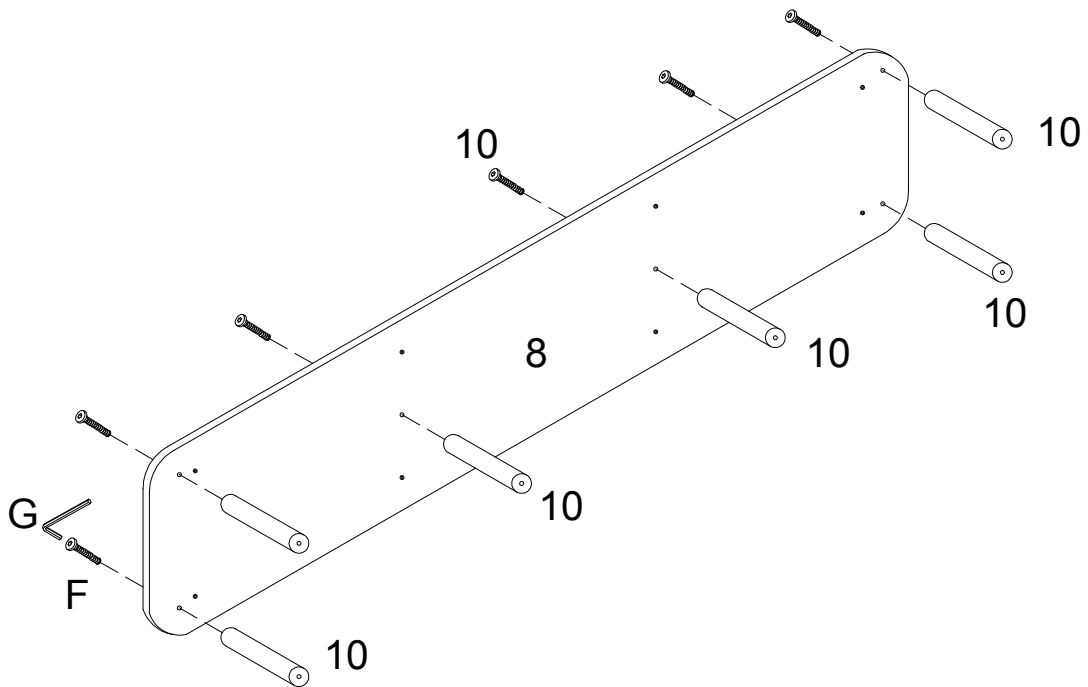

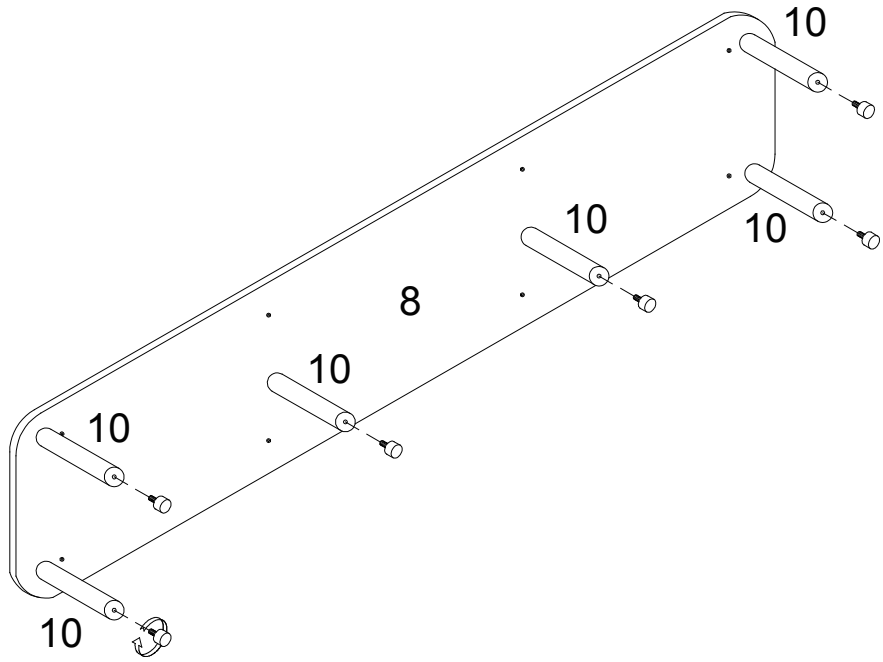

Step.9

I		X 6
---	---	-----



Step.10

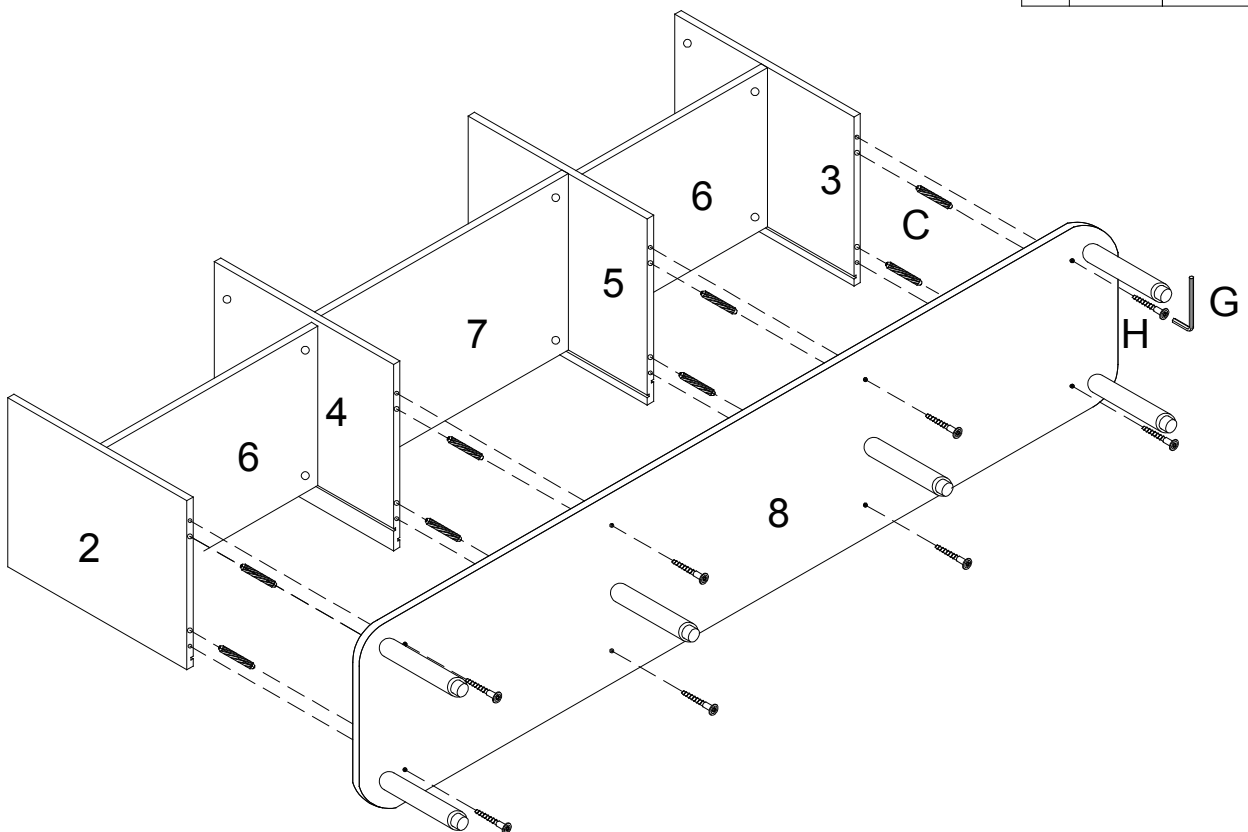

C		X 8
H		X 8

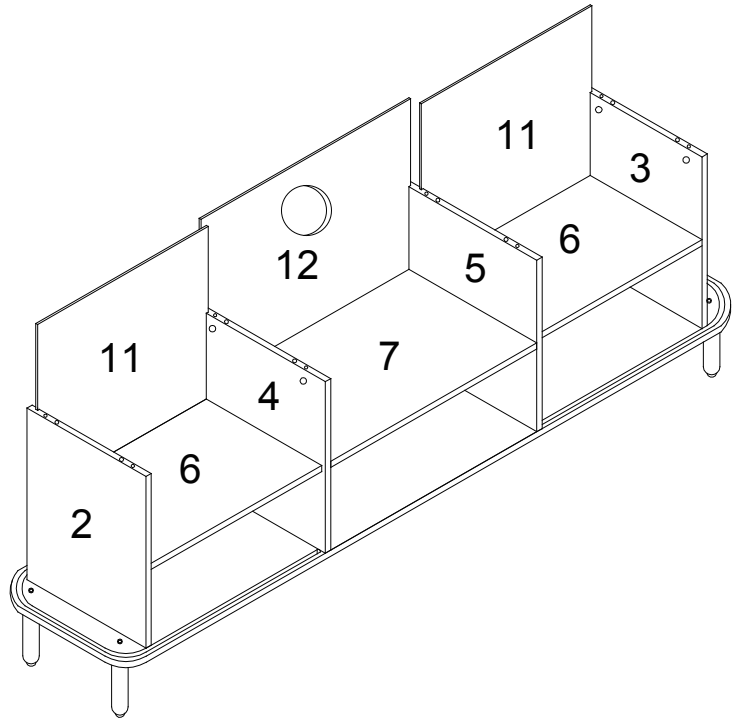

Step.11



Step.12

D		X 4
E		X 2

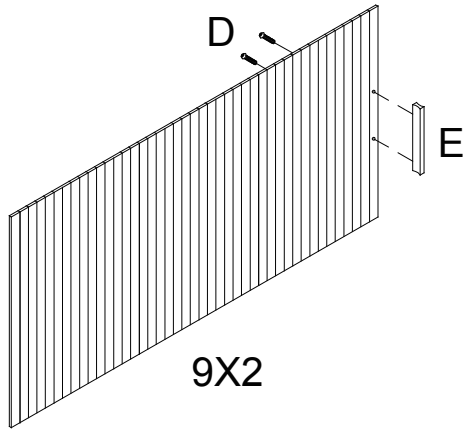

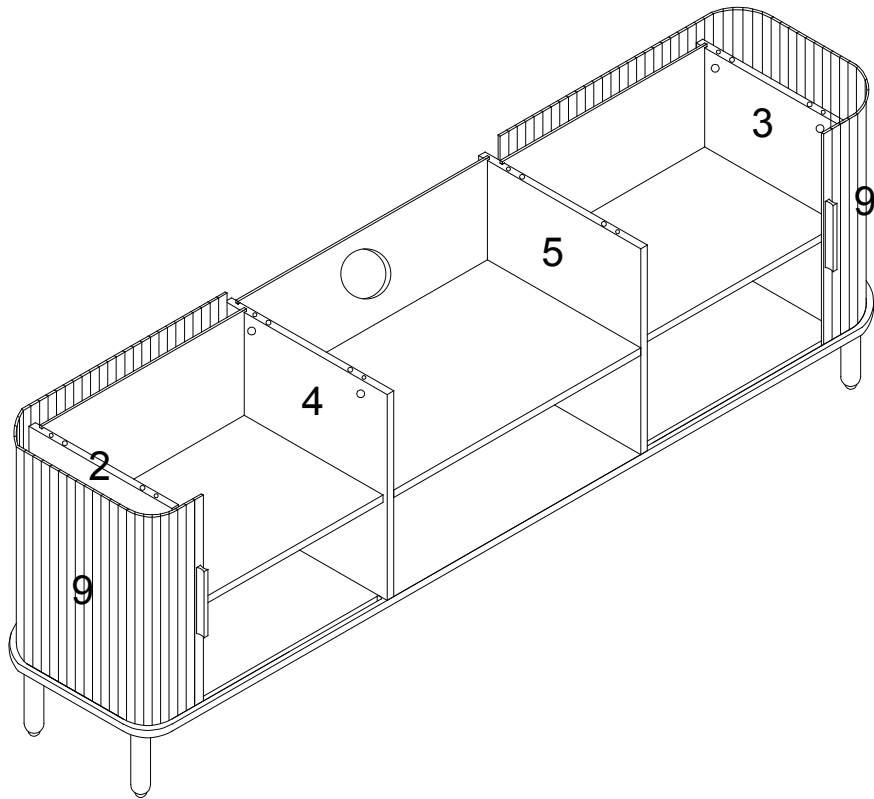

Step.13

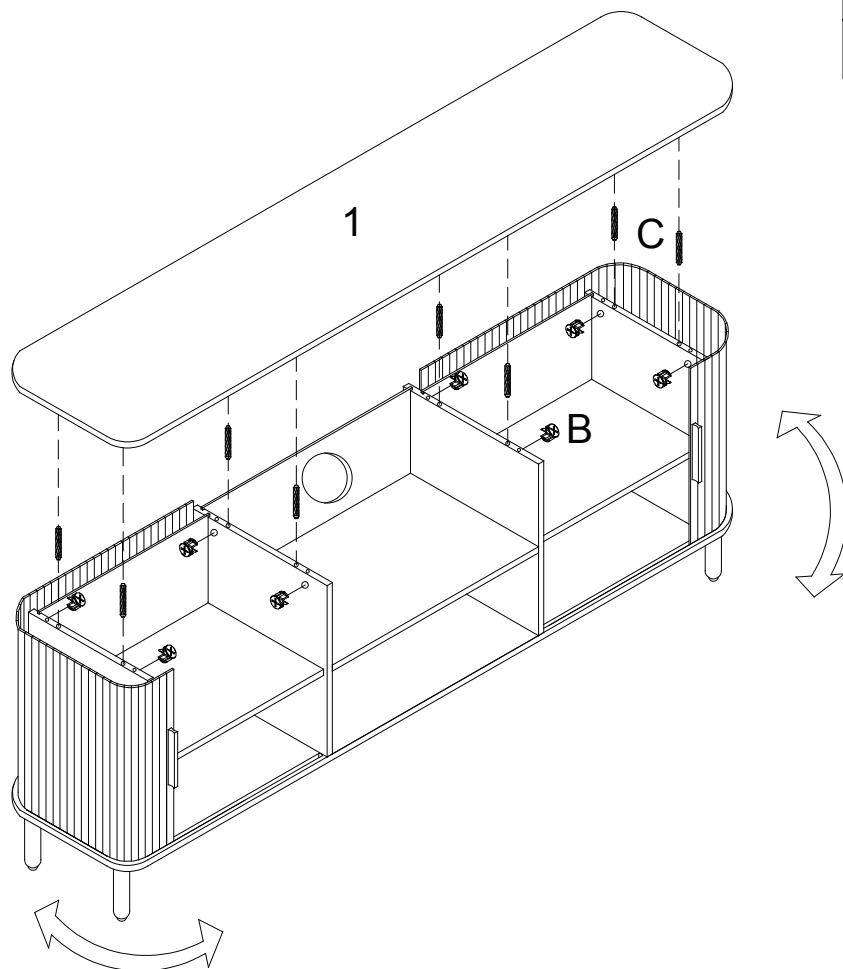

Step.14



B		X 8
C		X 8

Step.15

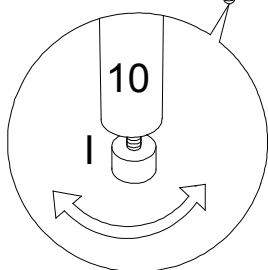
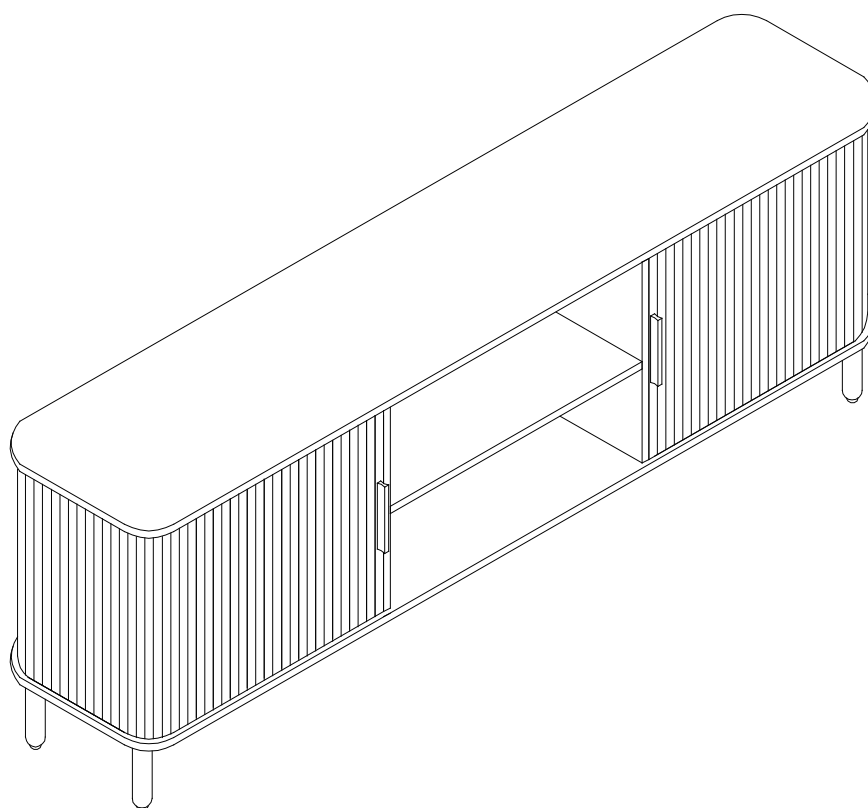

Installation completed

