

Installation instruction

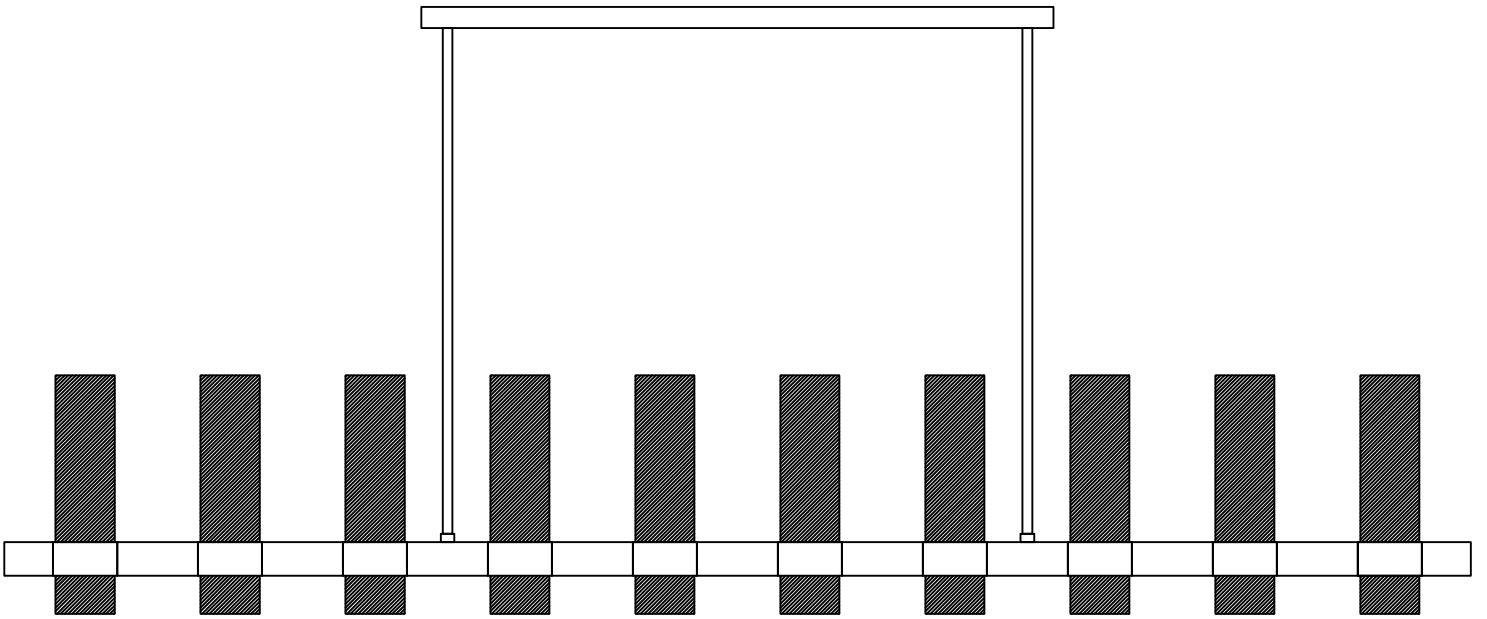

Chandelier Installation and Safety Standards

The installation of a chandelier is a crucial step in ensuring its safety. Chandelier safety standards dictate the process of installation, including the tools and equipment that can be used, the methods of securing the chandelier, and the location of the chandelier.

Securing the chandelier is a crucial step in the installation process. Chandelier safety standards dictate that the chandelier must be securely attached to a suitable support, such as a ceiling joist, to prevent it from falling. This includes ensuring that the support is strong enough to bear the weight of the chandelier, and that the chandelier is properly balanced to prevent it from tipping or swaying.

Furthermore, the chandelier must be secured using suitable hardware, such as screws or bolts, that are strong enough to bear its weight. The hardware must be properly installed and tightened to ensure that the chandelier is securely attached. Regular inspections of the hardware are also necessary to detect and repair any damage or wear promptly.

Packaging diagram:

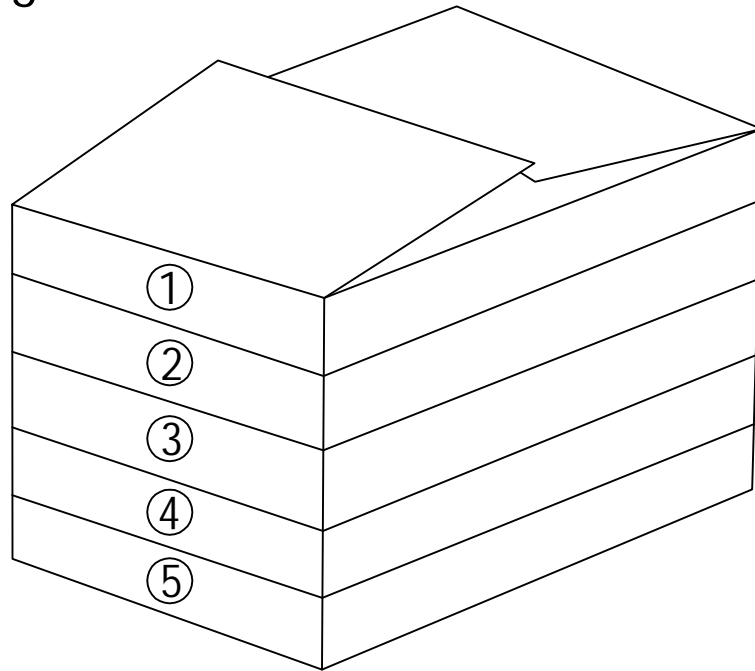

①

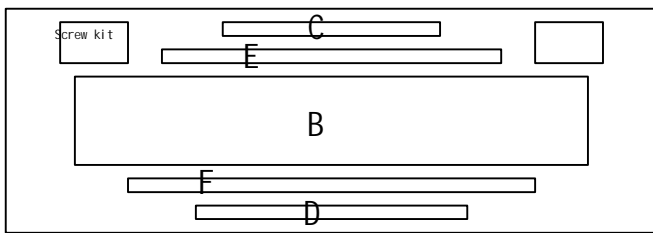

②

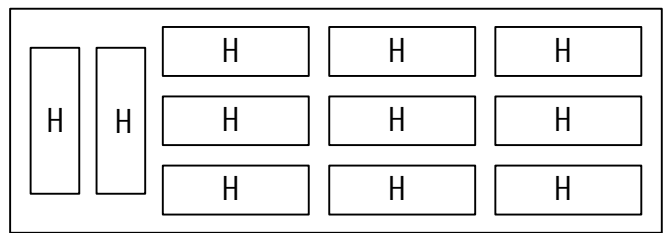

③

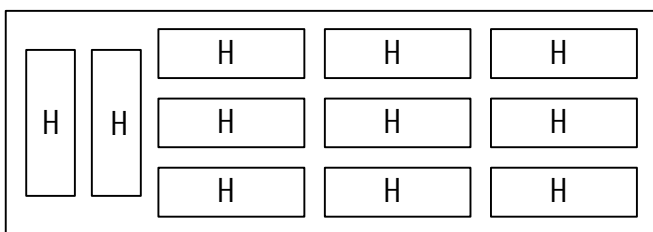

④

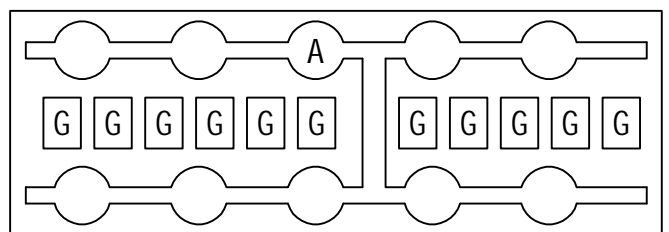

⑤

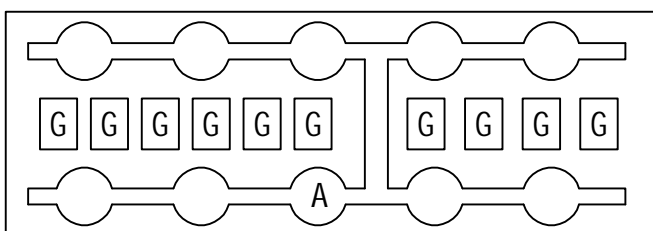

Internal packaging list:

1. First layer ceiling plate + round tube + accessory kit
2. Second layer glass shade
3. Third layer glass shade
4. Fourth layer lamp stand + glass shade
5. Fifth layer lamp stand + glass shade

Before assembly:

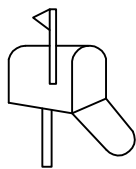

If you have any questions,
please feel free to contact us.
Wishing you a pleasant day!

★ Please read all the instructions carefully



5-star rating

★ Keep the instruction manual for future reference.

Thank you

★ Separate and inventory all parts and hardware



★ Read each step carefully and follow the correct installation sequence

★ To avoid losing any parts during assembly, we recommend not moving the lamp before completing the assembly. Always place the product on a flat, firm, and stable surface

★ Keep all small parts and packaging materials of this product away from babies and children, as they may cause serious injury

Accessory list

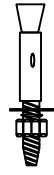

4pcs



2+2pcs

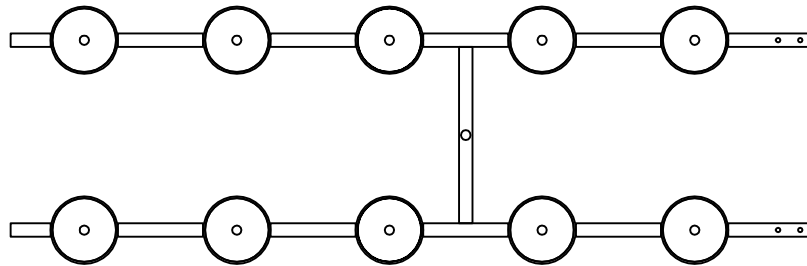

A. main lamp stand-2pcs

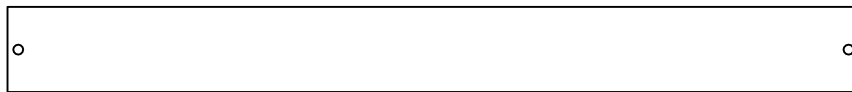

B. canopy-1pcs

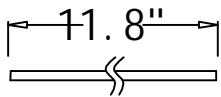

C. Tension rod
round tube-2pcs

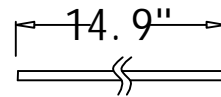

D. Tension rod
round tube-2pcs

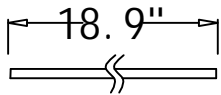

E. Tension rod
round tube-2pcs

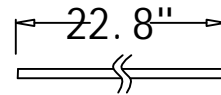

F. Tension rod
round tube-2pcs



G. Glass Shade-20+1pcs

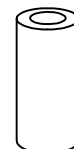

H. Glass shade-20+2pcs

①Lamp body assembly:

- (1) Find the light fixture from the sorting list.
- (2) Assemble the A light fixture according to the diagram and connect the assembled plug.
- (3) Take out the pull rod round tube and thread the power cord through the tube (as shown below).
- (4) Use screws to attach the light fixture to the ceiling plate and insert the power cord into the ceiling plate.

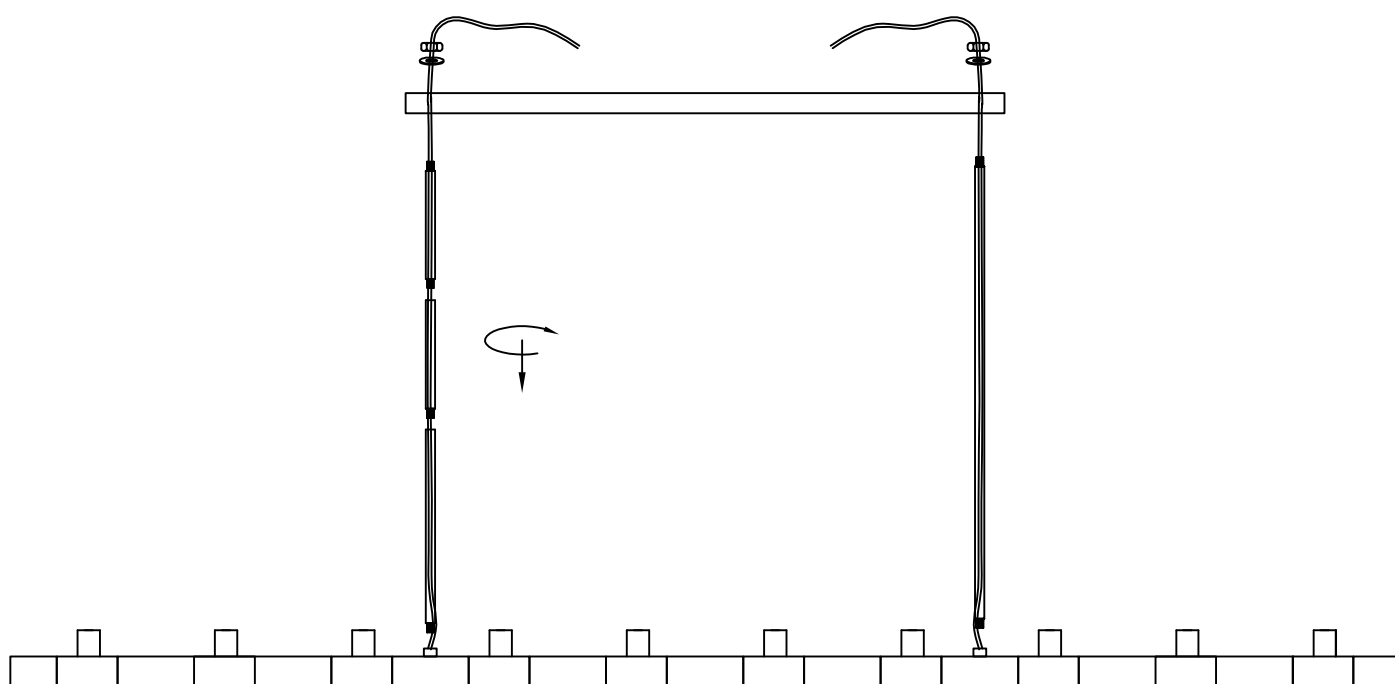
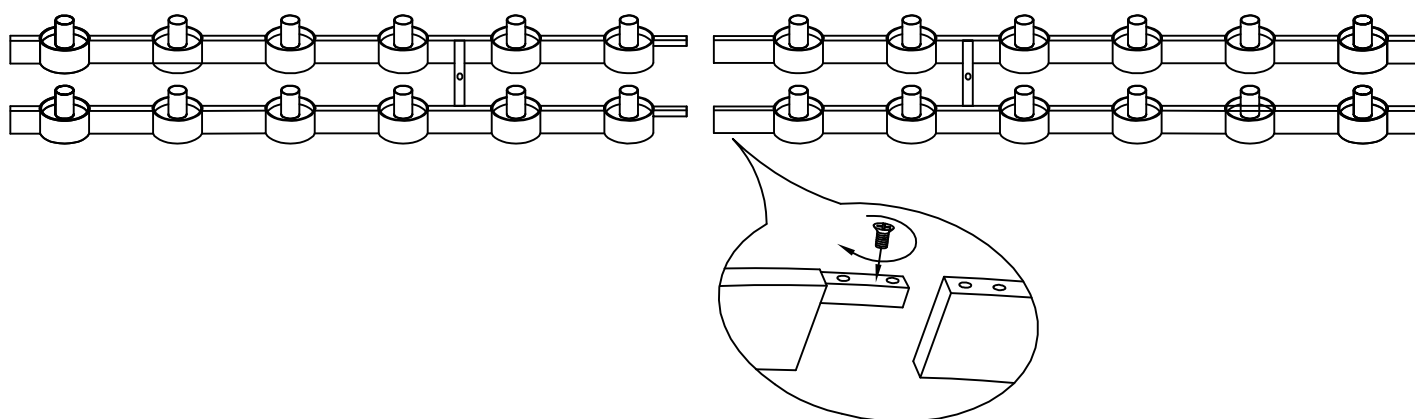

② Light source and lampshade assembly:

- (1) Take out the mounting plate and connect it to the wall.
- (2) Connect the power supply main wire to the main wire of the light fixture and secure the ceiling plate.
- (3) Screw the 20 E12 bulbs into the lamp holders (not included in the product).
- (4) Install the long and short glass shades into the light fixture in sequence.
- (5) Installation is complete.

