

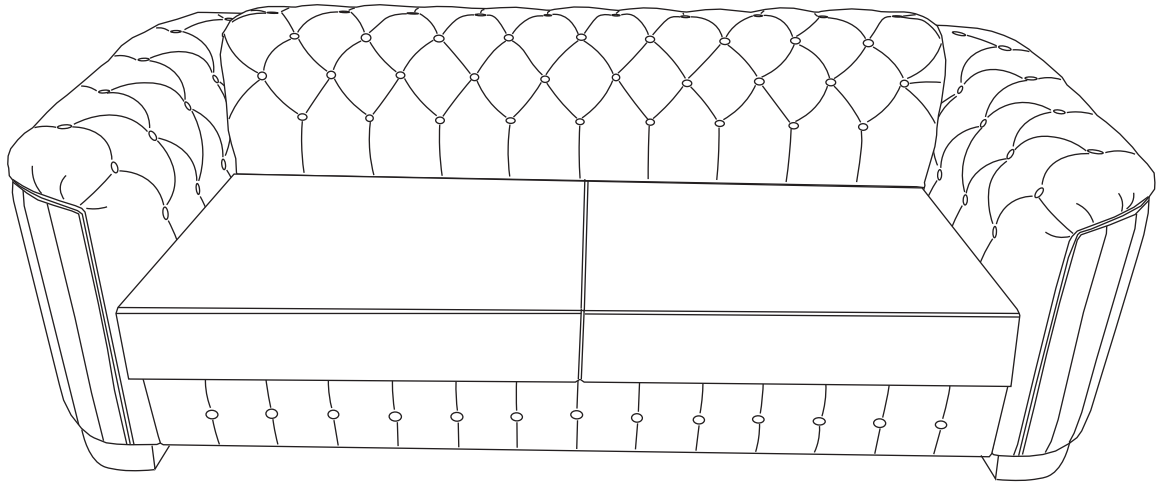

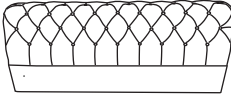

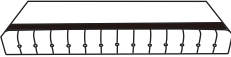

# SOFA

## ASSEMBLY INSTRUCTIONS

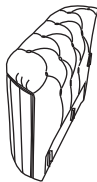

SOFA is packed in 3 cases

Carton	Disignation	Part		Hardware
S1	Backrest	#1		
S2	Seat frame	#2		#A #B #C #D #E
	Cushion	#3		
	Leg	#4		
	Support leg	#5		
ARM	Left arm	#6		
	Right arm	#7		

# ASSEMBLY INSTRUCTIONS

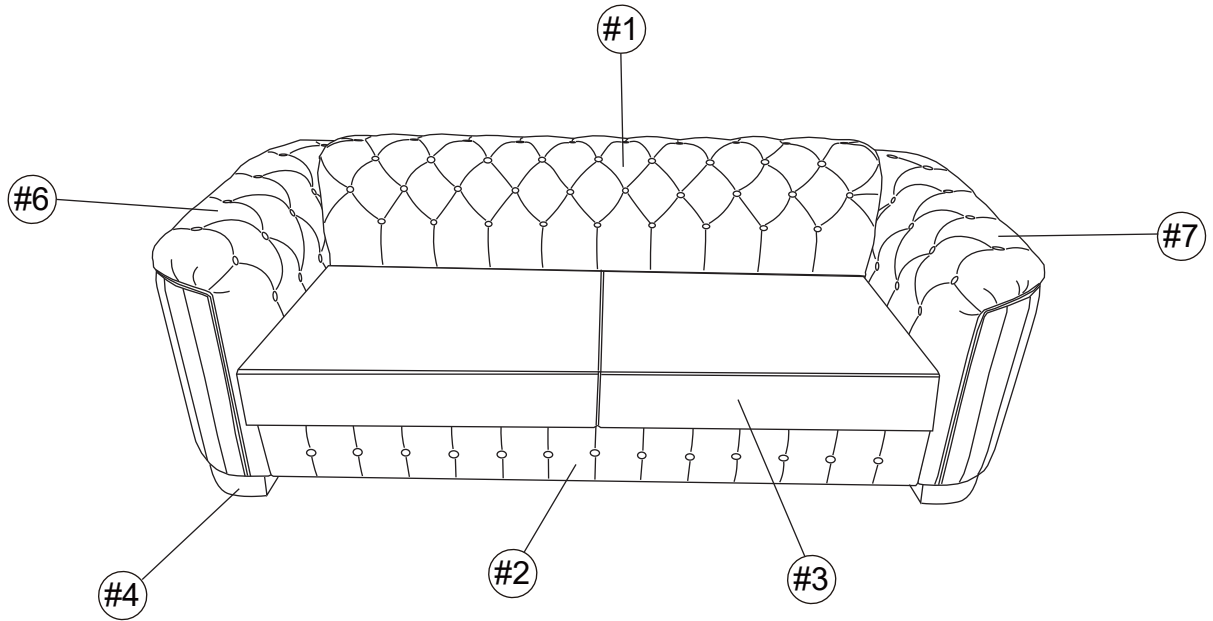

## PARTS

#1 1 pc

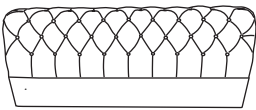

Backrest

#2 1 pc

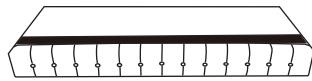

Seat frame

#3 2 pcs



Cushion

#4 4 pcs



Leg

#5 1 pc

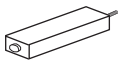

Support leg  
30\*30\*85MM

#6 1 pc

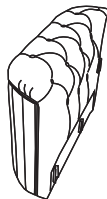

Left arm

#7 1 pc



Right arm

## HARDWARE

#A 4 pcs



BOLT 2-1/2 "L

#B 1 pc



ALLEN KEY 100mm L

#C 4 pcs



FLAT WASHER 16mm

#D 4 pcs



SPRING WASHER

#E 8 pcs



Screw 60mm L

# ASSEMBLY INSTRUCTIONS

## STEP 1:

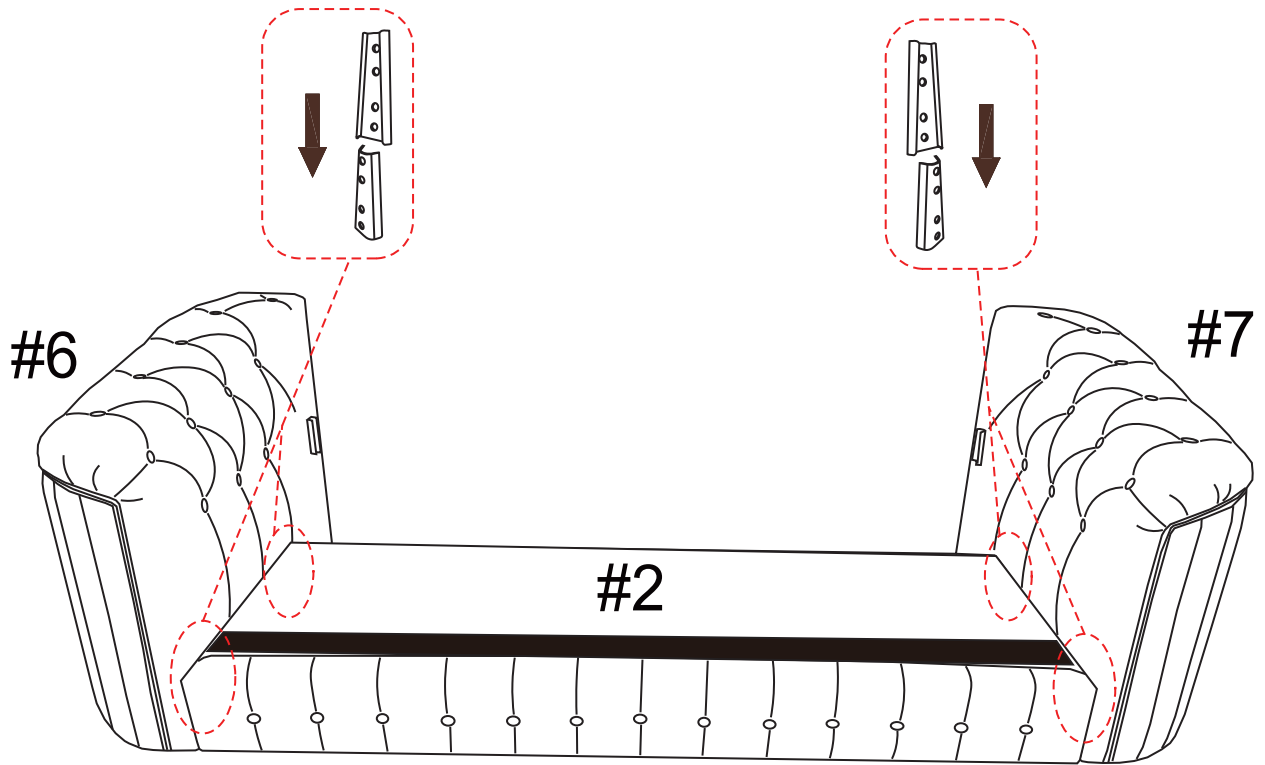

## STEP 2:

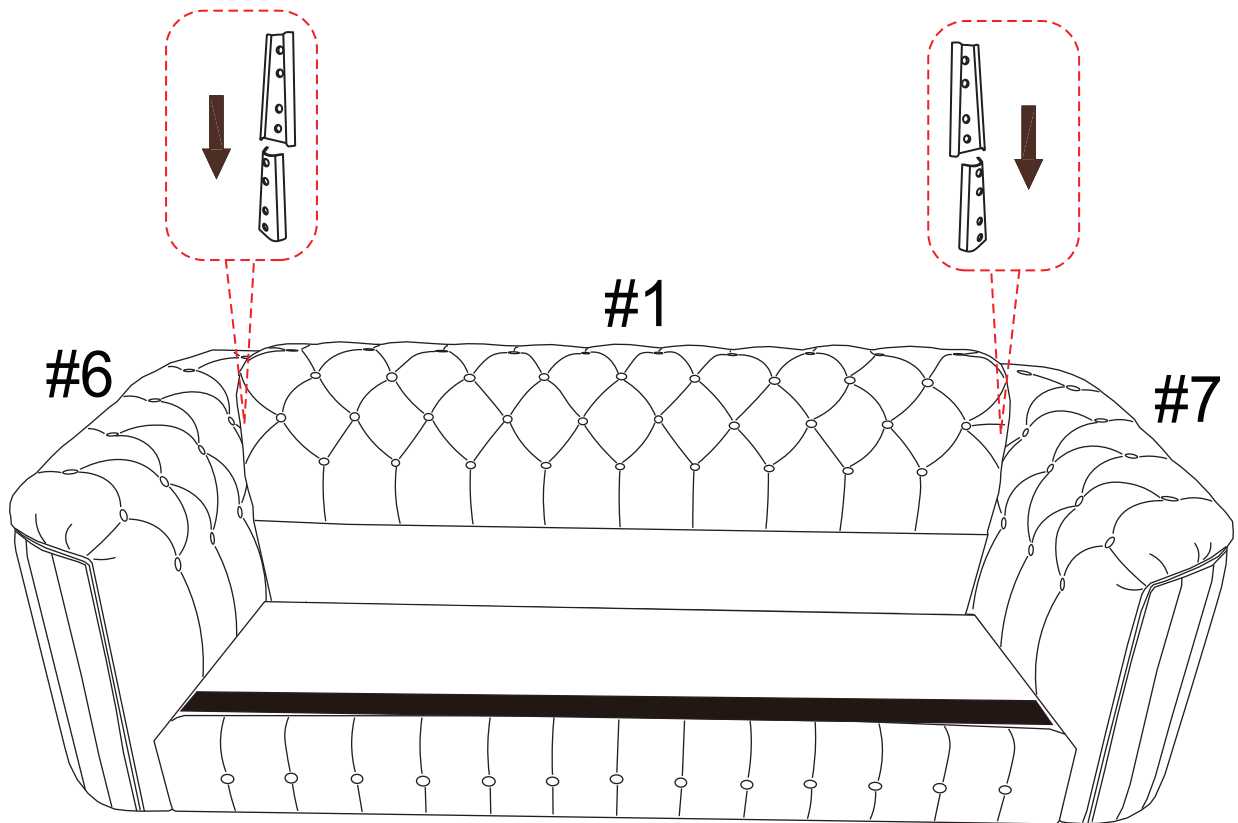

# ASSEMBLY INSTRUCTIONS

## STEP3:

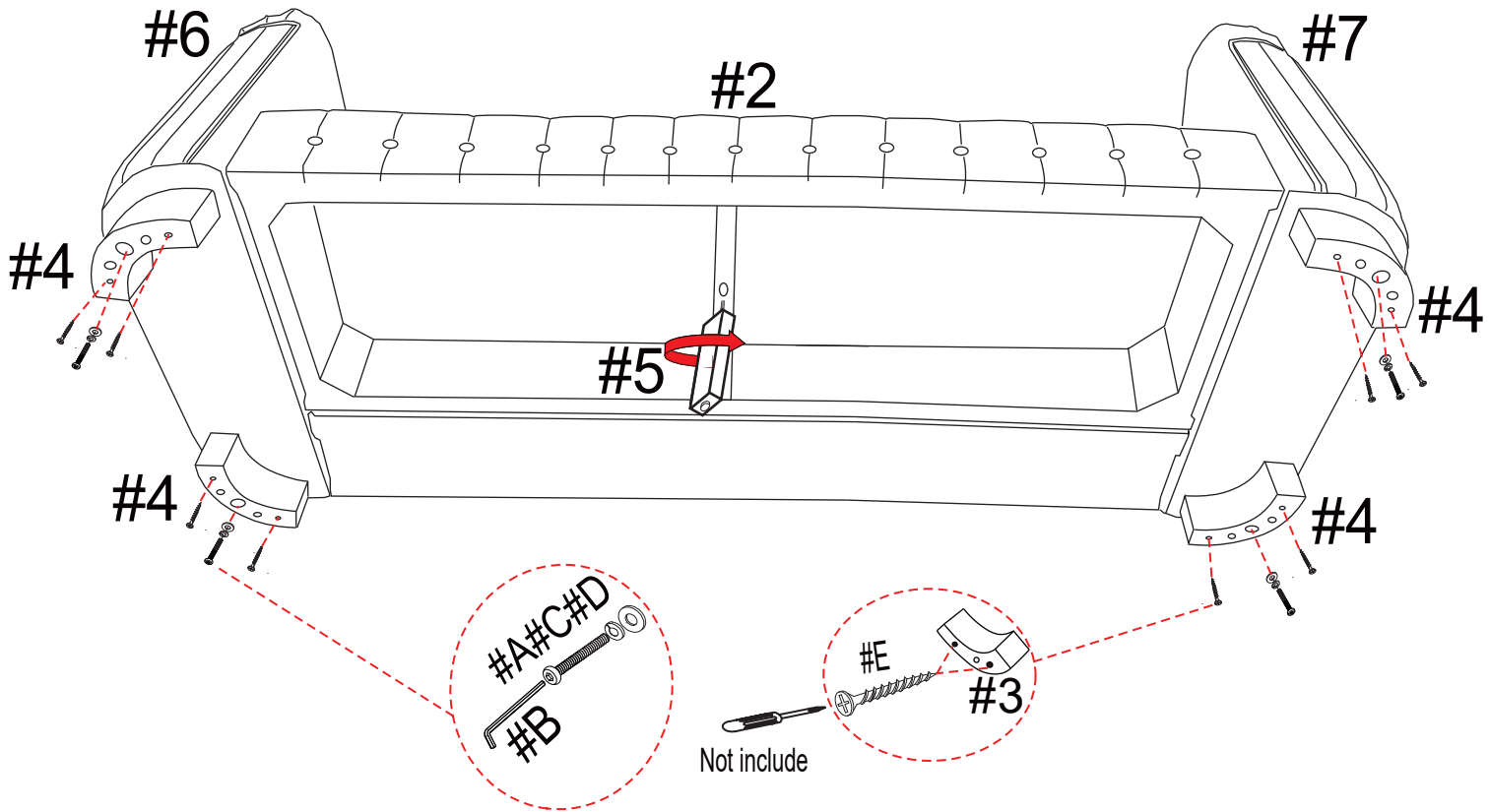

## STEP4:

