

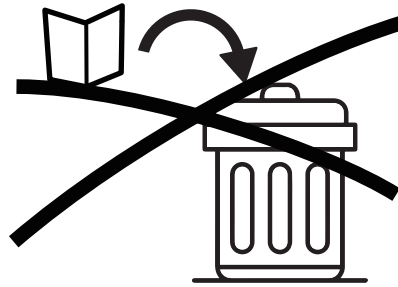

# **ASSEMBLY INSTRUCTIONS**

# NOTICE

IMPORTANT, RETAIN FOR FUTURE REFERENCE: READ CAREFULLY  
WICHTIG, FÜR SPÄTERE NACHSCHLAGE AUFBEWAHREN: SORGFÄLTIG LESEN  
IMPORTANTE, GUARDAR PARA REFERENCIA FUTURA: LEER ATENTAMENTE  
IMPORTANTE, CONSERVARE PER RIFERIMENTI FUTURI: LEGGERE ATTENTAMENTE  
IMPORTANT, À CONSERVER POUR RÉFÉRENCE FUTURE : LIRE ATTENTIVEMENT

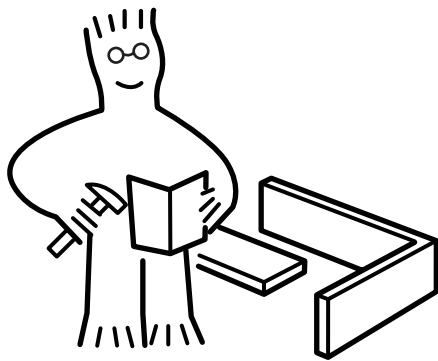

Assemble on a flat, clean and soft surface.  
Auf einer flachen, sauberen und weichen Oberfläche zusammenbauen.  
Assembler sur une surface plate, propre et douce.  
Assemblare su una superficie piatta, pulita e morbida.  
Ensamblar sobre una superficie plana, limpia y suave.

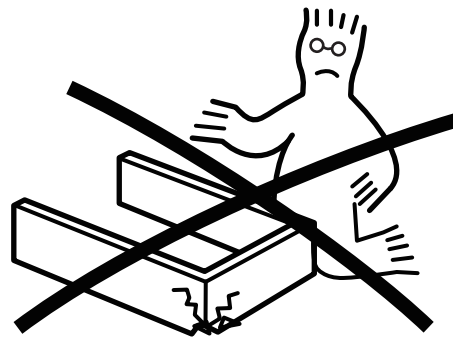
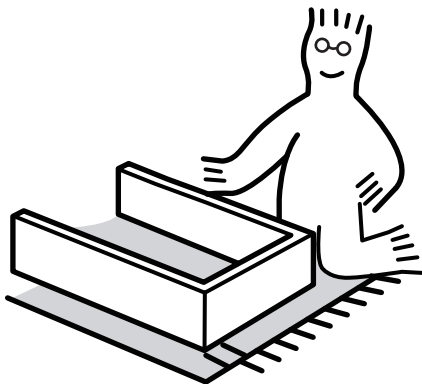

Professional installation is highly recommended.  
Eine professionelle Installation wird dringend empfohlen.  
Une installation professionnelle est fortement recommandée.  
Si raccomanda vivamente l'installazione professionale.  
Se recomienda altamente la instalación profesional.



Periodically Check That All Components Are Tightly Secured.  
Überprüfen Sie Regelmäßig, Dass Alle Komponenten Fest Gesichert Sind.  
Vérifiez Périodiquement Que Tous Les Composants Sont Bien Fixés.  
Controllare Periodicamente Che Tutti I Componenti Siano Ben Fissati.  
Verifique Periódicamente Que Todos Los Componentes Estén Bien Asegurados.



It is recommended that multiple people assemble this product.  
 Es wird empfohlen, dass mehrere Personen dieses Produkt zusammenbauen.  
 Il est recommandé que plusieurs personnes assemblent ce produit.  
 Si raccomanda che più persone assemblino questo prodotto.  
 Se recomienda que varias personas ensamblen este producto.

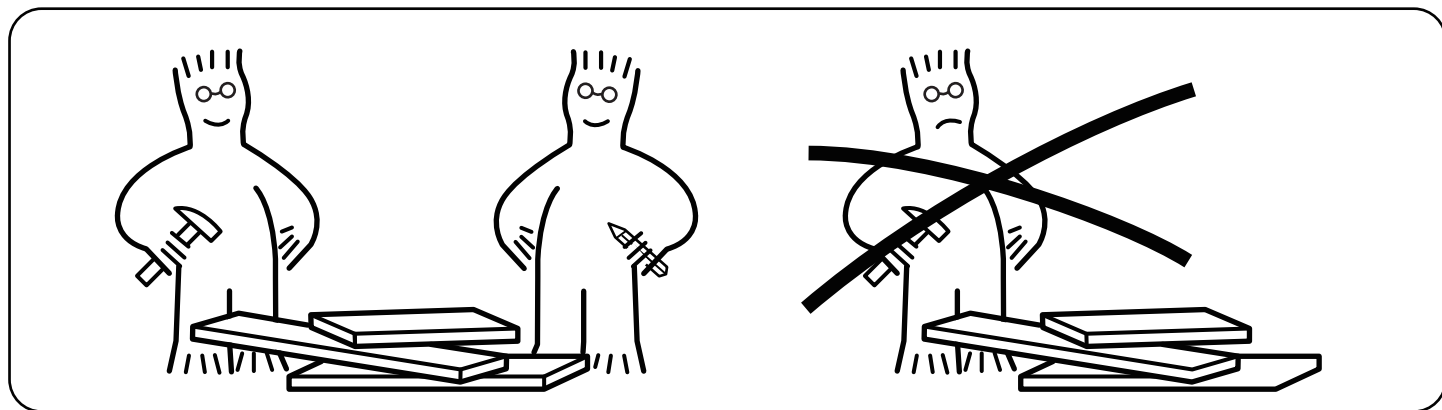

Serious or fatal crushing injuries can occur from furniture tip-over. Always secure this furniture to the wall using tip-over restraints.

Schwere oder tödliche Quetschverletzungen können durch das Umkippen von Möbeln verursacht werden. Sichern Sie diese Möbel immer mit Kipp-Sicherungen an der Wand.

Des blessures graves ou mortelles par écrasement peuvent survenir en cas de basculement de meubles. Fixez toujours ces meubles au mur à l'aide de dispositifs anti-basculement.

Lesioni gravi o mortali da schiacciamento possono verificarsi a causa del ribaltamento dei mobili. Fissare sempre questi mobili alla parete utilizzando i sistemi di blocco anti-ribaltamento.

Pueden ocurrir lesiones graves o fatales por aplastamiento debido al volcamiento de muebles. Siempre asegure este mueble a la pared utilizando dispositivos anti-vuelco.

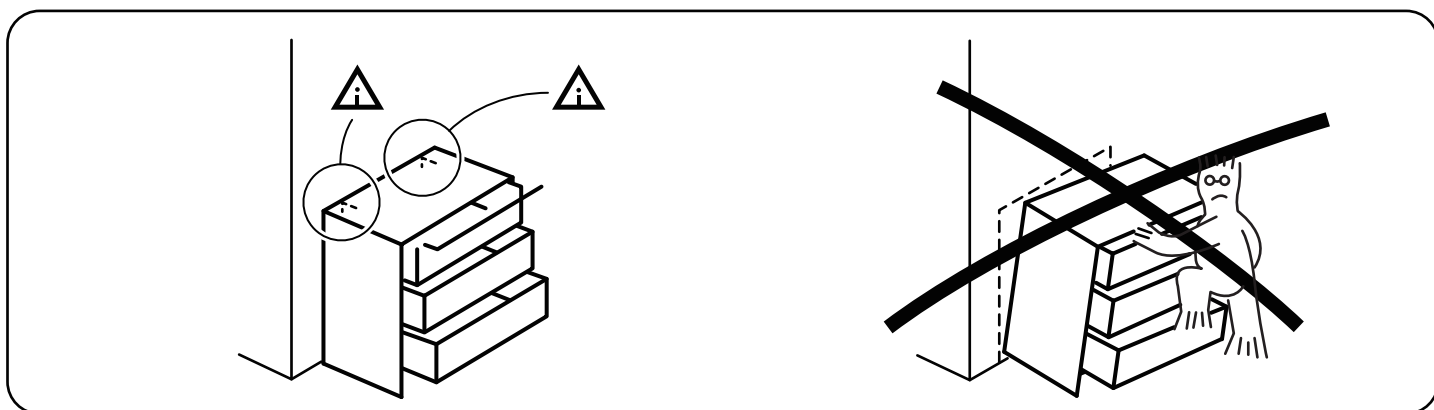

Please have the following auxiliary tools ready:  
 Bitte haben Sie die folgenden Hilfswerkzeuge bereit:  
 Veuillez avoir les outils auxiliaires suivants à portée de main:  
 Si prega di avere pronti i seguenti strumenti ausiliari:  
 Por favor, tenga listos las siguientes herramientas auxiliares:

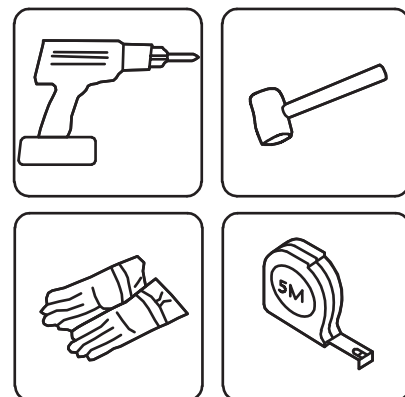

USING CAM LOCK AND QUICKFIT  
 VERWENDUNG VON NOCKENSCHLOSS UND QUICKFIT  
 UTILISATION DE SERRURE À CAME ET QUICKFIT  
 USO DI SERRATURA A LEVA E QUICKFIT  
 USANDO EL CIERRE DE LEVA Y QUICKFIT

Tighten QuickFit until the shoulder is flush with the panel. Do not overtighten or undertighten.  
 Ziehen Sie den Quickfit an, bis die Schulter bündig mit der Platte ist. Nicht zu fest oder zu locker anziehen.

Serrez le quickfit jusqu'à ce que l'épaule soit affleurant avec le panneau. Ne serrez pas trop ou trop peu.

Stringere il quickfit fino a quando la spalla è a filo con il pannello. Non stringere troppo o troppo poco.

Apriete el quickfit hasta que el hombro esté al ras con el panel. No apriete demasiado ni demasiado poco.

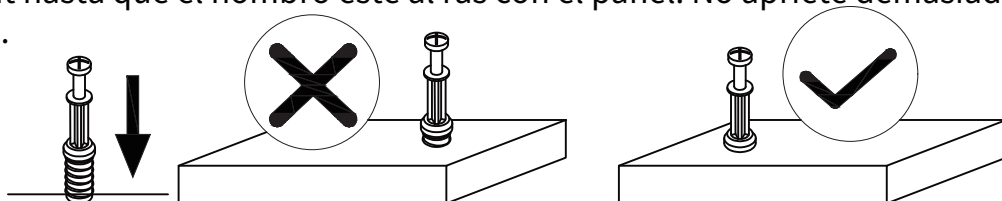

When fitting the cam lock, ensure the starting position is correct before inserting the connecting QuickFit.

Stellen Sie beim Einbau des Nockenschloss sicher, dass die Startposition korrekt ist, bevor Sie den verbindenden Quickfit einsetzen.

Lors de la pose du serrure à came, assurez-vous que la position de départ est correcte avant d'insérer le quickfit de connexion.

Quando si monta il serratura a leva, assicurarsi che la posizione di partenza sia corretta prima di inserire il quickfit di collegamento.

Al instalar el cierre de leva, asegúrese de que la posición inicial sea correcta antes de insertar el quickfit de conexión.

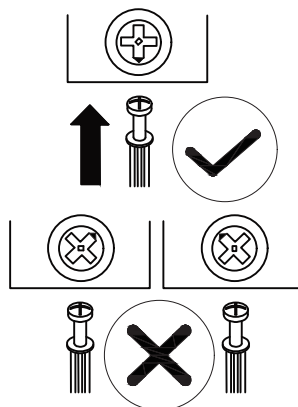

The QuickFit head should be in the center of the cam lock when the two panels are joined. The cam lock should be inserted before the QuickFit. Turn the cam lock clockwise to tighten.

Der Quickfit-Kopf sollte sich in der Mitte des Nockenschloss befinden, wenn die beiden Platten verbunden sind. Der Nockenschloss sollte vor dem Quickfit eingesetzt werden. Drehen Sie den Nockenschloss im Uhrzeigersinn, um ihn zu befestigen.

La tête du quickfit doit être au centre du serrure à came lorsque les deux panneaux sont assemblés. Le serrure à came doit être inséré avant le quickfit. Tournez le serrure à came dans le sens des aiguilles d'une montre pour le serrer.







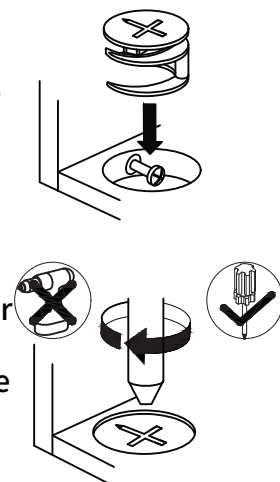



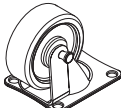



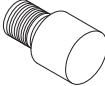
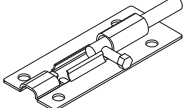

La testa del quickfit dovrebbe essere al centro del serratura a leva quando i due pannelli sono uniti. Il serratura a leva deve essere inserito prima del quickfit.

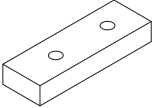
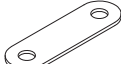
Ruotare il serratura a leva in senso orario per stringere.

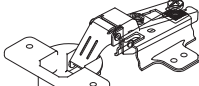
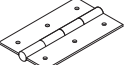
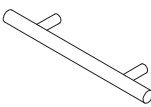

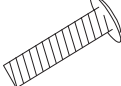
La cabeza del quickfit debe estar en el centro del cam lock cuando los dos paneles estén unidos. El cierre de leva debe insertarse antes del quickfit. Gire el cierre de leva en sentido horario para apretar.

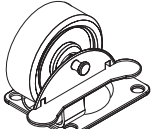

# PARTS

Item no. Nr. N° d'article Articolo No. Artículo No.	Reference Image Referenzbild Image de référence Immagine di riferimento Imagen de referencia	Qty. Menge Qté. Qtà Cant.	Item no. Nr. N° d'article Articolo No. Artículo No.	Reference Image Referenzbild Image de référence Immagine di riferimento Imagen de referencia	Qty. Menge Qté. Qtà Cant.
(A)	$\phi 6 \times 35 \text{MM}$ 	X18	(L)		X2
(B)	$\phi 15 \times 9 \text{MM}$ 	X18	(M)		X2
(C)	$\phi 4 \times 35 \text{MM}$ 	X6	(N)		X2
(D)		X2	(O)		X1
(E)	$\phi 8 \times 30 \text{MM}$ 	X12	(P)	$\phi 4 \times 10 \text{MM}$ 	X4
(F)		X2	(Q)		X2
(G)	$\phi 4 \times 15 \text{MM}$ 	X50	(R)		X2
(H)		X6	(S)		X2
(I)		X4	(T)	$\phi 4 \times 25 \text{MM}$ 	X4
(J)	$\phi 3 \times 12 \text{MM}$ 	X48	(U)		X8
(K)		X2	(V)		X4

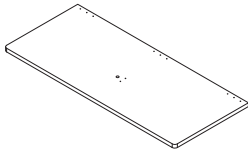
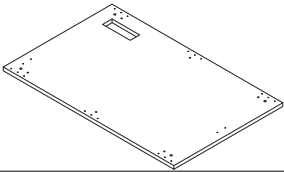
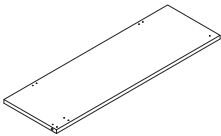
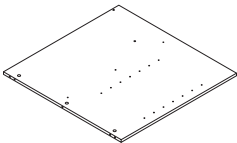
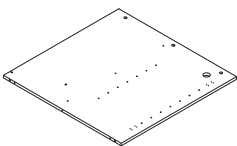
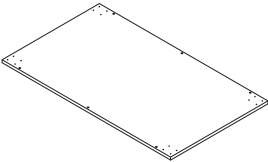
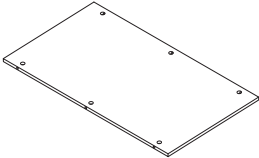
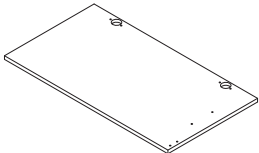

Item no. Nr. N° d'article Articolo No. Artículo No.	Reference Image Referenzbild Image de référence Immagine di riferimento Imagen de referencia	Qty. Menge Qté. Qtà Cant.
1		X2
2		X1
3		X2
4		X1
5		X1
6		X1
7		X1
8		X1
9		X1

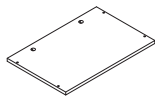
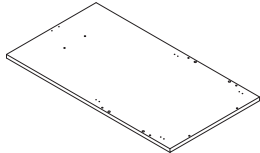
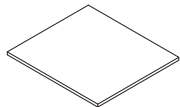
Item no. Nr. N° d'article Articolo No. Artículo No.	Reference Image Referenzbild Image de référence Immagine di riferimento Imagen de referencia	Qty. Menge Qté. Qtà Cant.
10		X1
11		X1
12		X1
13		X2

# EXPLODED VIEW

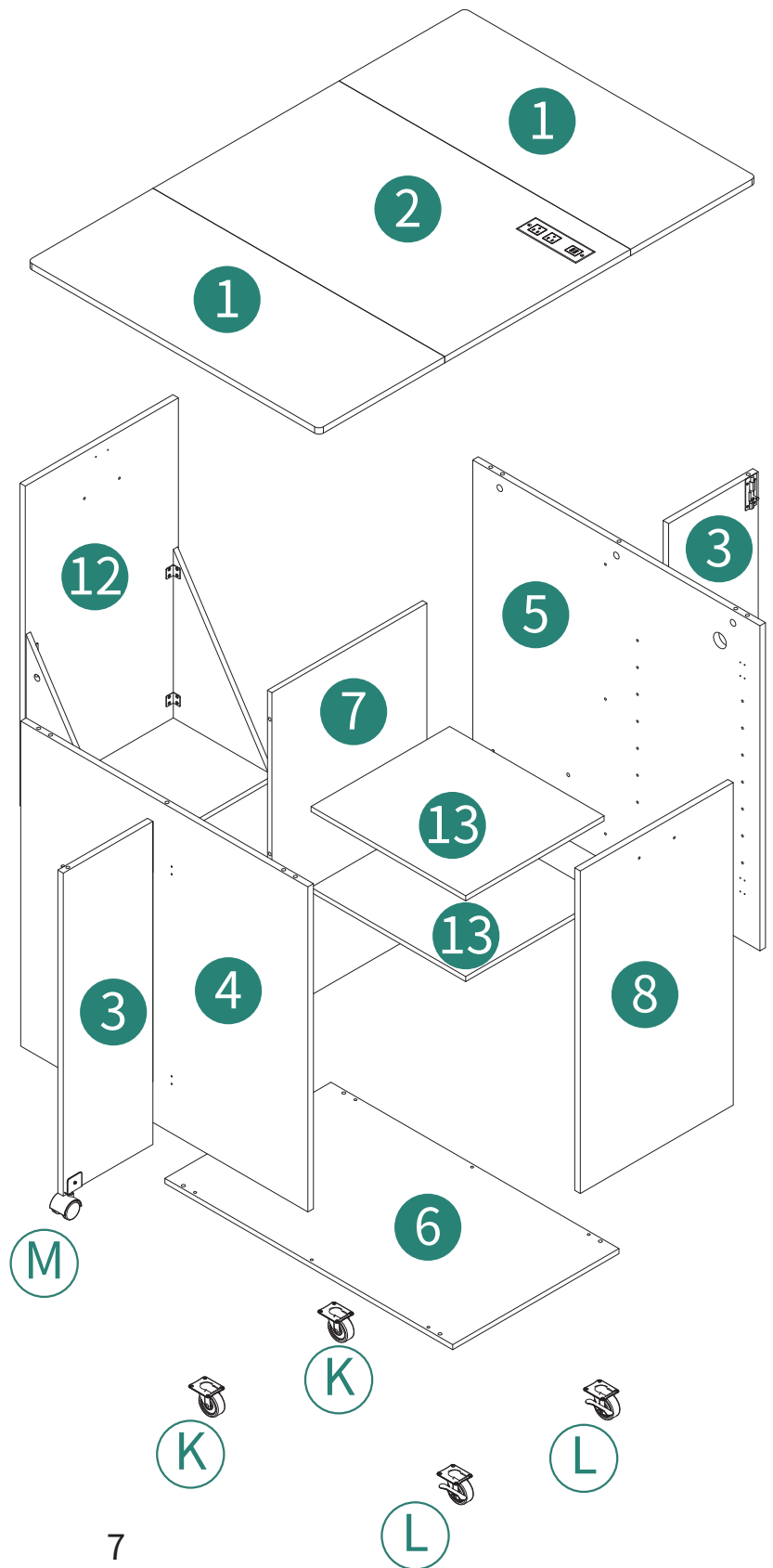
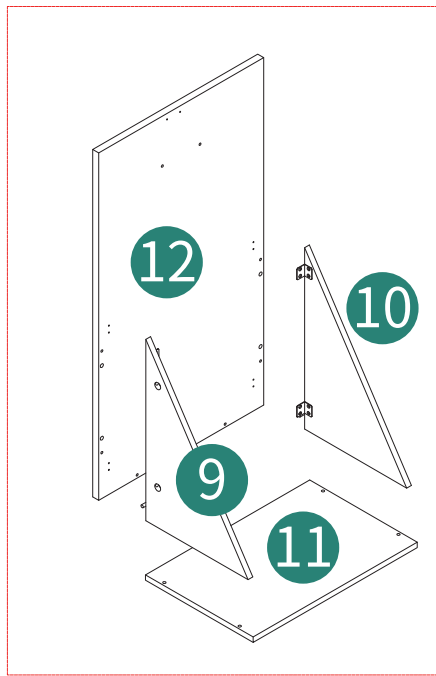

# ASSEMBLY

# 1

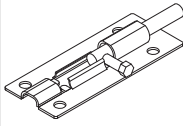

ⓓx2

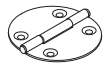

ⓐx4

φ3x12MM

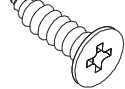

ⓐx16



Ⓜx2

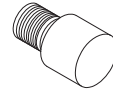

Ⓝx2

φ4x10MM

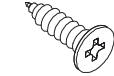

Ⓟx4

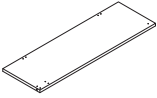

Ⓝx2

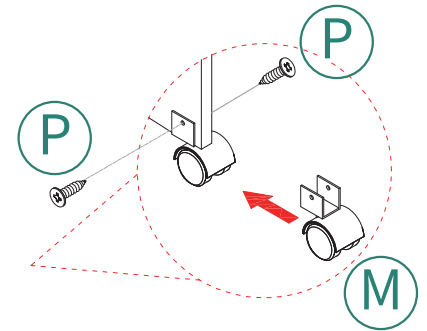
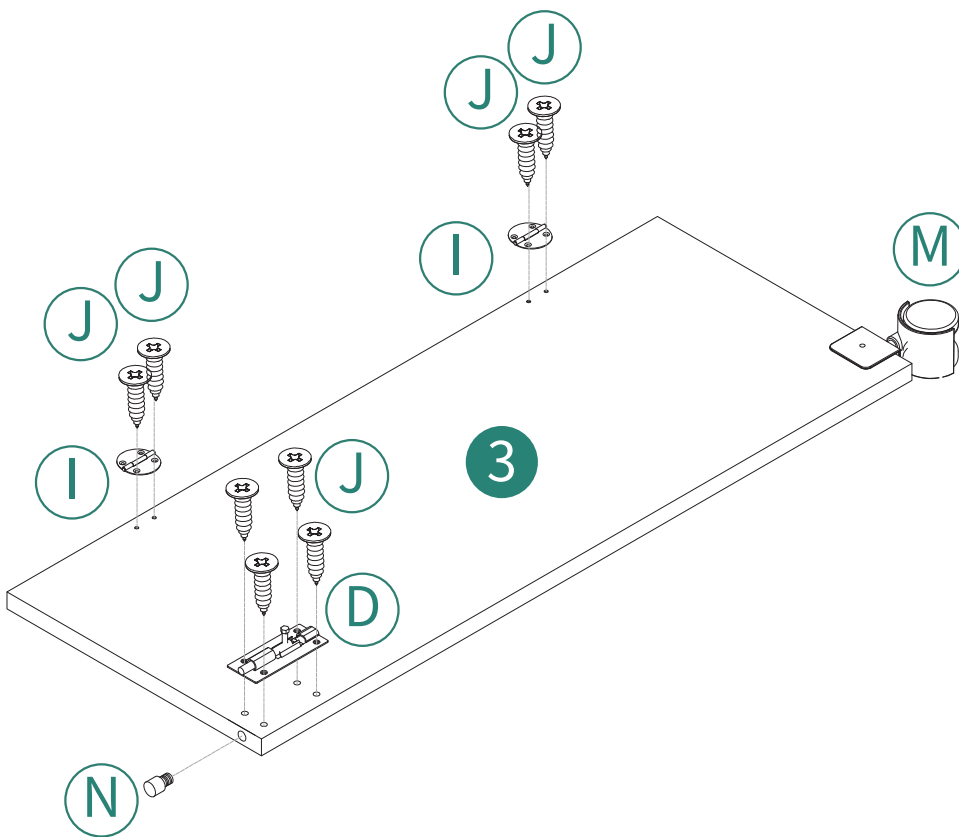

# X2

# 2

φ6x35MM



(A)x18

φ3x12MM

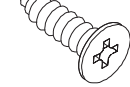

(J)x2

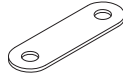

(Q)x1

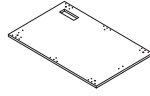

(2)x1

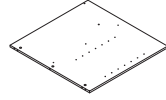

(4)x1

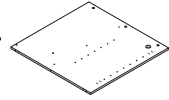

(5)x1

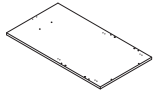

(12)x1

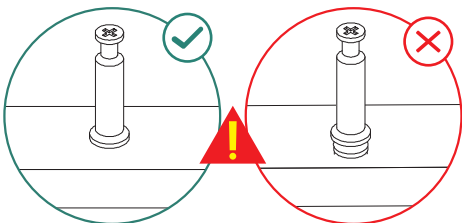
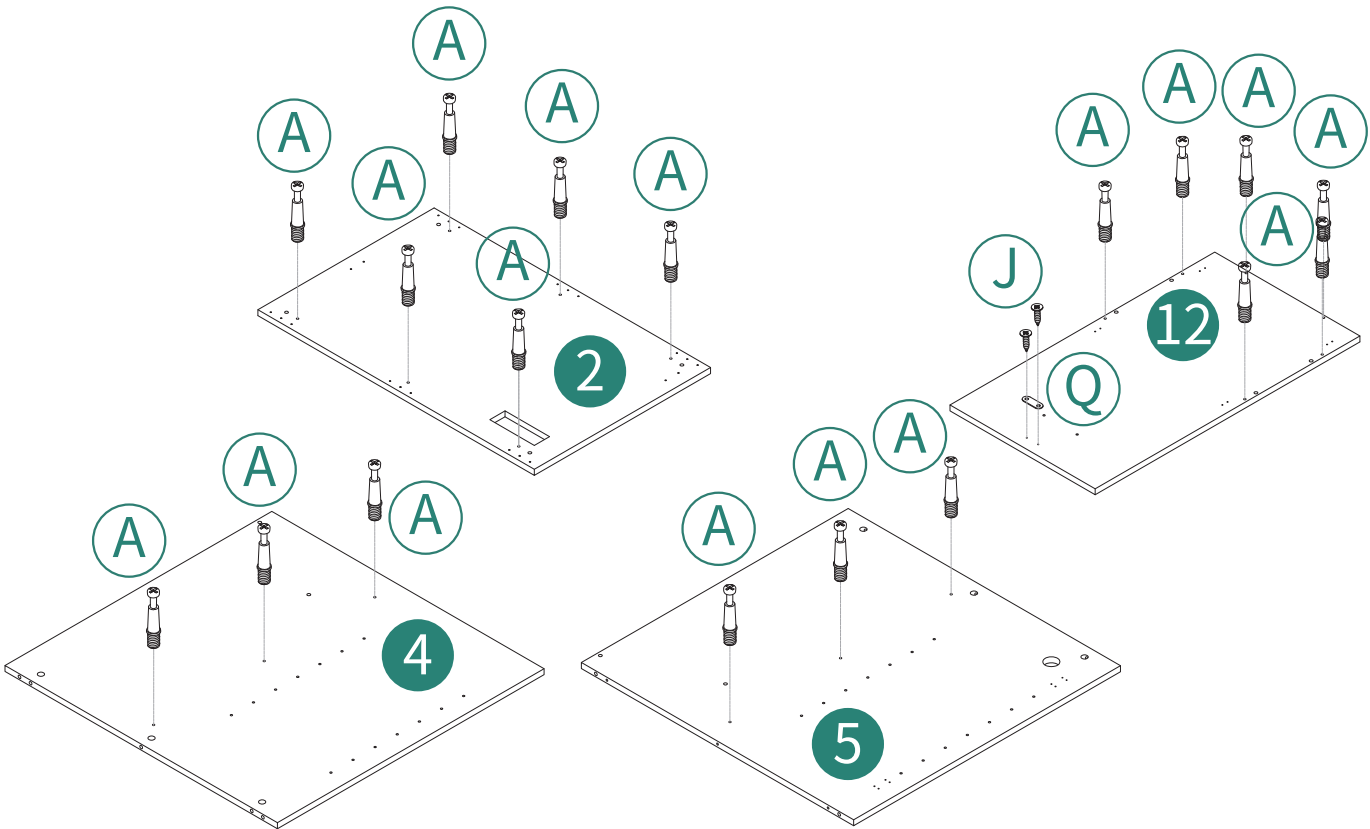

# 3

φ15x9MM



(B)x4

φ8x30MM

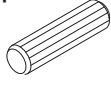

(E)x4

φ3x12MM

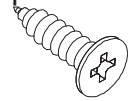

(J)x16



(V)x4

φ4x25MM



(Y)x4

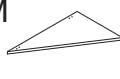

(9)x1

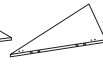

(10)x1

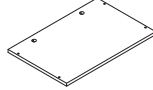

(11)x1

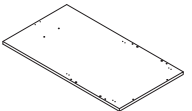

(12)x1

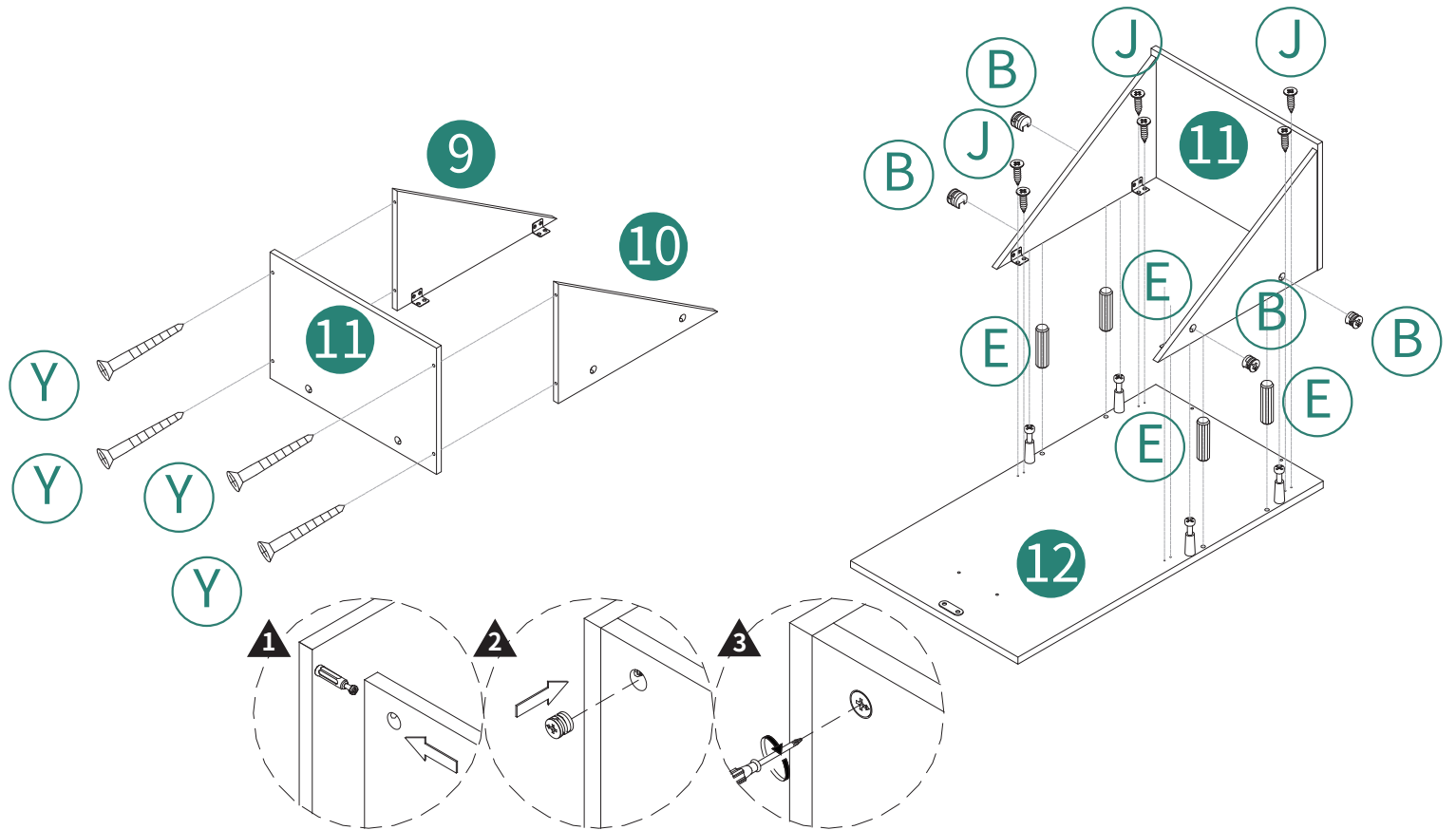
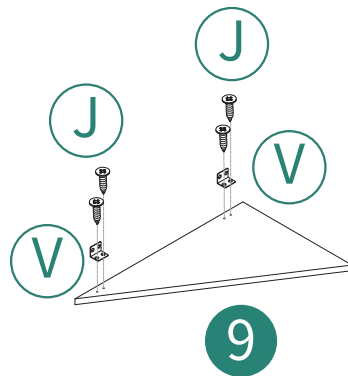
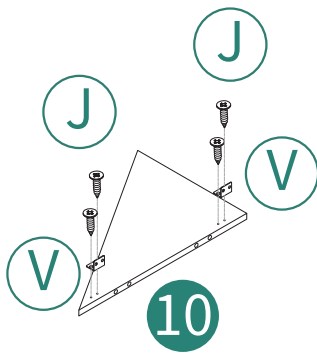

4

φ15x9MM



(B)x3

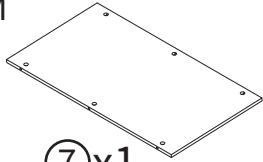

(7)x1

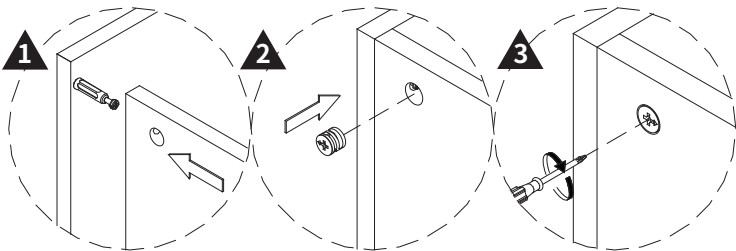
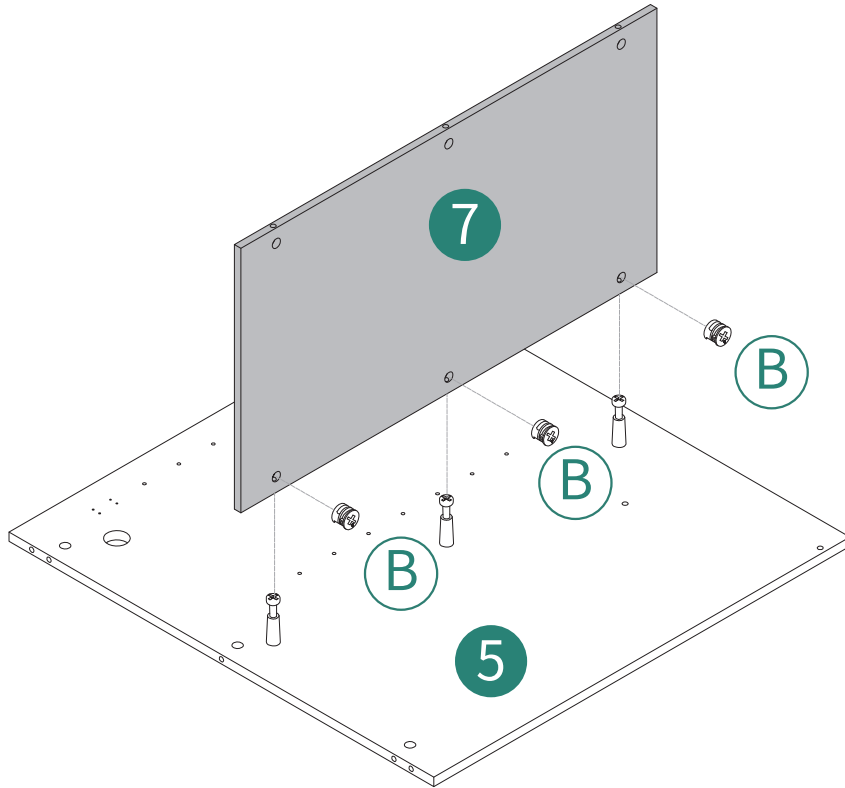

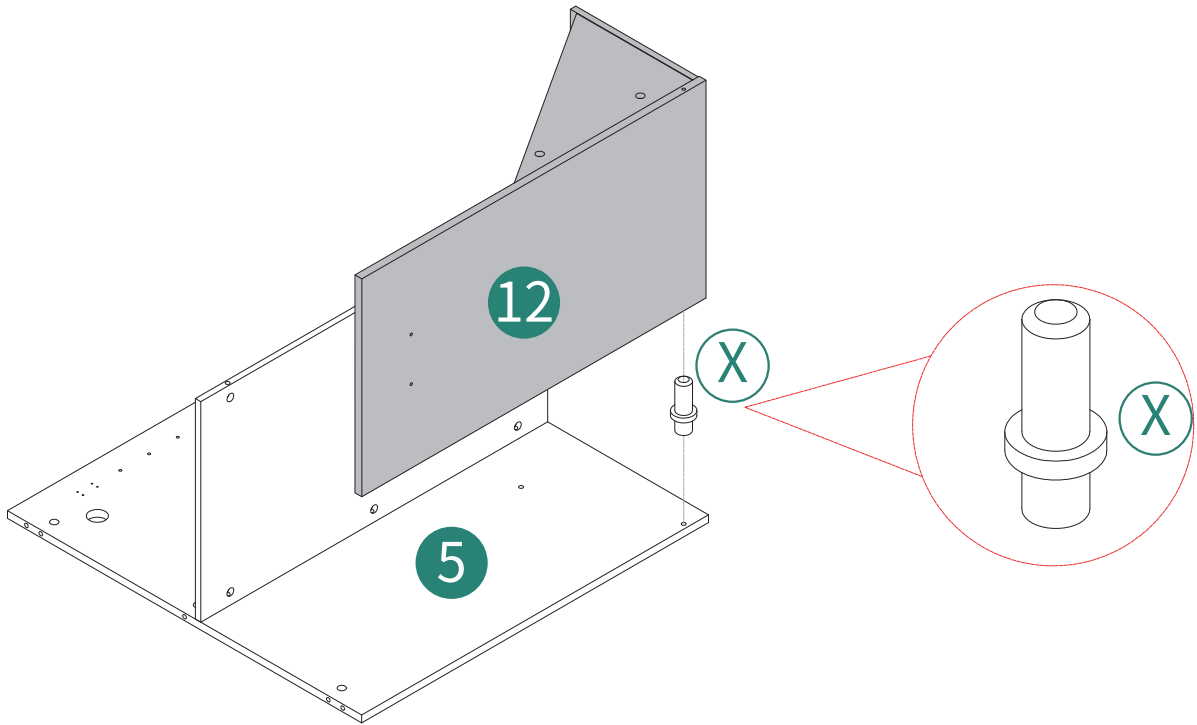
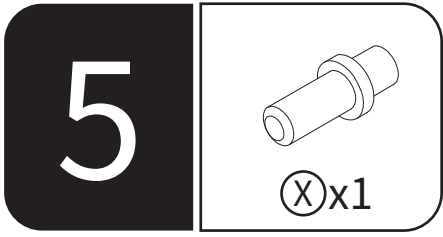

# 6

φ15x9MM



(B)x3

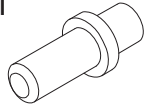

(X)x1

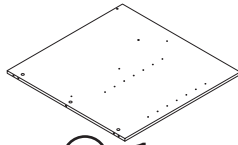

(4)x1

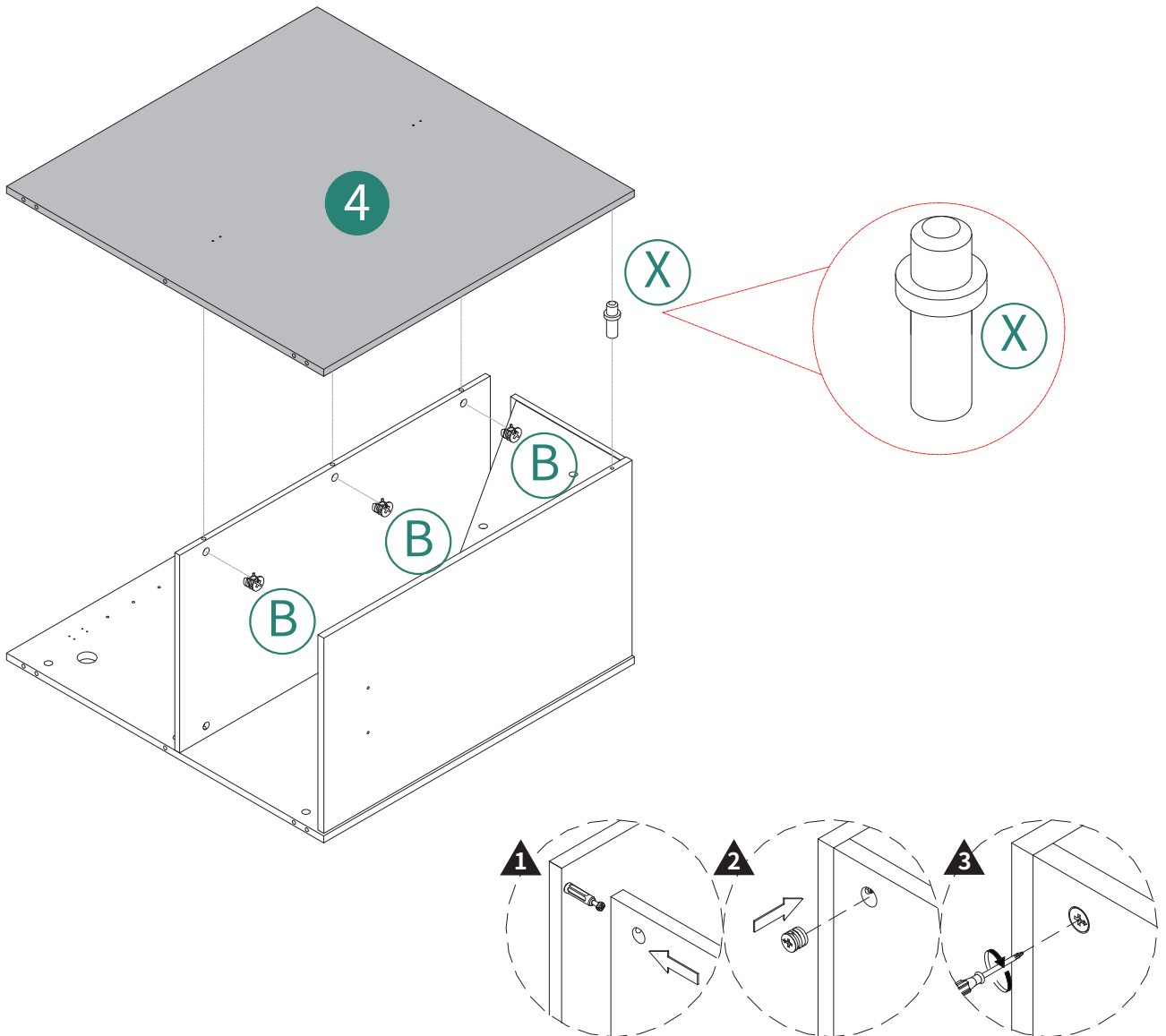

7

φ4x35MM



Ⓒx6

φ8x30MM

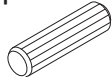

Ⓔx4

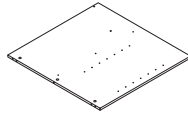

⑥x1

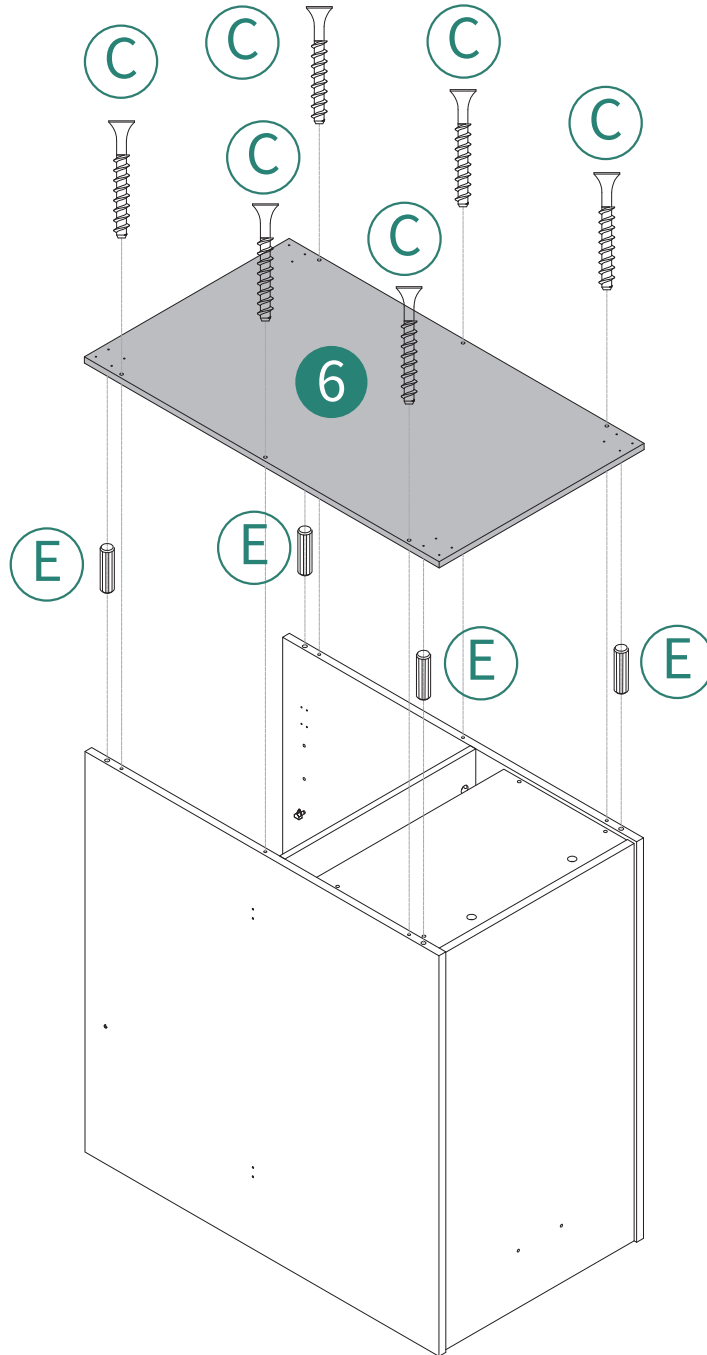

8



(K)x2

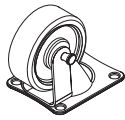

(L)x2

φ4x12MM



(L1)x16

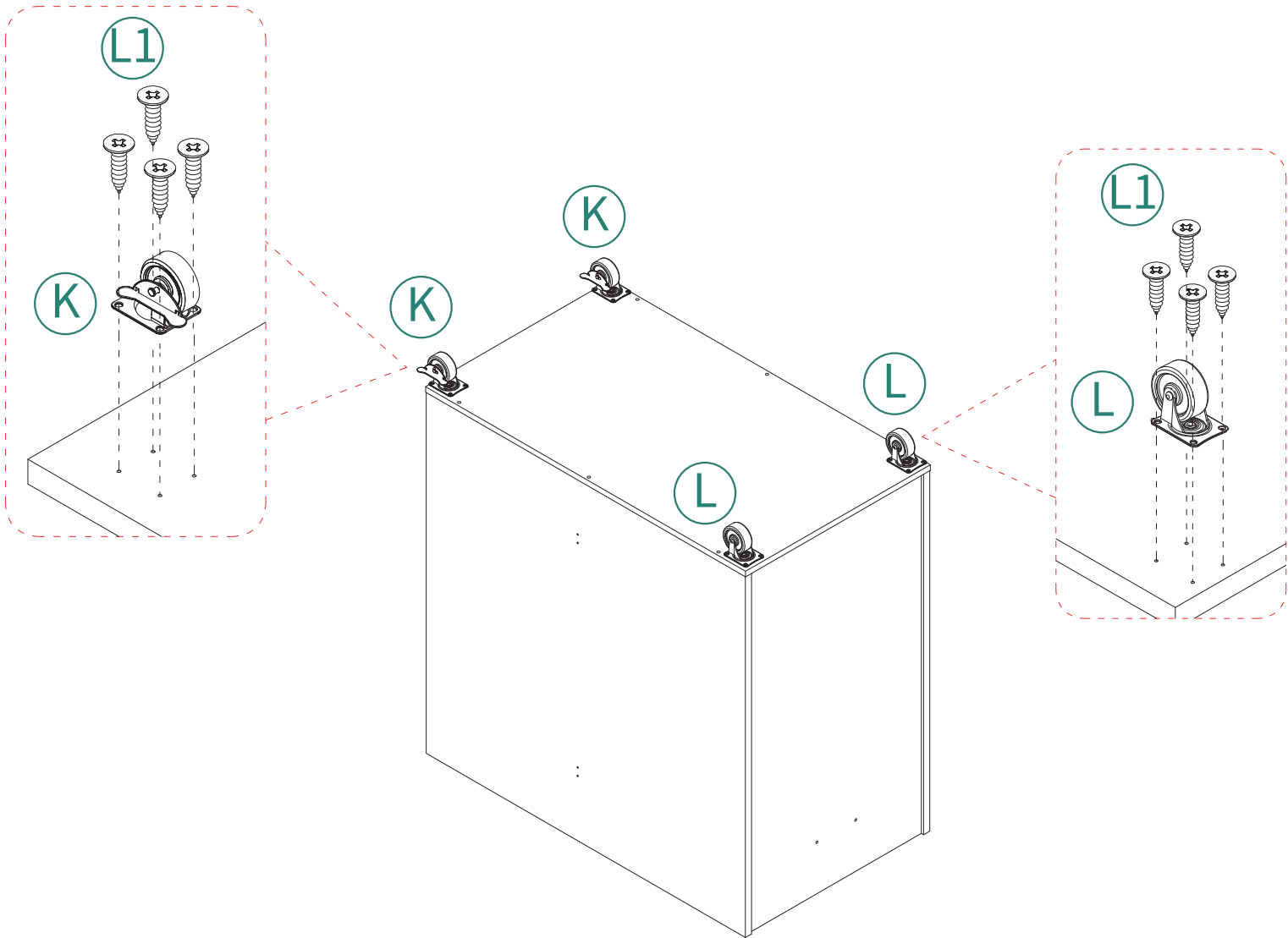

9

φ15x9MM



(B)x4

φ8x30MM

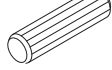

(E)x4

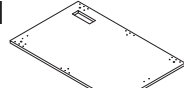

(2)x1

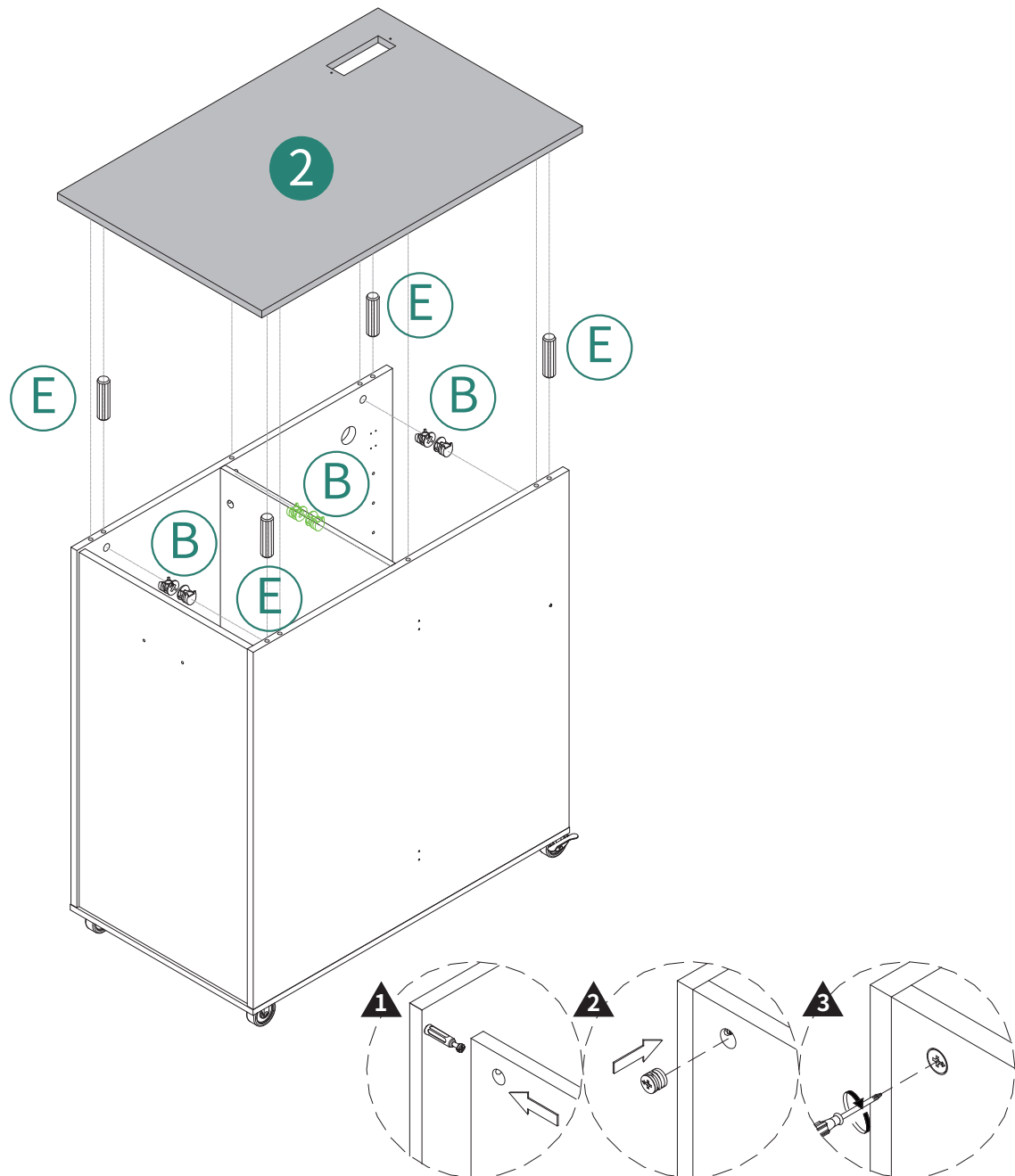

# 10

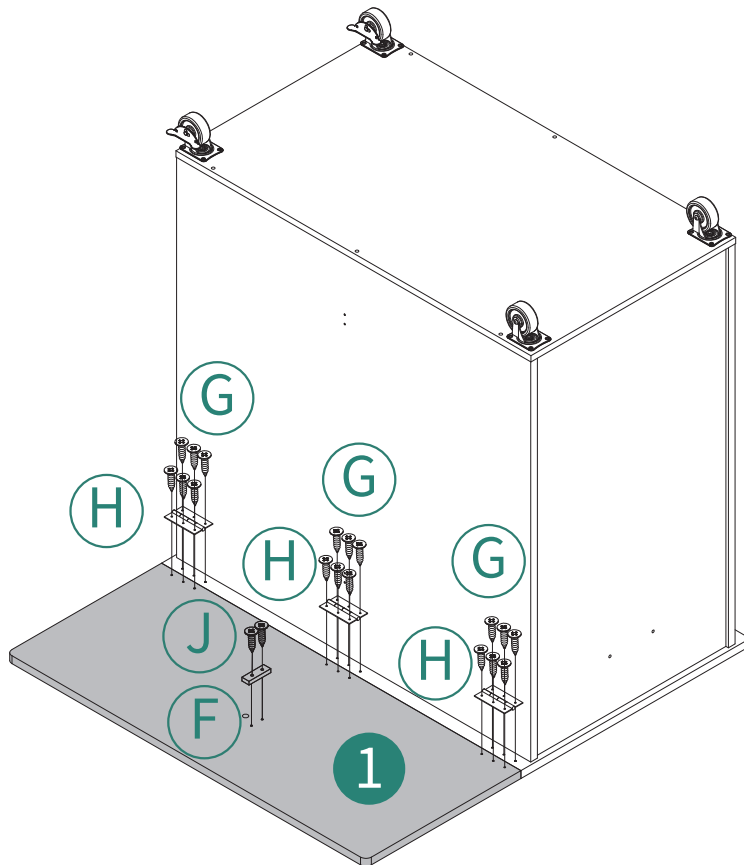
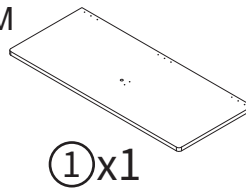
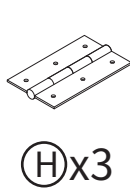
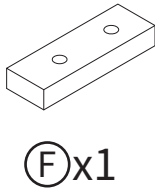

# 11

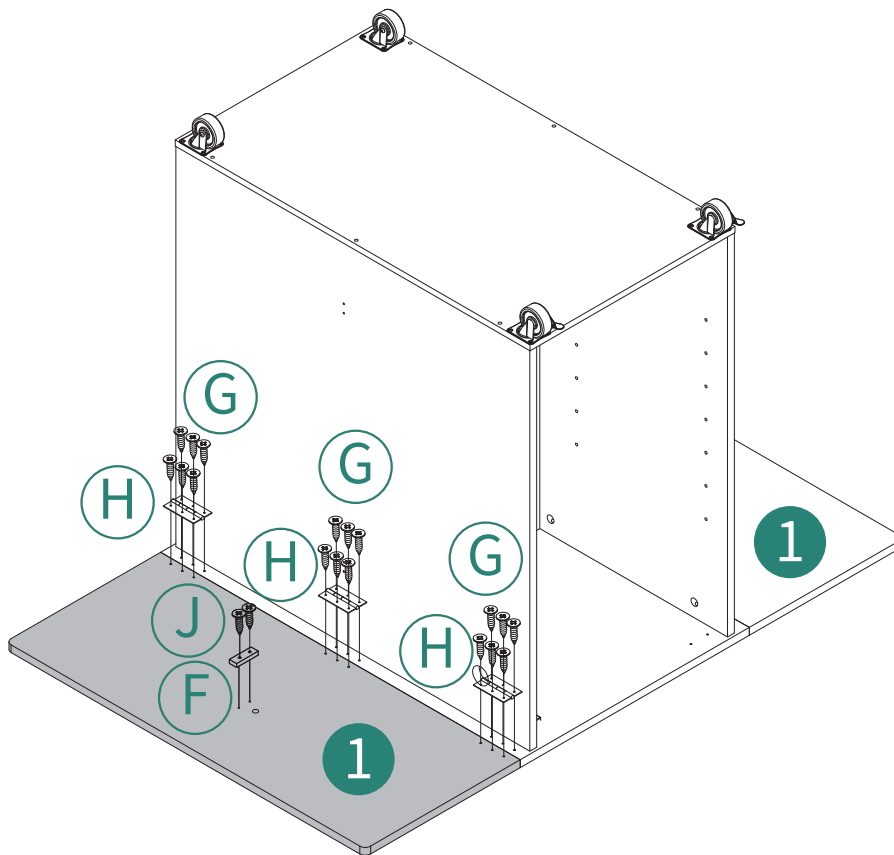
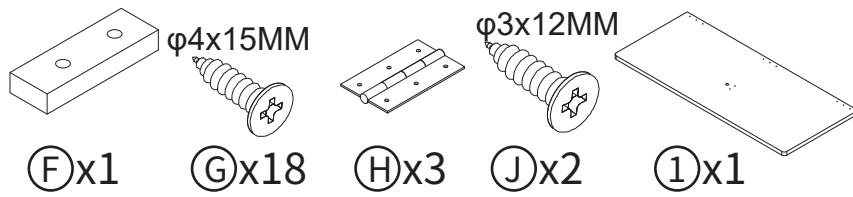

# 12

φ3x12MM

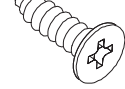

ⓐx4

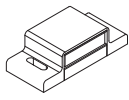

Ⓩx1

φ3x15MM

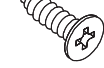

Ⓛ3

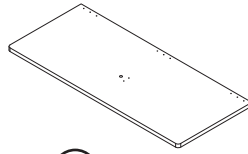

①x1

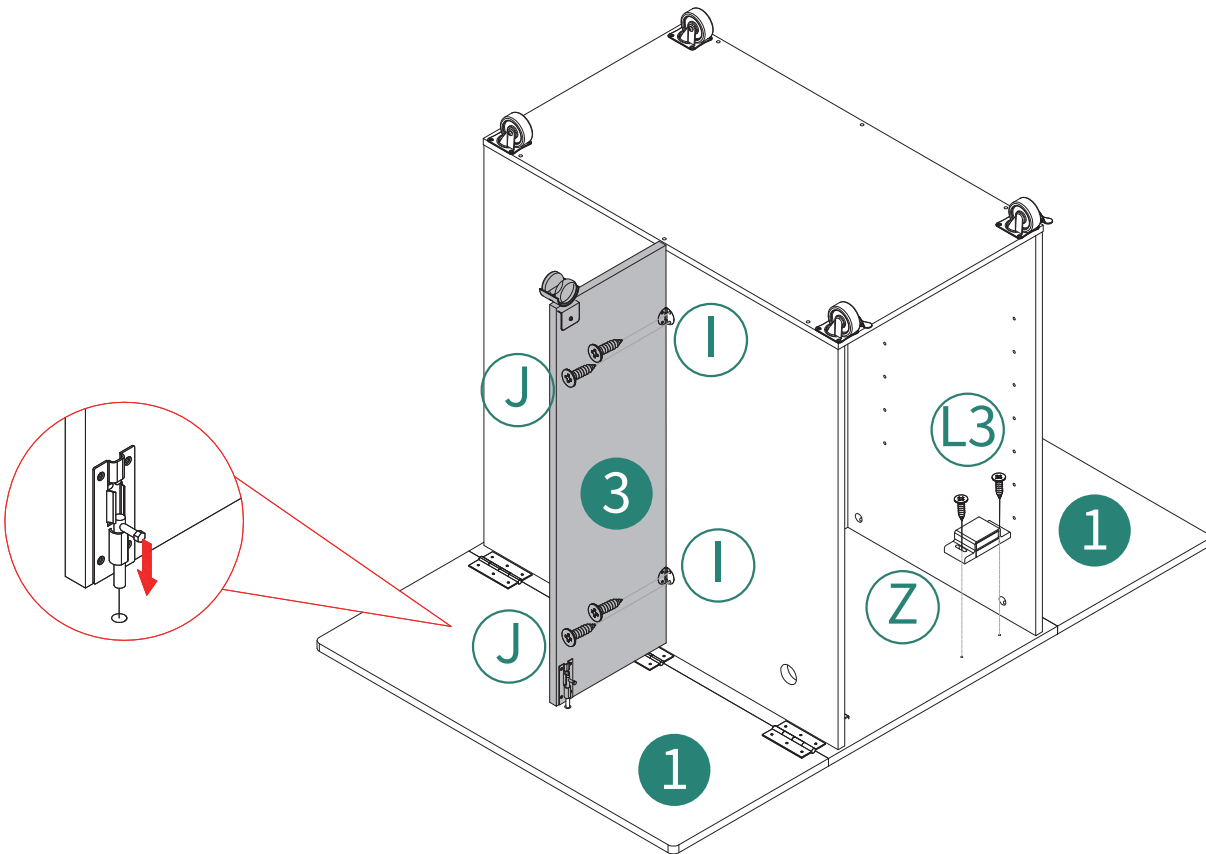

13

φ3x12MM

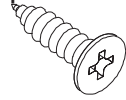

ⓐx4

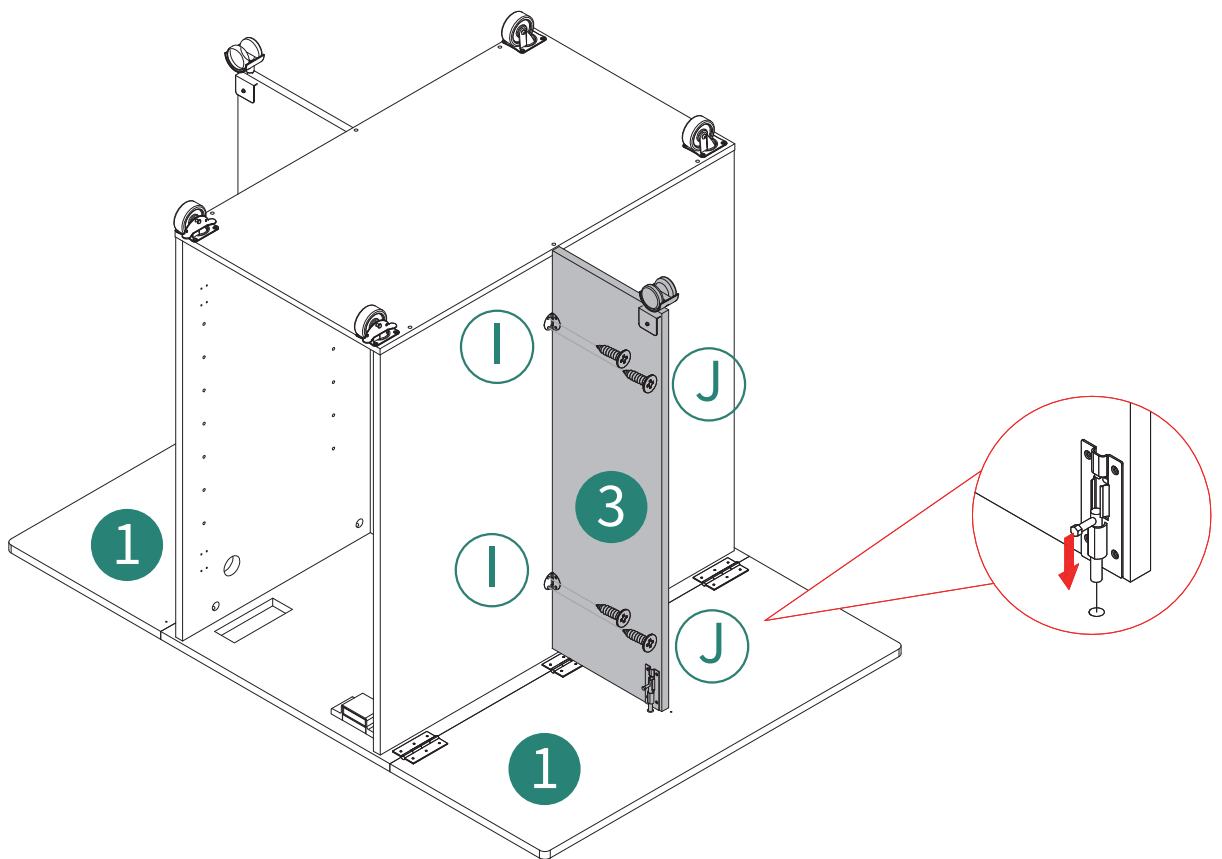

# 14

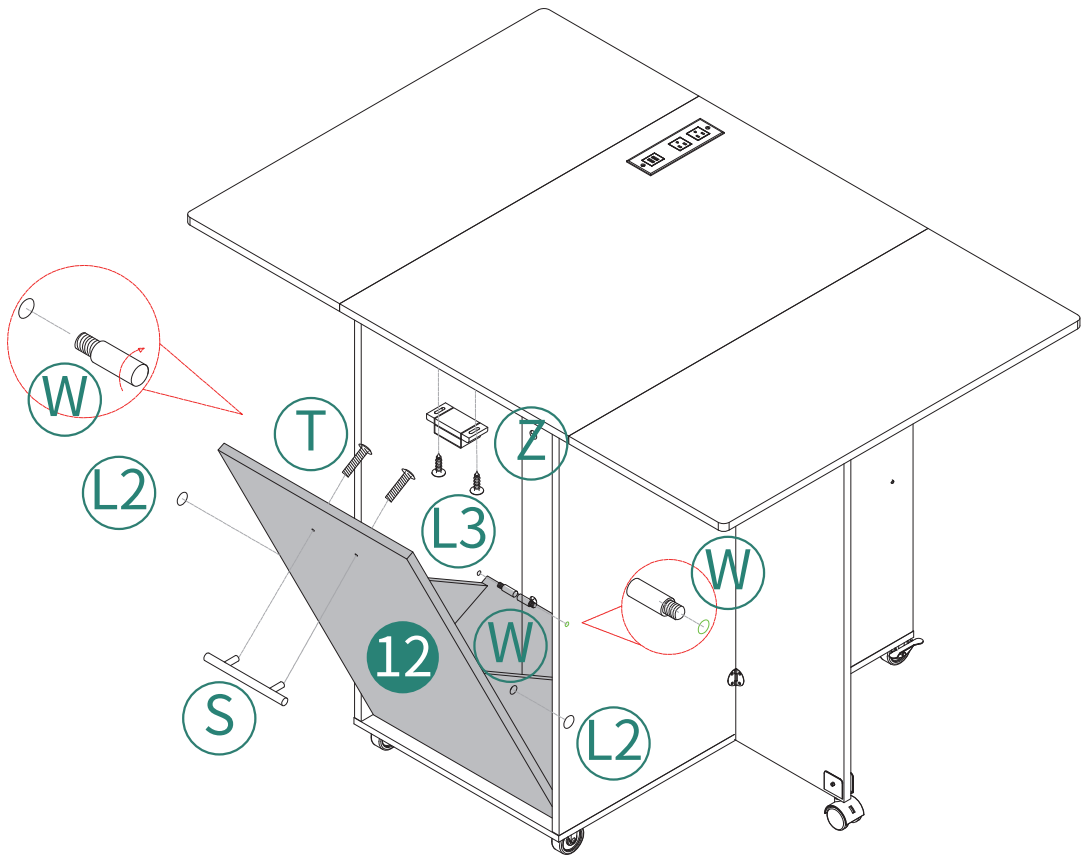
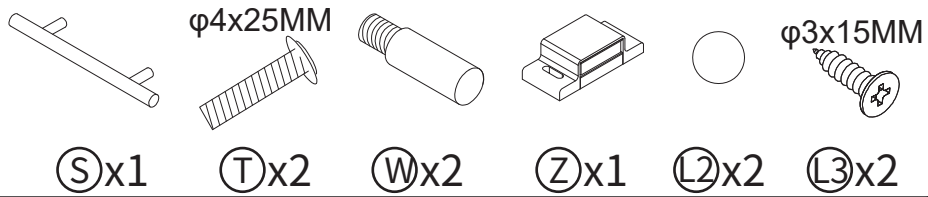

“ ⑤ ” Follow the color and pattern circular sticker, stick it on the screw hole position.

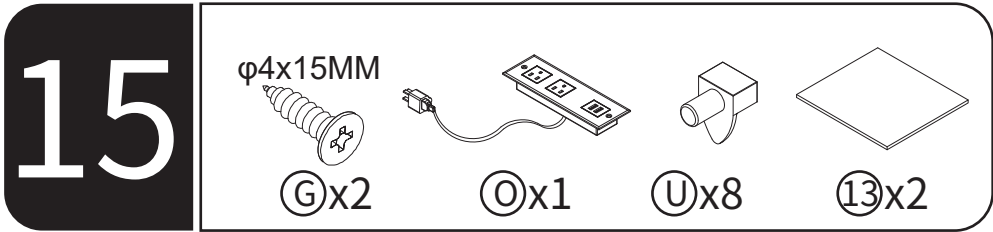

the wire plug passes through hole above

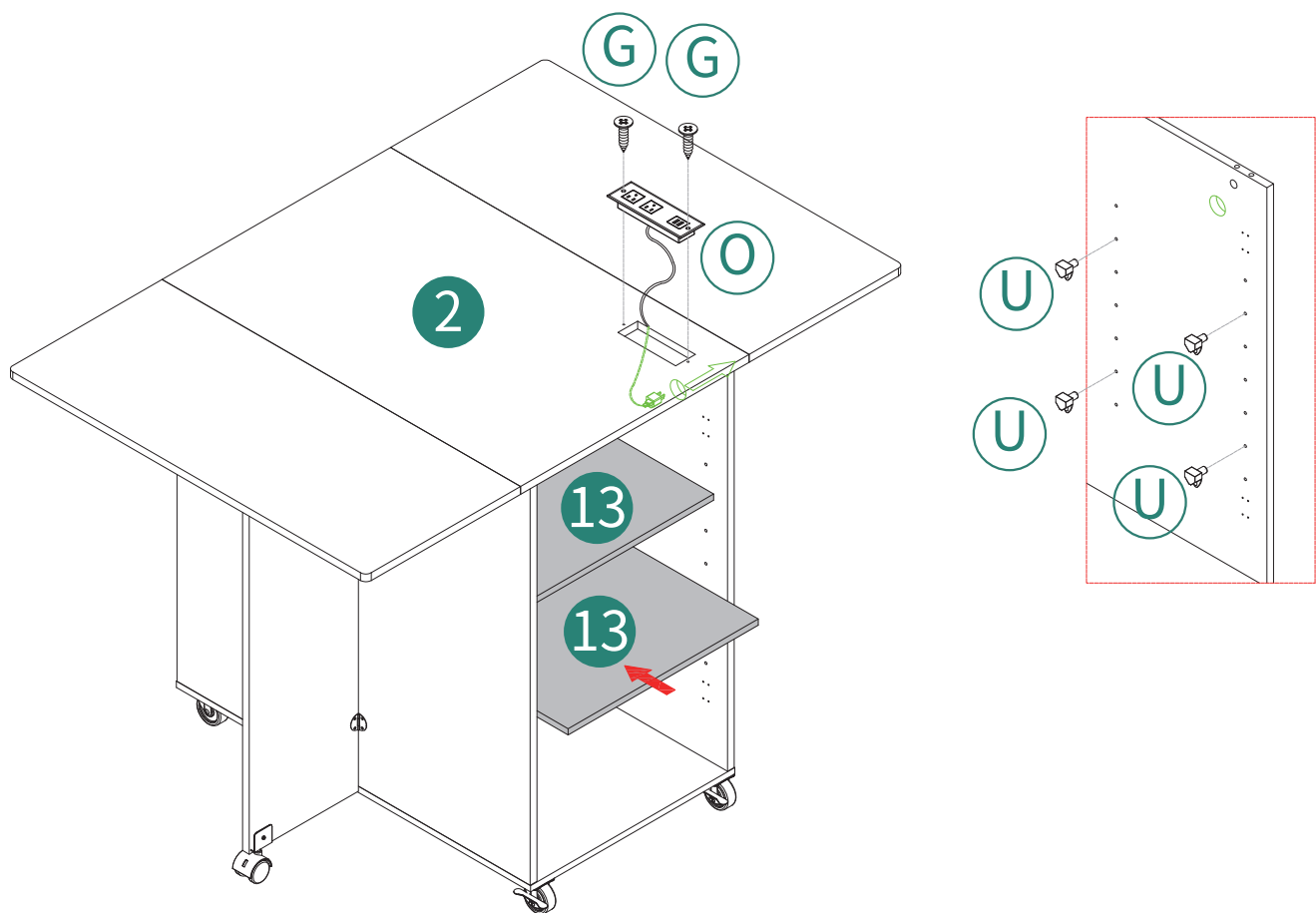

# 16

φ4x15MM

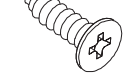

ⓐx4

φ3x12MM

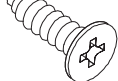

ⓑx2

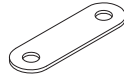

ⓒx1

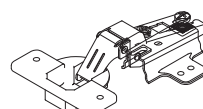

ⓓx2

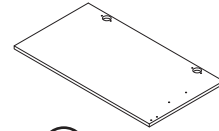

ⓔx1

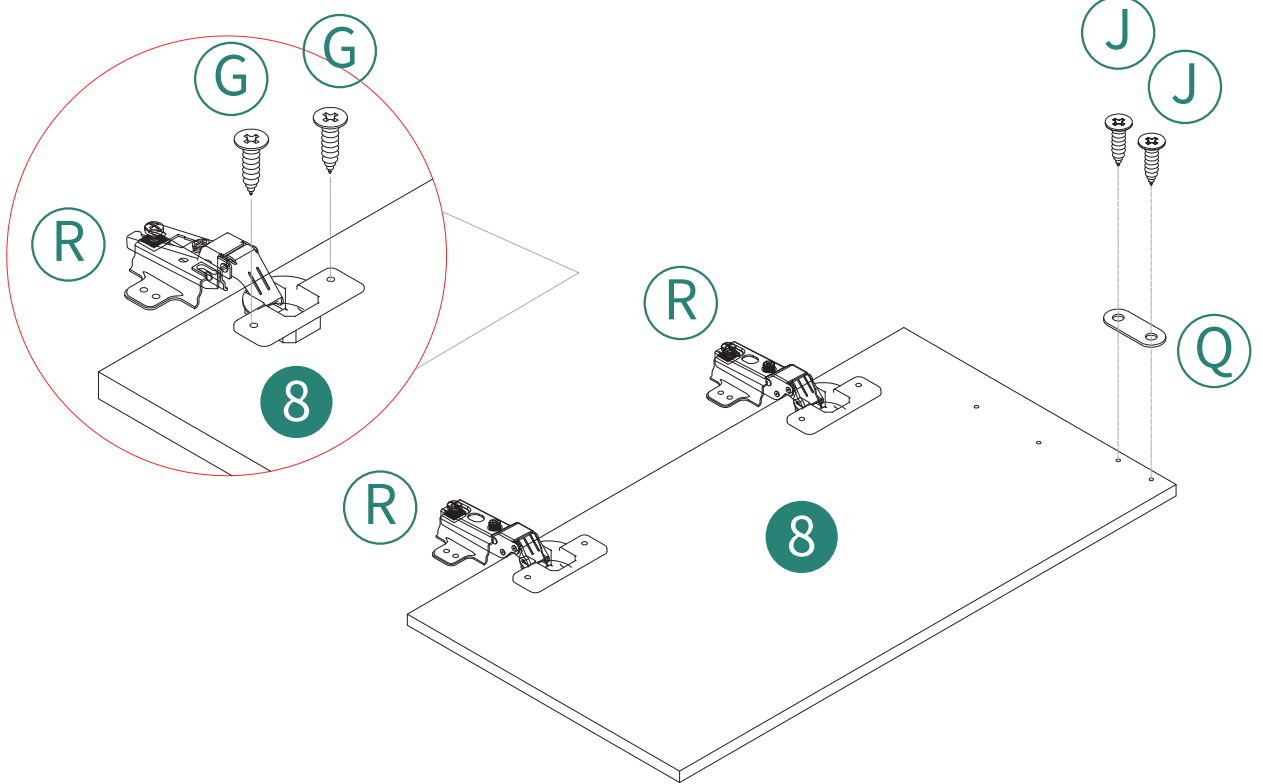

17

φ4x15MM

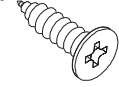

ⓐx8

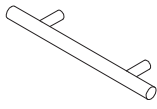

Ⓢx1

φ4x25MM

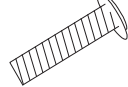

Ⓣx2

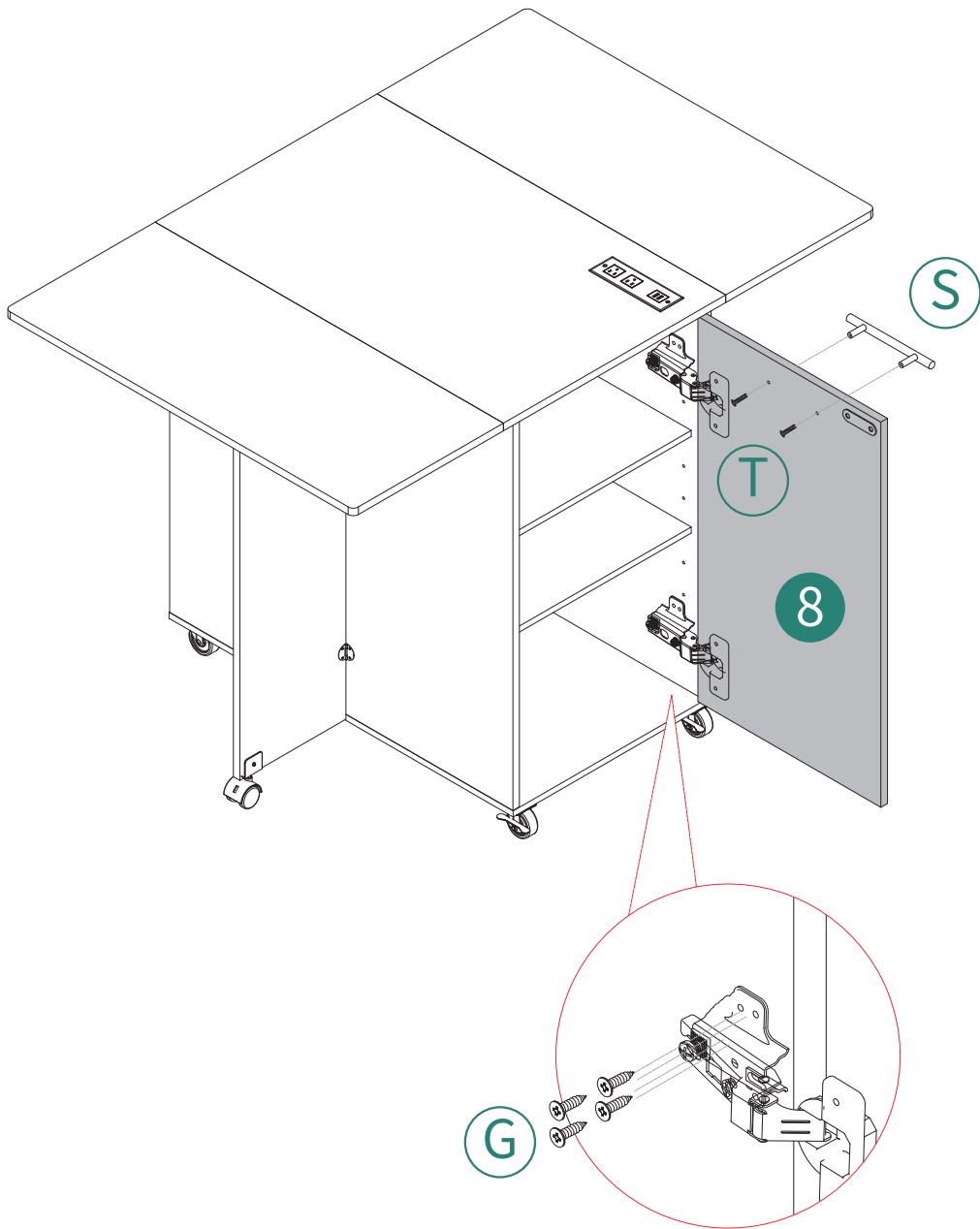

# 18

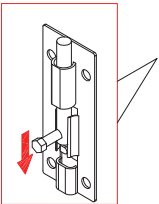
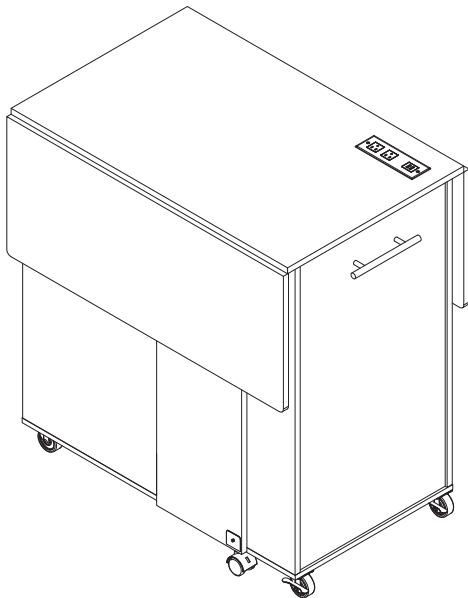

Installation Completed

Installation Abgeschlossen

Installation Complétée

Installazione Completata

Instalación Completada

# HELP CENTER



Inquiry



Assembly issue



Missing parts

If you encounter any difficulties during assembly, please contact us.

Wenn Sie während der Montage auf Schwierigkeiten stoßen, kontaktieren Sie uns bitte.

Si vous rencontrez des difficultés lors du montage, veuillez nous contacter.

Se incontri difficoltà durante il montaggio, ti preghiamo di contattarci.

Si encuentras alguna dificultad durante el ensamblaje, por favor contáctanos.

# DISCLAIMER

Manufacturer and seller expressly disclaim any and all liability for personal injury, property damage or loss, whether direct, indirect, or incidental, resulting from the incorrect attachment, improper use, inadequate maintenance, unapproved modification, or neglect of this product.

Der Hersteller und Verkäufer lehnen ausdrücklich jegliche Haftung für Personenschäden, Sachschäden oder Verluste ab, egal ob direkt, indirekt oder zufällig, die durch falsche Anbringung, unsachgemäßen Gebrauch, unzureichende Wartung, nicht genehmigte Änderungen oder Vernachlässigung dieses Produkts entstehen.

El fabricante y vendedor renuncian expresamente a toda responsabilidad por lesiones personales, daños materiales o pérdidas, ya sean directos, indirectos o incidentales, derivados de la incorrecta colocación, uso inadecuado, mantenimiento insuficiente, modificación no aprobada o negligencia de este producto.

Il produttore e il venditore declinano espressamente ogni responsabilità per lesioni personali, danni materiali o perdite, dirette, indirette o incidentali, derivanti dall'errato fissaggio, uso improprio, manutenzione inadeguata, modifica non autorizzata o negligenza di questo prodotto.

Le fabricant et le vendeur déclinent expressément toute responsabilité en cas de blessures corporelles, de dommages matériels ou de pertes, qu'ils soient directs, indirects ou accessoires, résultant de la fixation incorrecte, de l'utilisation inappropriée, de l'entretien insuffisant, de la modification non approuvée ou de la négligence de ce produit.