

WARNING

**** WE RECOMMEND INSTALLATION OF THIS LIGHTING FIXTURE BE DONE BY A LICENSED ELECTRICIAN ****

- * Switch off the main electrical supply from the main fuse box / circuit breaker before installation.
- * Inspect item carefully before attempting to install.
- * If there is any damages or obvious defects, do not install.
- * Item may not be returned once it has been installed.

CARE AND MAINTENANCE





















- * To clean the outside of the fixture, use a dry or slightly dampened clean cloth (use clean water, never a solvent) to wipe the surface of the fixture.
- * To clean the inside of the fixture, first disconnect power to the fixture by turning off the circuit breaker or by removing the fuse at the fuse box. Next, use a dry or slightly dampened clean cloth (use clean water, never a solvent) to wipe the interior surface of the fixture.
- * Do not use any cleaners with chemical, solvents or harsh abrasives. Use only a dry soft cloth to dust or wipe carefully.

Product Dimensions:19"x19"x23.25"-95.25"

NOTICE& IMPORTANT SAFETY INSTRUCTIONS

- * Please make sure that you have all parts indicated before you begin assembly of this item
 - * This item should be assembled on a soft surface to prevent scratching the finish during assembly
 - * To reduce the risk of fire, electrical shock or injury to persons or property, please follow the guideline below for safe use and installation
 - *The external flexible cable or cord of this lamp cannot be replaced
- If the cord is damaged, the lamp shall be destroyed

Part List and Hardware List

PIECE	DESCRIPTION	PICTURE	QUANTITY	PIECE	DESCRIPTION	PICTURE	QUANTITY	PIECE	DESCRIPTION	PICTURE	QUANTITY
A	Wire Nut		3X	H	Closable link/cap		2X	O	Nipple		1X
B	Mounting Plate		1X	I	Fixture Loop		1X	P	Plastic washer		2X
C	Ground Screw		1X	J	Chain		1X	Q	Diffuser		1X
D	Mounting Screw Size:8/32*30mm		2X	K	Bulb		3X	R	Hex Nut		1X
E	Canopy		1X	L	Lamp Body		1X	S	Metal Cover		1X
F	Hanging Loop		1X	M	Ball Nut		3X	T	Finial		1X
G	Canopy Nut		1X	N	Shade		1X				

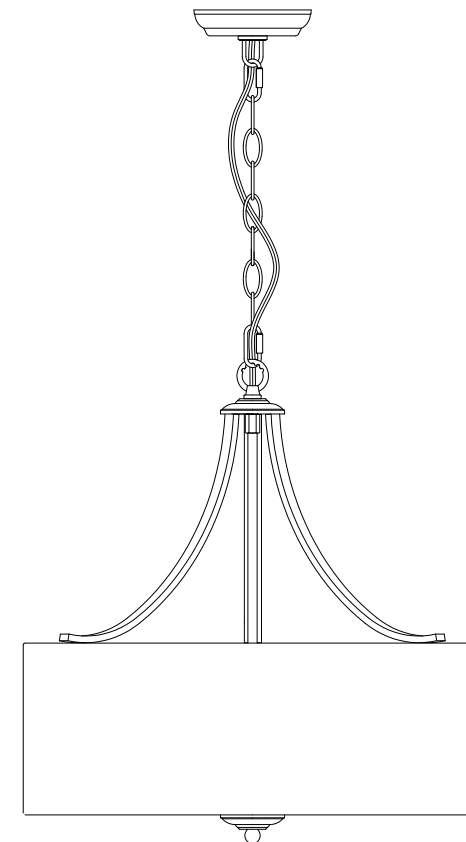

PREPARATION

- * Before beginning assembly of product, make sure all parts are present. Compare parts with package contents list and hardware contents list.
- * If any part is missing or damaged, do not attempt to assemble the product.
- * Estimated Assembly Time:30 minutes
- * If you are having difficulty, our friendly Customer Care team is always here to help. Please email customersupport@safavieh.com

NOTE:PLEASE USE TYPE"A" BULB MAX 60-WATT OR CFL BULB MAX 13-WATT OR LED MAX 9-WATT,THERE ARE 3*9W A19 LED BULBS IN THE BOX.

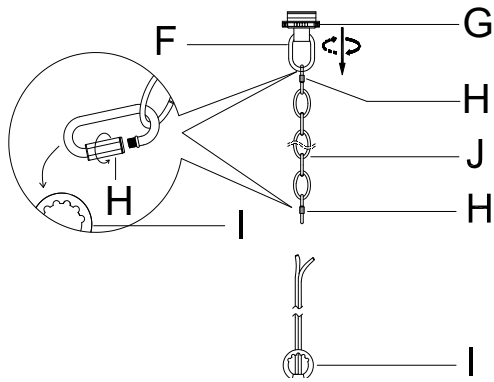

Step 1:Unpack all parts from cartons carefully.Screw the Chain(J) to the Hanging Loop(F) and the Fixture Loop (I) with Closable link/cap (H) as diagram.

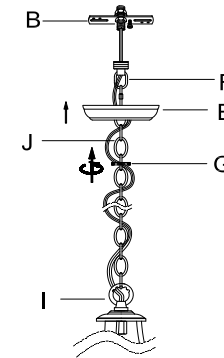

Step 2:Weave the 2 wire power cord and bare ground wire through every other loop to the chain(J),center holes of Hanging Loop(F),Canopy(E)&Mounting Plate(B) as diagram.Slide the Canopy Nut(G) then the Canopy(E) to the end of the Chain(J).

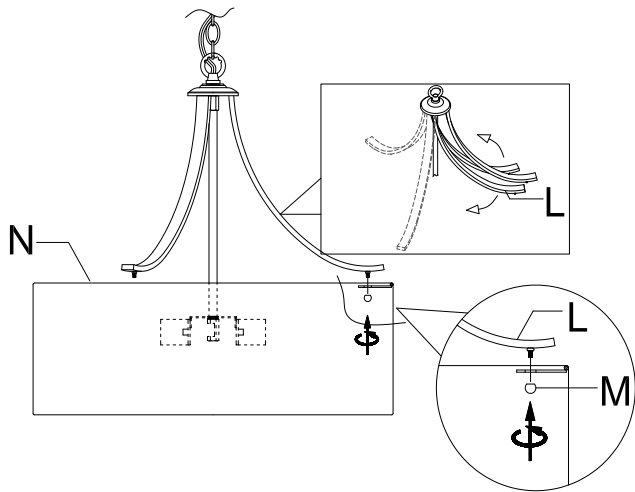

Step 3: Adjust the angle of the spider of the Lamp Body (L).Insert the portion of each spider into the top hollow of the Shade (N), then fix them with Ball Nut (M), tuning each Ball Nut (M) clockwise till tight.

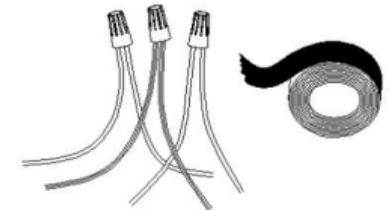
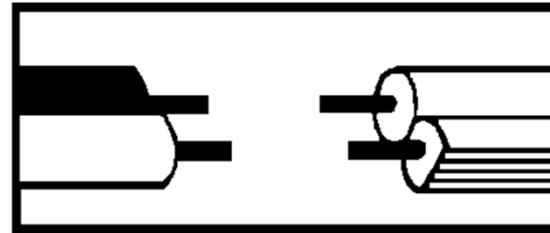

Step 4: Wire connection

Connect fixture neutral wire (ribbed) to the outlet box neutral wire (usually white) using a wire nut.Connect fixture hot wire (smooth with markings) to the outlet box hot wire (usually black) using a wire nut. CAUTION: Do not reverse the hot and neutral connections

Grounding Instructions:

Wrap ground wire from outlet box around green ground screw(B) on mounting bracket, no less than 2" from wire end. Tighten ground screw. If fixture is supplied with a ground wire, connect to outlet ground wire with a wire connector.

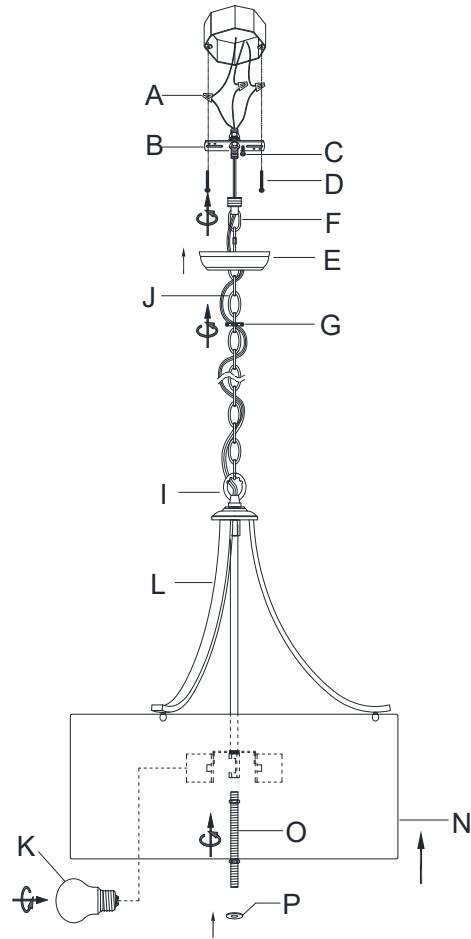

Step 5: Attach the Mounting Plate (B) onto the junction box with two Mounting Screws (D). Slide the Canopy (E) upward along the chain (J) till the ceiling surface. Fix it by rotating the Canopy Nut (G) clockwise to engage it with the threaded portion of the Hanging Loop (F) until secure. Do not over tighten this nut. Insert the bulbs (K) into the sockets until secure.
DO NOT EXCEED THE SPECIFIED WATTAGE.

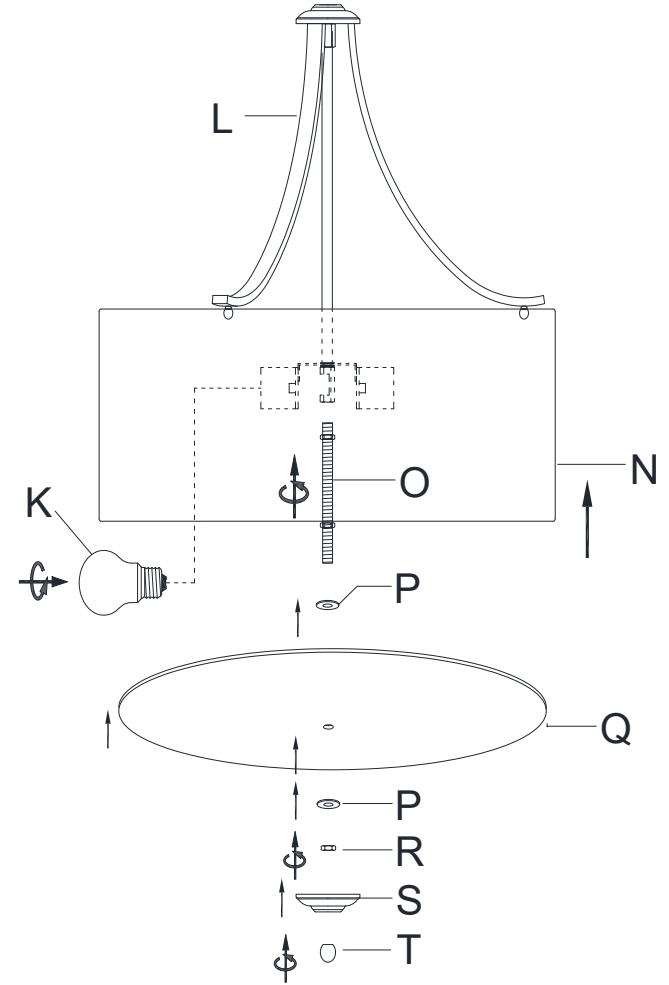

Step 6: Screw the Threaded Stem (O) into the tube underneath of the socket assembly as diagram. Place the Plastic washer (P) onto the Threaded Stem (O) then the Diffuser (Q), Plastic washer (P). Fix them with Hex Nut (R). Attach the Metal Cover (S), fix it with Finial (T).