

# ASSEMBLY INSTRUCTIONS

## Tufted Bucket Seat Dining Chair (Set of 2)

ASSEMBLY  
REQUIREMENTS

1-Person  
Assembly

30 Minutes  
Assembly Time  
(Approximate)



### Thank you for purchasing our product!

Please refer and use this assembly instruction to assemble the product. Contact our customer service department in case there are any missing or damage parts or hardware. Replacement parts are normally shipped within 2 or 3 days.

We appreciate your business!

### ASSEMBLY PREPARATION

1. Remove all packaging materials, staples and packing straps from the carton.
2. Refer to Parts List and Hardware List, and ensure parts and hardware are correct before assembly. Contact customer service for missing parts.
3. Place all wooden parts on a clean, flat and soft surface (e.g. carpet or rug) to prevent scratch and damage to parts.

### SAFETY PRECAUTION

1. KEEP ALL HARDWARE PARTS OUT OF REACH OF CHILDREN.
2. DISPOSE PLASTIC PACKAGING MATERIAL IMMEDIATELY TO AVOID ANY RISK OF SUFFOCATION TO CHILDREN AND ANIMALS.

### TIPS FOR ASSEMBLY

1. Allow ample room for assembly and in close proximity to where product will be placed.
2. Assemble the product on a surface that does not scratch or damage the exterior gloss and finish of the furniture.
3. Identify all of the parts, hardware and quantities required for each step.
4. During assembly, do not over-tighten any fittings as this may cause damage.
5. DO NOT USE POWER TOOLS TO ASSEMBLE THIS PRODUCT.
6. Always place the product on a flat, level surface.
7. Do not sit or stand on the partially assembled product; only use the product for which it is intended.

### CARE AND MAINTENANCE





- Use a slightly damp cloth to clean the product. Do not use bleach or abrasive cleaning material.
- Check all the fittings periodically and re-tighten as necessary. Do not use the product if any of the parts is damaged or broken.
- Never allow any kind of liquid to remain on your furniture. Absorption can cause wood to warp or delaminate.
- Do not place hot items (e.g. hot drinks) directly onto the wood surface.
- Do not drag and/or pull the furniture.

This product is for indoor and household use only - not for commercial use.



# ASSEMBLY INSTRUCTIONS

## Tufted Bucket Seat Dining Chair (Set of 2)

### Hardware List (for 1 Unit)

Item	Description	Part	Qty	Item	Description	Part	Qty
A	Plastic Saddle Washer		2	B	Allen Head Bolt 6*35mm		2
C	Allen Head Bolt 6*30mm		2	D	Flat Washer 6*16mm		4
E	Allen Key		8				

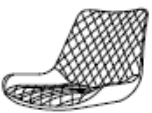
### Parts List (for 1 Unit)

Item	Description	Part	Qty	Item	Description	Part	Qty
1	Chair Back & Seat		1	2	Chair Leg		1

### Parts Assembly Overview

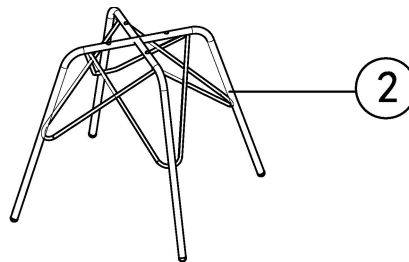
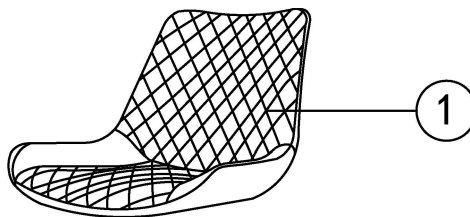

# ASSEMBLY INSTRUCTIONS

## Tufted Bucket Seat Dining Chair

### STEP 1

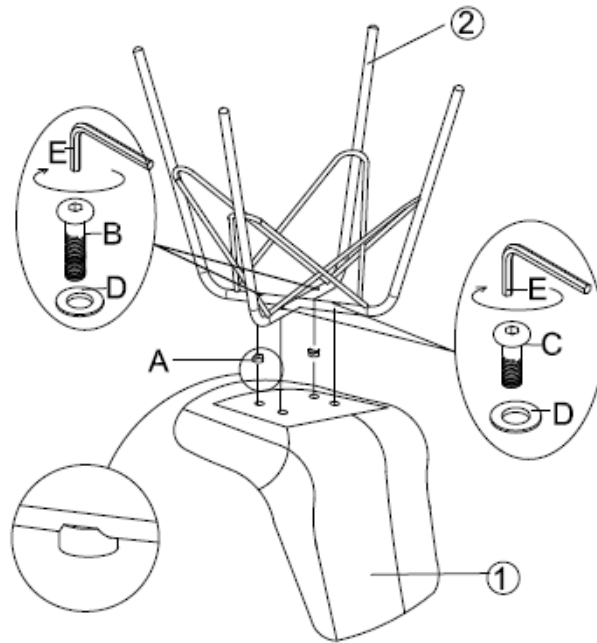

A		2 pcs
B		2 pcs
C		2 pcs
D		4 pcs
E		1 pc

- a) Place Chair Back & Seat (1) as shown on elevated surface (e.g. table top) and position the bolt holes on Chair Leg (2) to align to the bolt holes on (1).
- b) Place Plastic Saddle Washer (A) between (1) and (2) on the front 2 bolt holes of (2).
- c) Use the longer Bolt (B) fitted with Flat Washer (D) to fasten the Chair Leg to the front bolt holes that have the Saddle Washer and use the shorter Bolt (C) fitted with Flat Washer (D) to fasten the Chair Leg to the rear bolt holes.
- d) Use Allen Key (E) to drive (B) & (C). Do not tighten (B) & (C) completely until all 4 bolts are in place.

### STEP 2



Set the Chair right-side up.

The assembly of the chair is complete