

Step 1

Ⓜx16 Ⓛx6 Ⓧx4

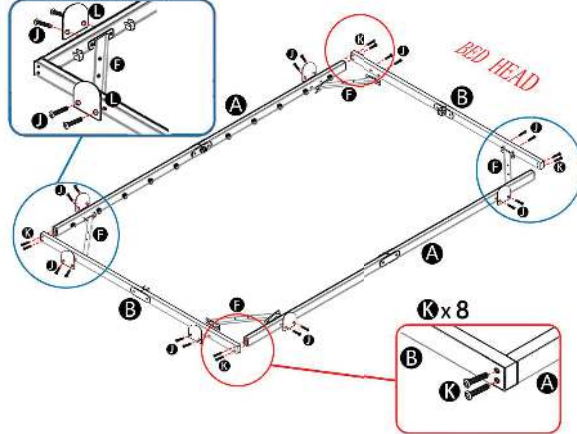

Step 2

Ⓜx2

Ⓜx2

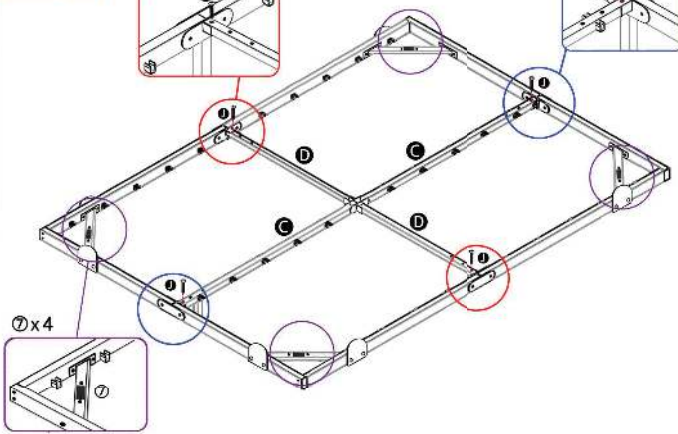

Step 3

Ⓜx8 Ⓧx4

Ⓜx4 Ⓧx2 Ⓧx2 Ⓜx1

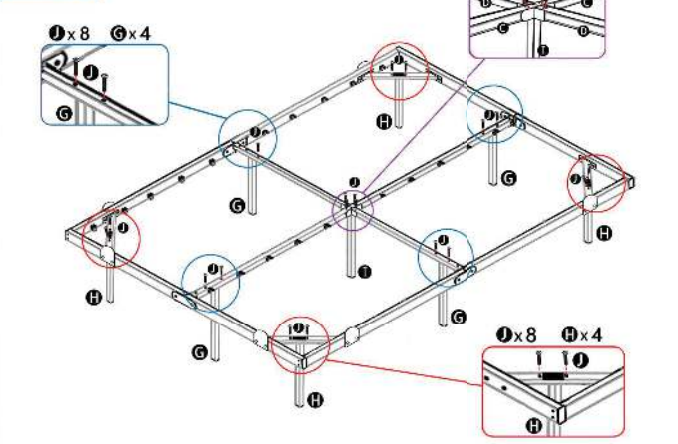

Step 4

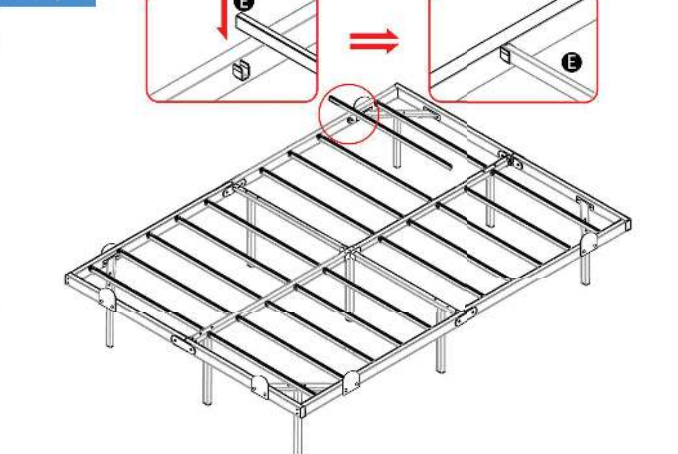

Ⓧx20

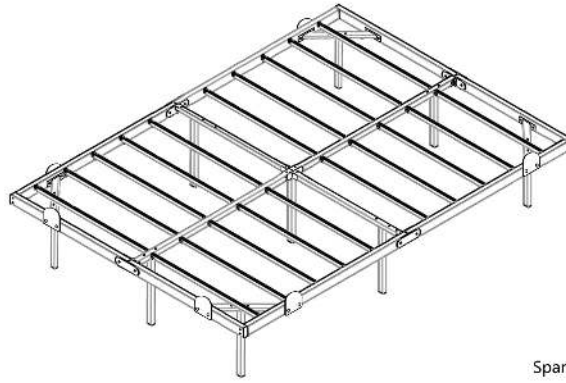

Platform Bed (F/Q/K) SET-UP INSTRUCTION















Spare screws

-  short bolt X 1 pc
-  long bolt X 1 pc

Note:







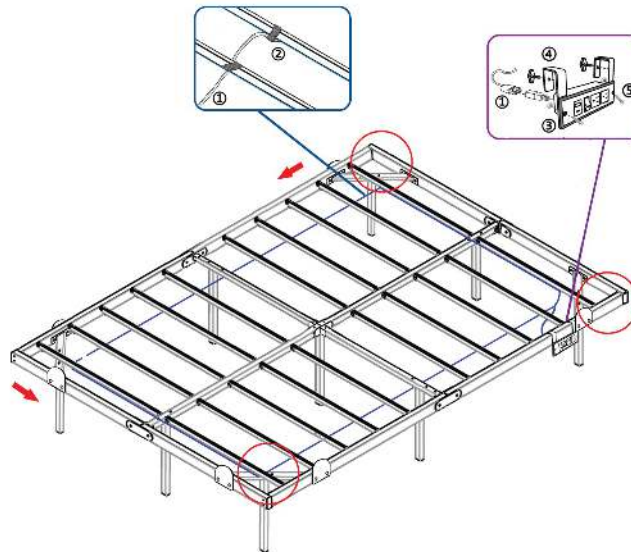

Please insert all bolts into their respective holes and turn the bolts by hand just enough to hold them in place, avoiding full tightness. Once all bolts are positioned, secure them firmly. This approach to aligning and initially securing the bolts ensures a snug fit, thereby enhancing the overall stability of the bed frame.

 A X 2 pcs	 B X 2 pcs	 C X 2 pcs	 D X 2 pcs	 E X 20 pcs
 F X 4 pcs	 G X 4 pcs	 H X 4 pcs	 I X 1 pc	 M8*35mm J X 40 pcs
			 M8*45mm K X 8 pcs	 L X 6 pcs
				 M 1pc

LED light installation



There is a QR code on the USB plug of the LED light. Scan the code to download the app and experience more features.

 RGB soft light strip 1 1PC	 Velcro 2 20PCS	 3 1PC	 4 2PCS
 5 2PCS	 6 1PC	 Cushion pads (prevent friction noise) 7 4PCS	 8 1PC