

ASSEMBLE INSTRUCTION

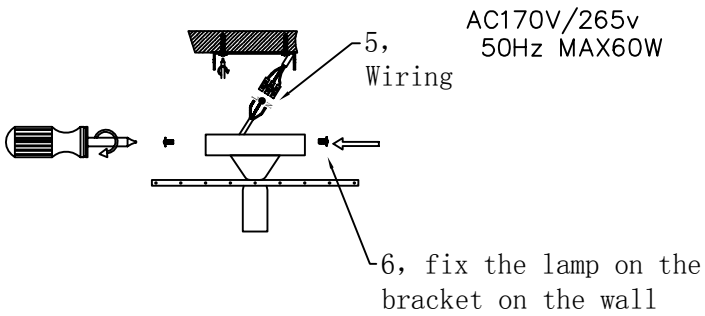

AC170V/265v
50Hz MAX60W

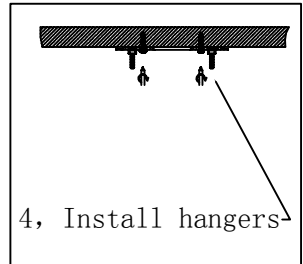
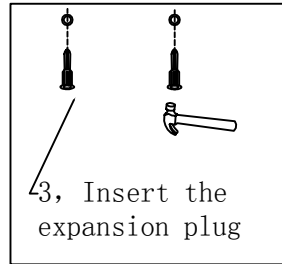
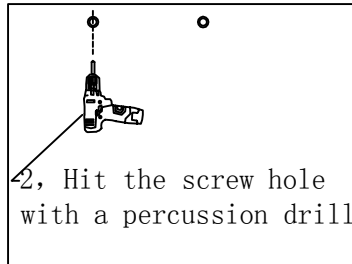
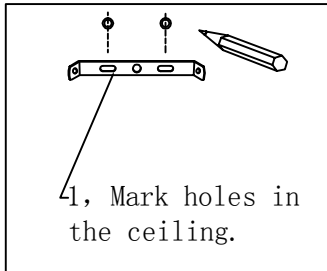
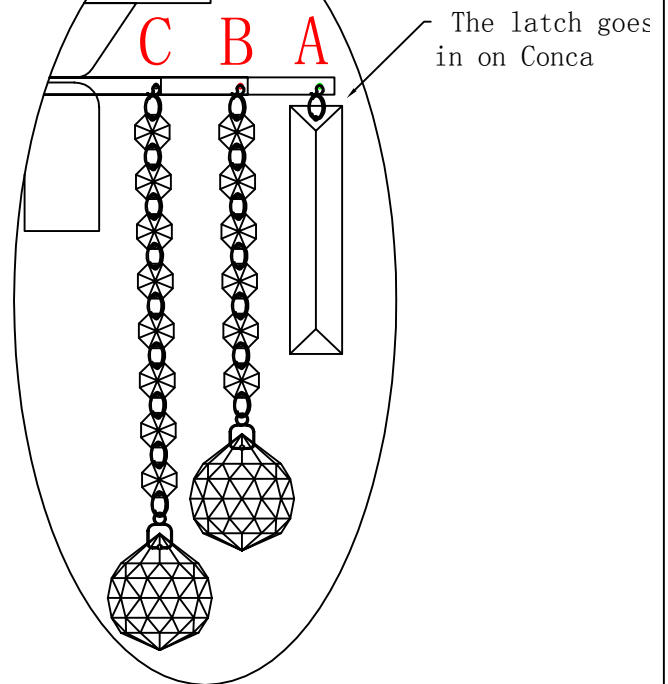
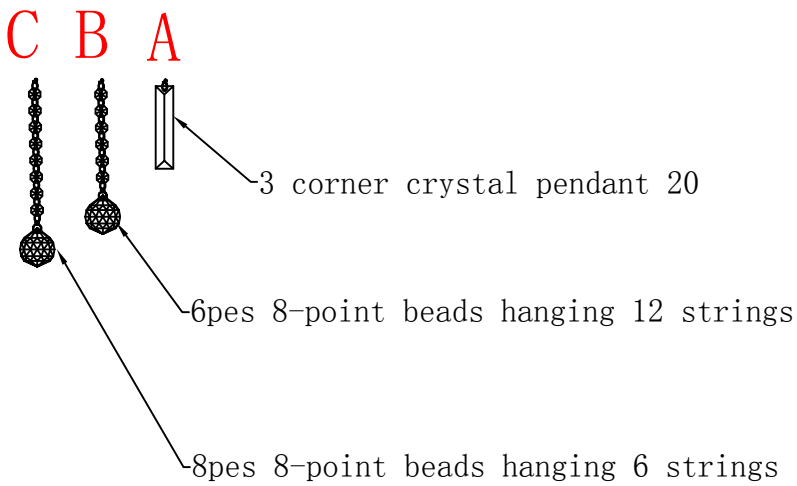
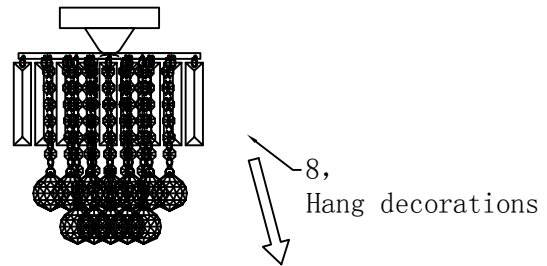
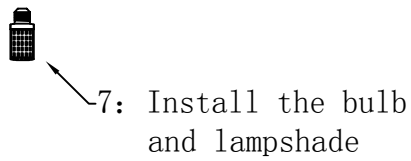

Install Steps:

1, Mark holes in the ceiling.

2, Hit the screw hole with a percussion drill

3, Insert the expansion plug

4, Install hangers

5, Wiring

6, fix the lamp on the bracket on the wall

7, Install the bulb

8, Hang decorations