

ASSEMBLY INSTRUCTIONS

Functional Recliner Chair

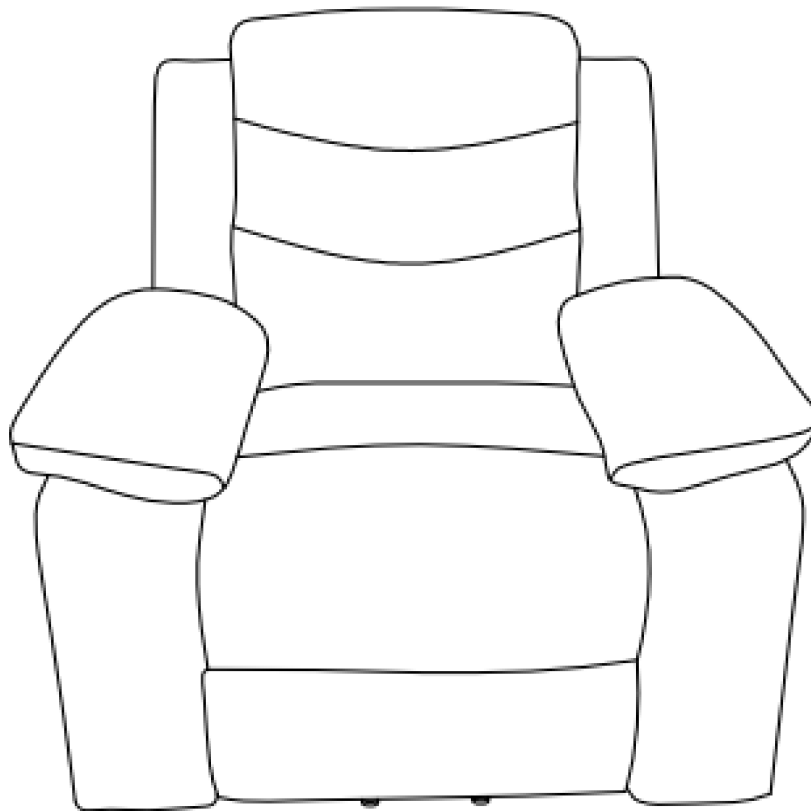



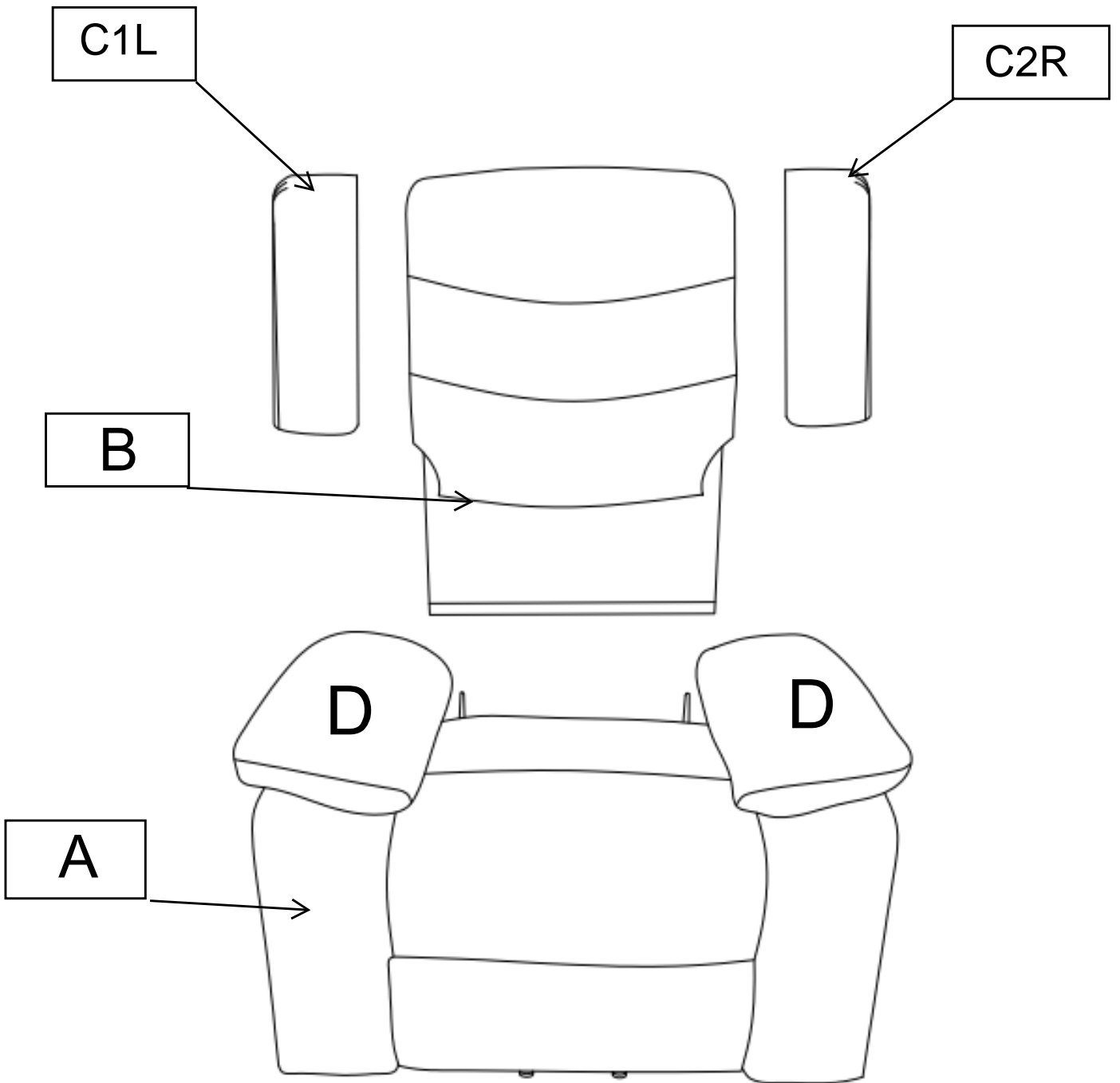

IMPORTANT NOTE:

- ① PLACE ALL PARTS ON A CLEAN AND SMOOTH SURFACE SUCH AS A RUG OR CARPET TO AVOID THE PARTS FROM BEING SCRATCHED.
- ② BEFORE YOU BEGIN, KINDLY FOLLOW THE ASSEMBLY INSTRUCTIONS STEP BY STEP.

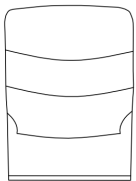

Part List

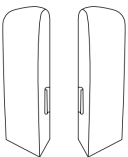
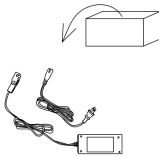
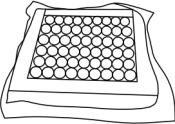
<p>Ⓐ</p> 	<p>Ⓓ</p> 
<p>SEAT (1 PC)</p>	<p>ARM CUSHION (2 PCS)</p>
<p>Ⓑ</p> 	<p>Ⓔ</p> 
<p>BACKREST (1 PC)</p>	<p>SWITCH (1 PC)</p>
<p>Ⓒ</p>  <p>C1L C2R</p>	<p>Ⓕ</p> 
<p>EARREST (2 PCS)</p>	<p>POWER LINE (2 PCS)</p>
	<p>Ⓖ</p>  <p>S-SPRING POCKET (1 PC)</p>

STEP 1:

Warning: Please be careful when cutting the wrapping tape!!!

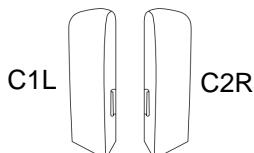
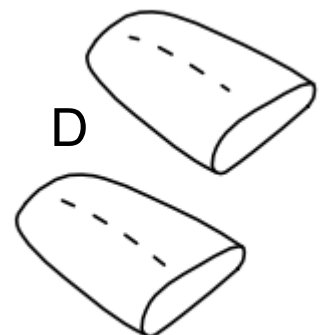
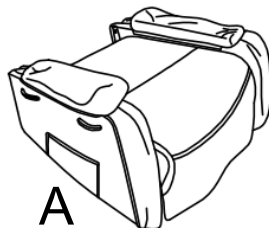
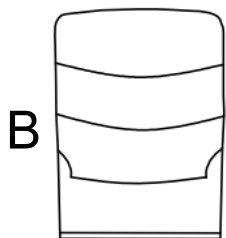
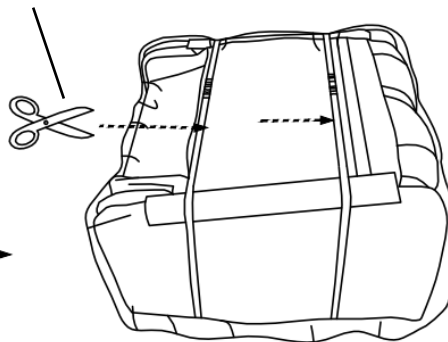
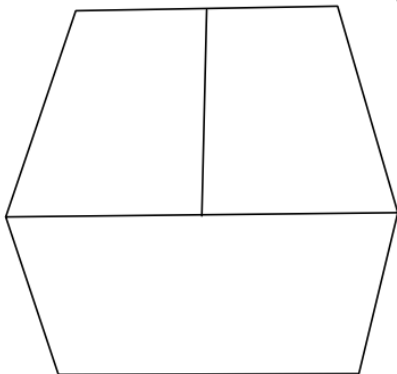

STEP 2:

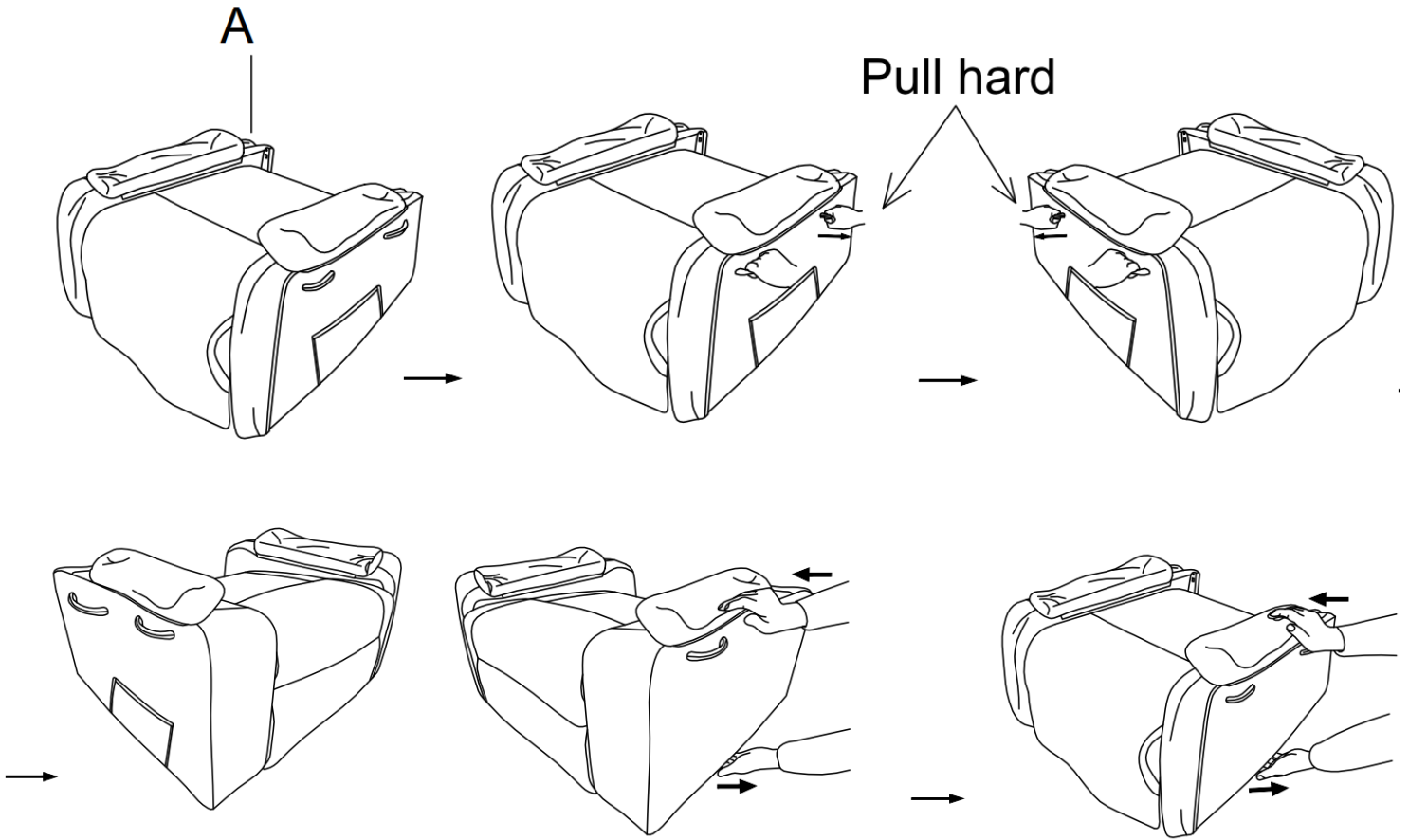

STEP 3:

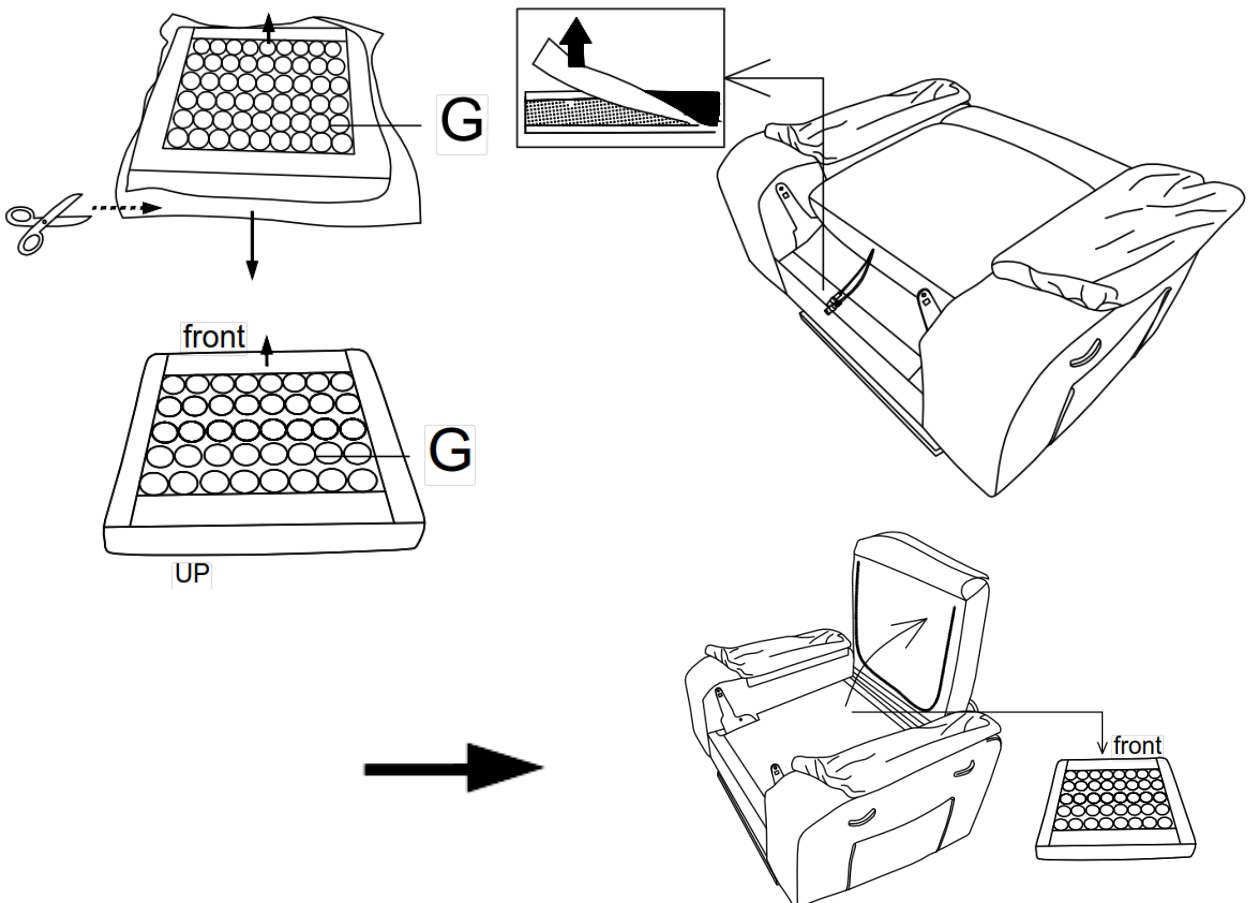

STEP 4:

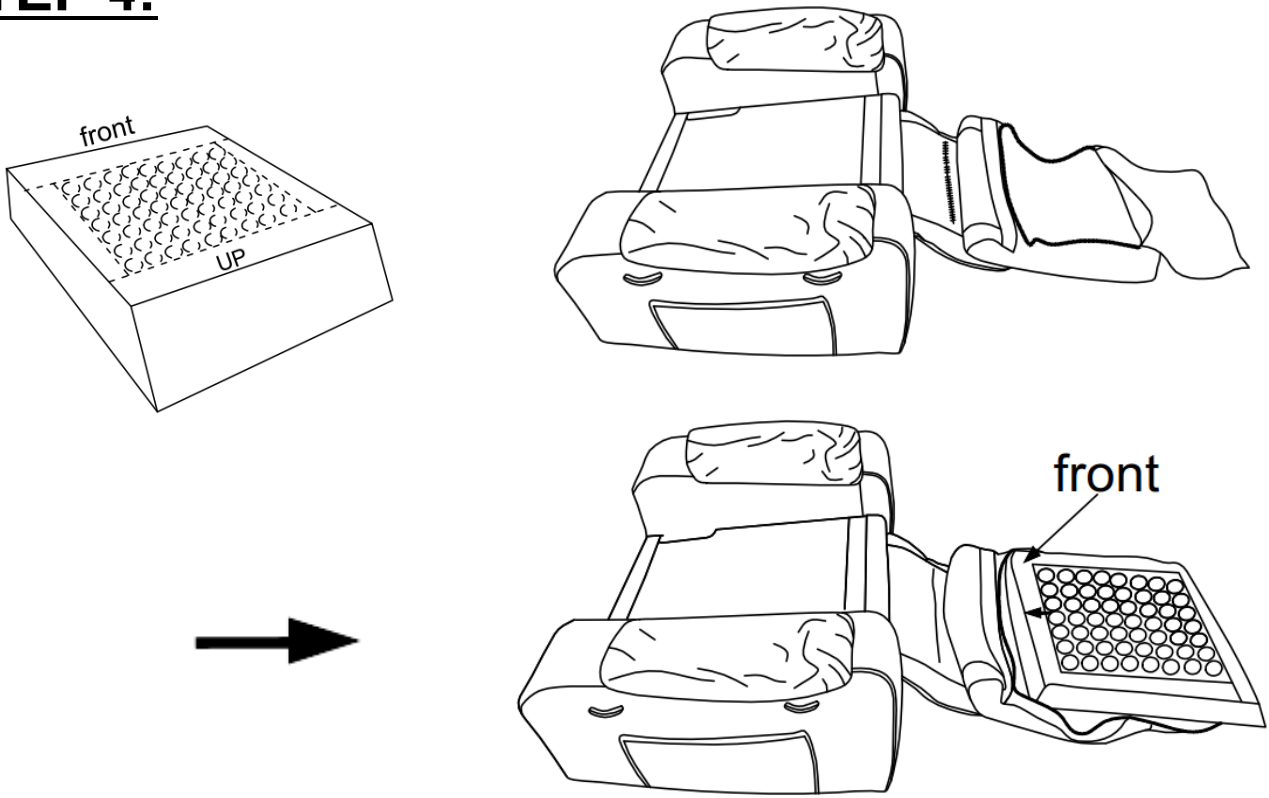

STEP 5:

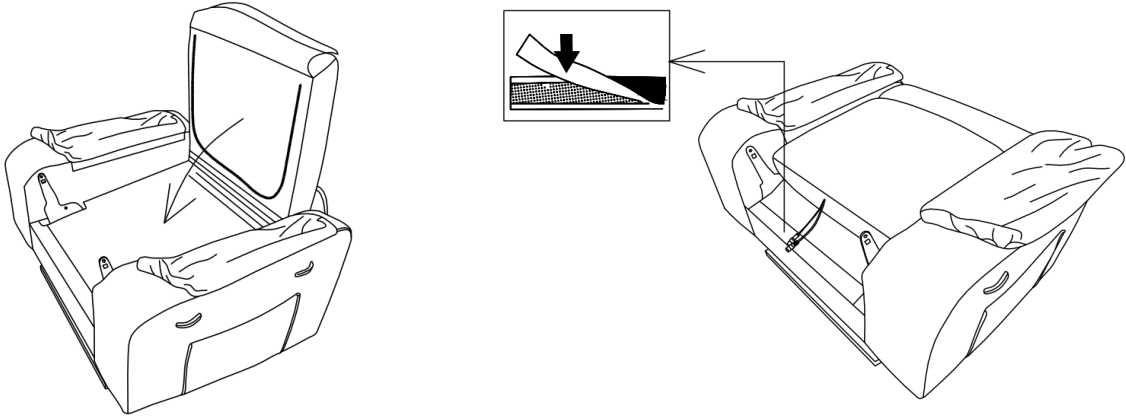

STEP 6:

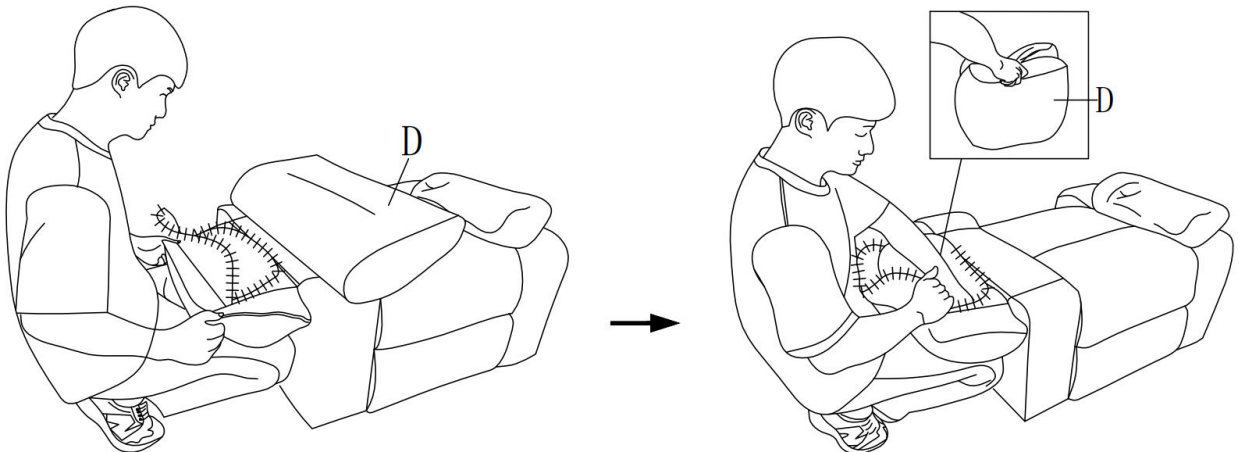

STEP 7:

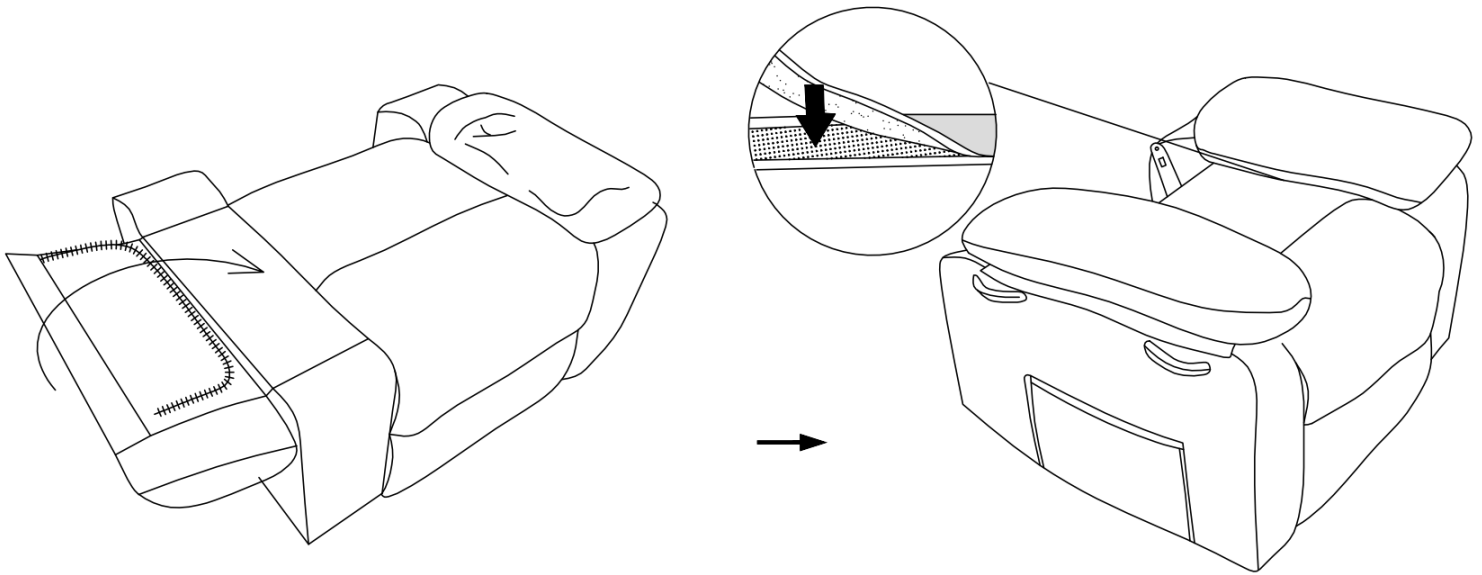

STEP 8:

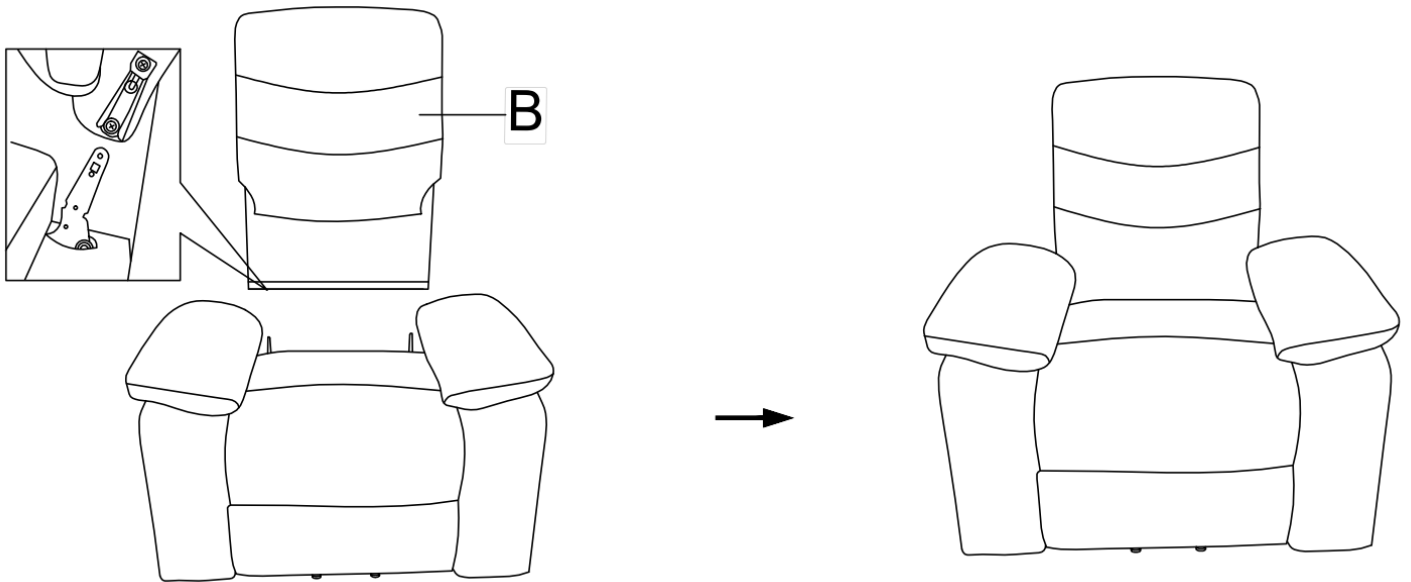

STEP 9:

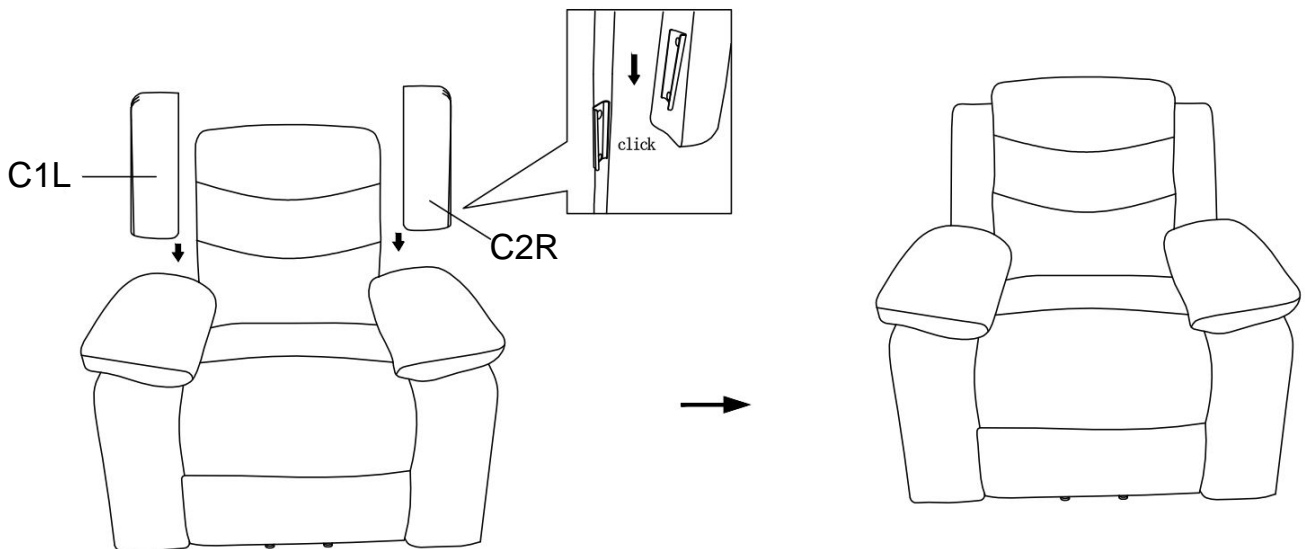

STEP 10:

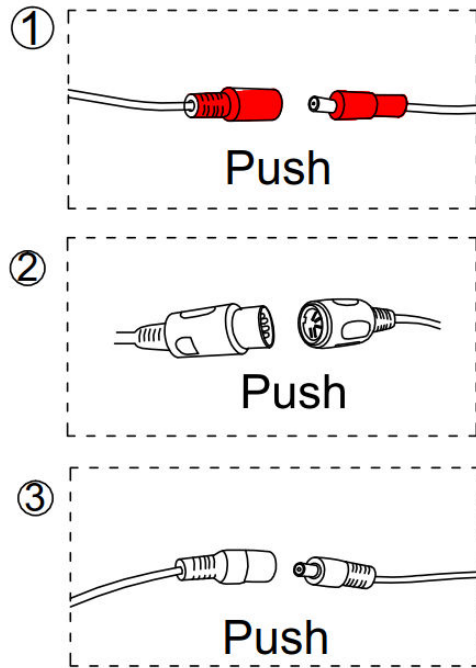
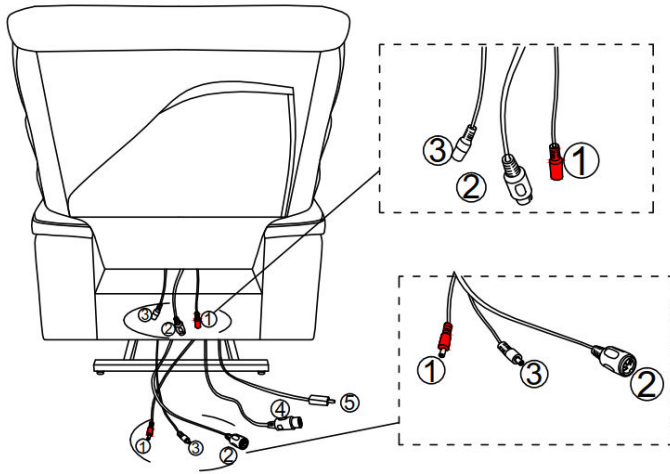

STEP 11:

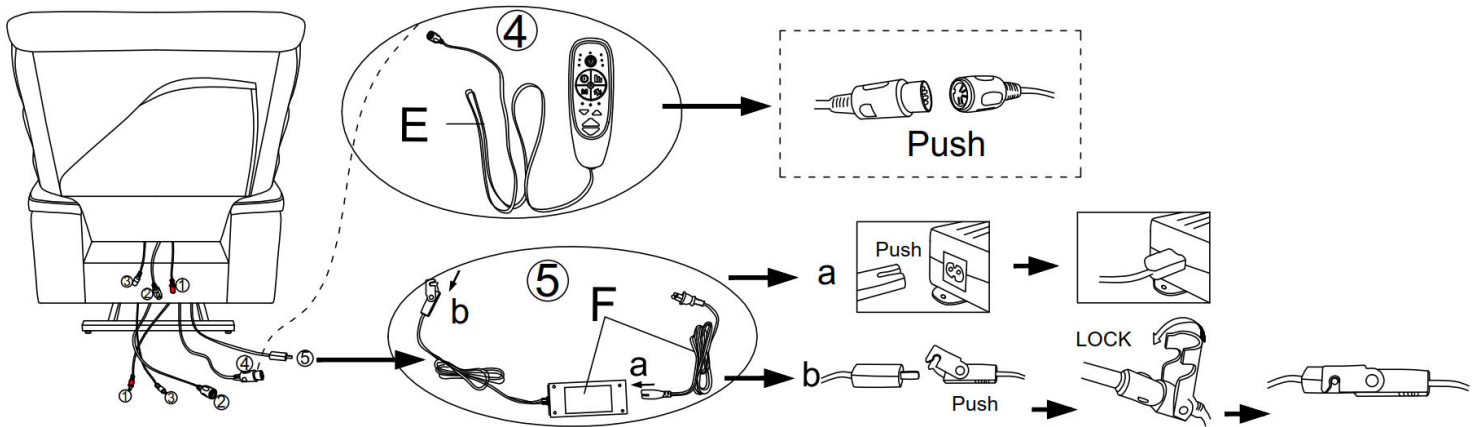

STEP 12:

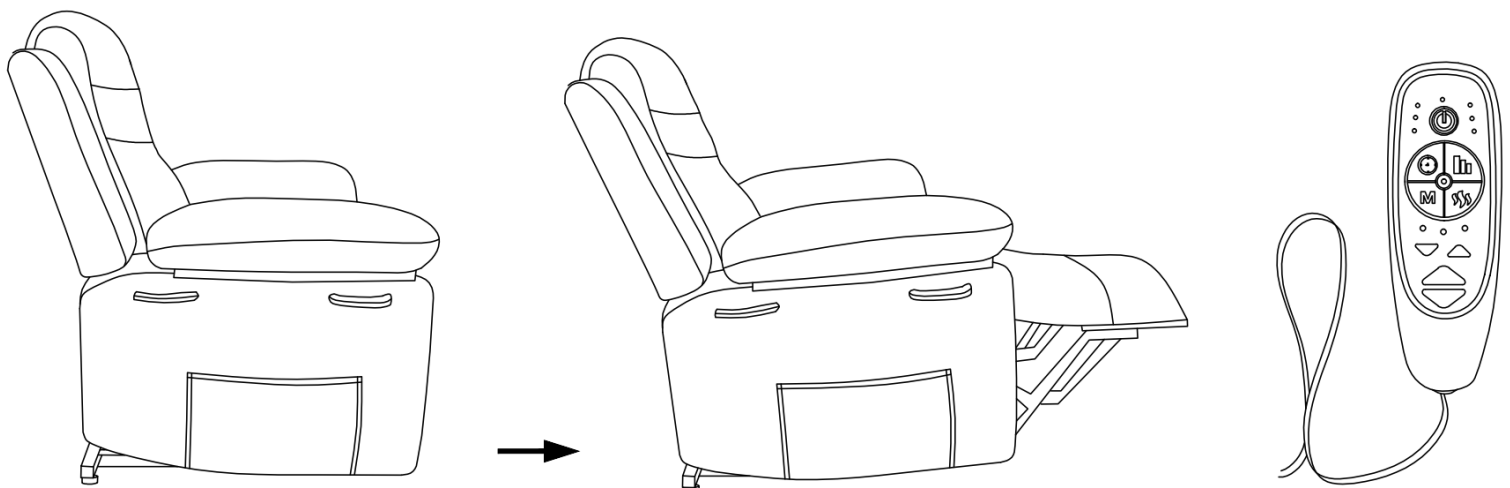

COMPLETED :

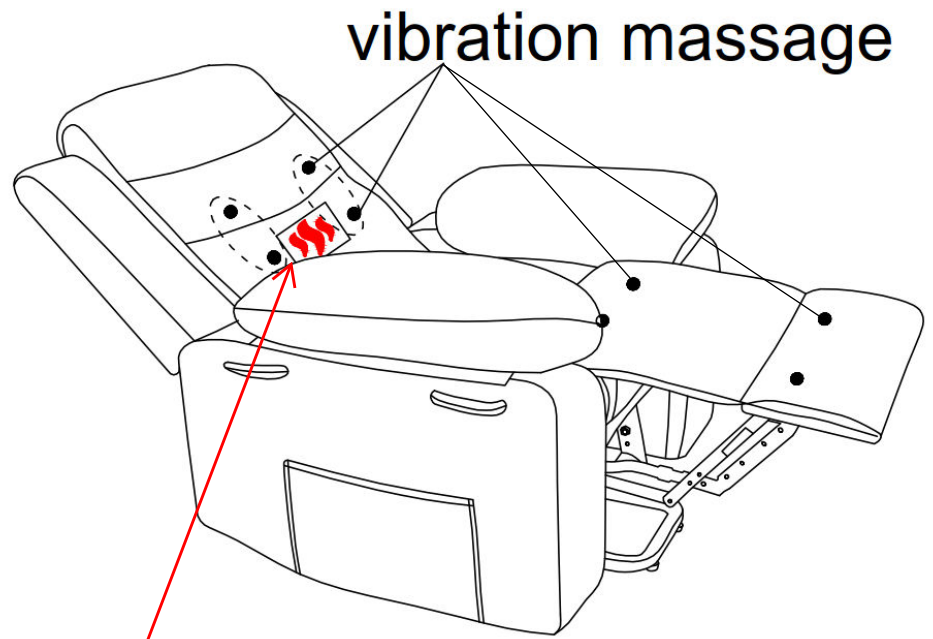
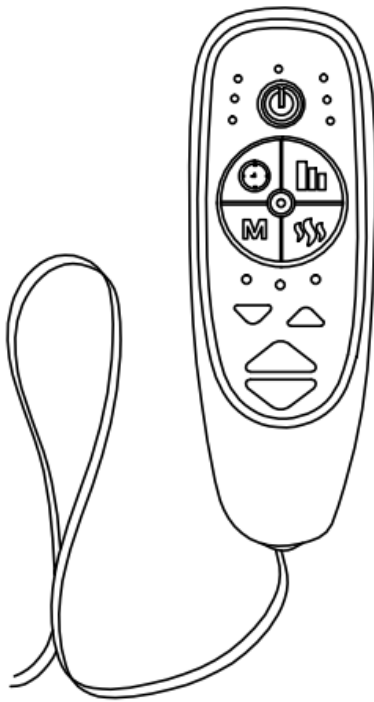

**Heating
function**