

Manual Book

Wall-Sconce

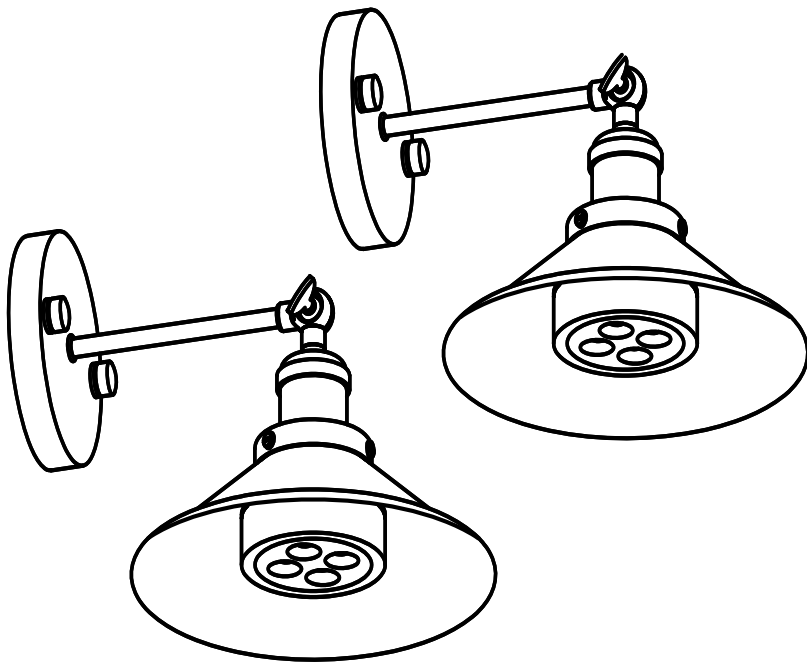

Safety Rules

WARNING: BE SURE THE ELECTRICITY TO THE WIRES YOU ARE WORKING ON IS SHUT OFF; EITHER THE FUSE IS REMOVED OR THE CIRCUIT BREAKER IS TURNED OFF. TURNING THE POWER OFF USING THE LIGHT SWITCH IS NOT SUFFICIENT TO PREVENT ELECTRICAL SHOCK.

NOTE: The important safeguards and instructions appearing in this manual are not meant to cover all possible conditions or situations that may occur. It must be understood that common sense, caution, and care, are factors which cannot be built into any product. These factors must be supplied by the person(s) installing this unit.

READ & SAVE THESE INSTRUCTIONS

CAUTION: Before assembling the lighting fixture, please read the following chapters. If you feel you do not have enough electrical wiring experience, either refer to a do-it-yourself wiring handbook or have your lighting fixture installed by a qualified, licensed electrician. Remove the fixture and the mounting packages from the box and make sure that no parts are missing by referencing the illustrations on the installation instructions.

Be sure to read these installation instructions and review the diagrams thoroughly before installation.

LIGHT BULBS REQUIRED

This fixture uses E26 bulb base, works with incandescent, LED, CFL, halogen or color changing bulbs up to 60W. Fully dimmable when used with dimmable bulbs and a compatible dimmer switch (not included).

1. Installation Preparation (Tools You Need)



Ladder

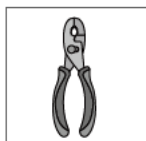

Pliers

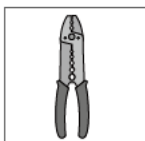

Wire Strippers

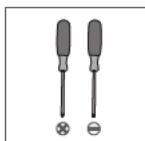

Screwdrivers

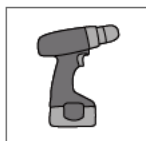

Power Drill (optional)



Drill Bit (optional)

2. Installation Kit

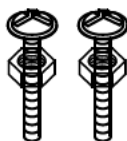

AA



BB



CC

DD



EE



FF



GG

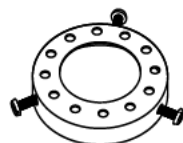

HH

Part	Description	Quantity
AA	Canopy Screw with Nut	2
BB	Wire Nut	3
CC	Pair of Gloves	1
DD	Cap Nut	2
EE	Hex Nut	1
FF	Wood Screw (Wiring-free Installation)	2
GG	Ground Wire	1
HH	Fixed Cover (with Three Screws)	1

Note: Some extra hardware may be included. The quantity listed above is the number required for installation.

3. Assemble the Lamp

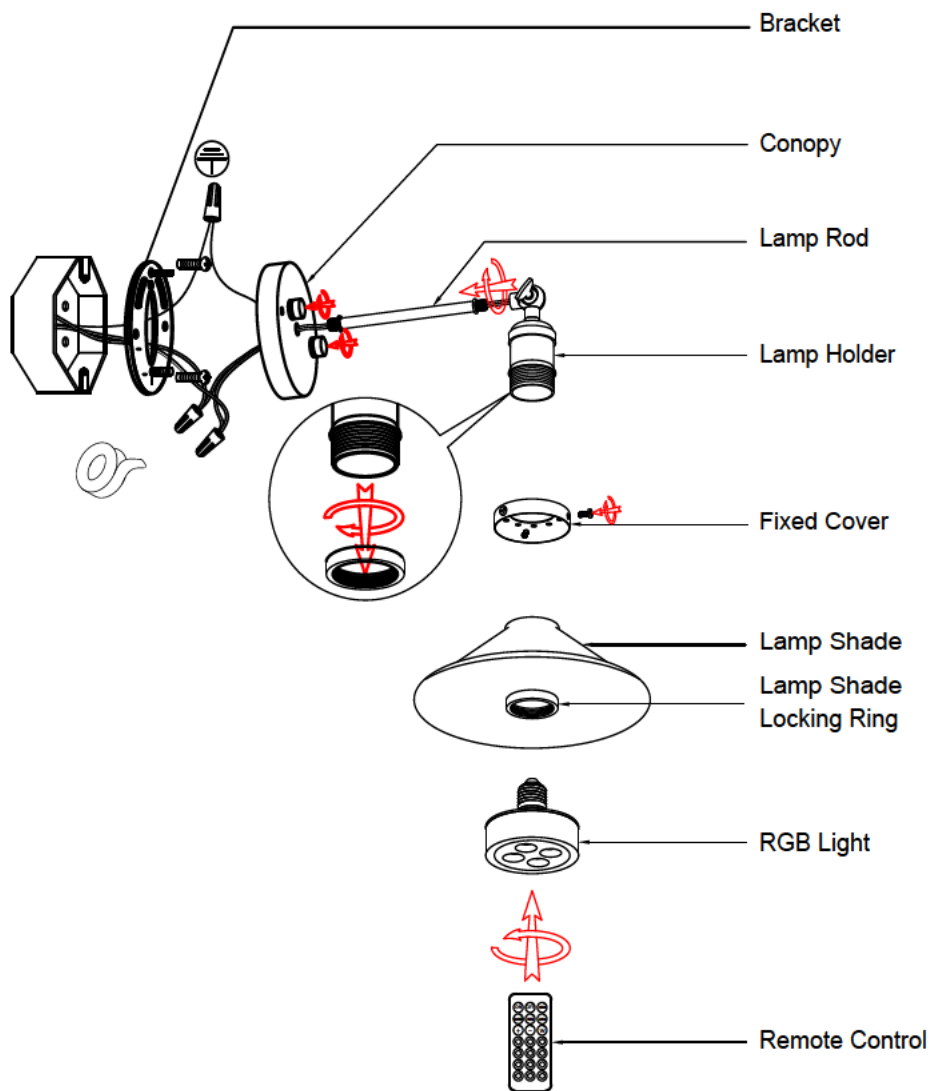

4. Mounting Option-1 (Hardwired)

Note: Please test the fixture before installation to ensure it is working properly.

1. Turn off power at circuit box to avoid possible electric shock.
2. Attach the bracket to junction box using mounting screws (Not included) ①.
3. Connect fixture wires ③ to house wires with plastic wire connectors.
4. Attach Canopy to the affixed Mounting Plate ① using cap nut ④.

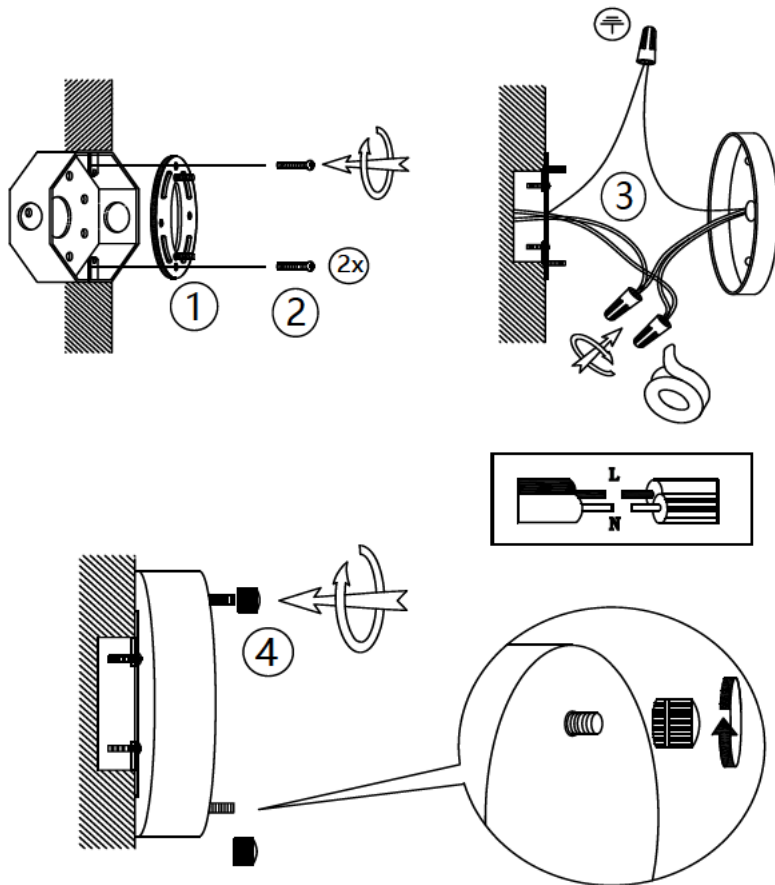

5. Remote Control

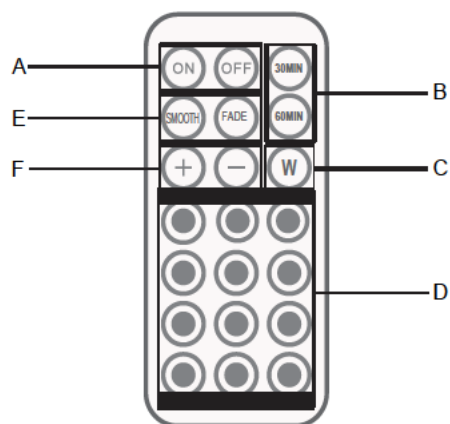

Part	Description	Part	Description
A	Turn ON/OFF the Light	D	RGB Light
B	Timing the Light	E	Mode Switch
C	Natural Light	F	Adjust Brightness

6. Assemble the Bulb

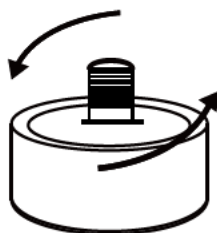

Turn the top cover counterclockwise and open the bulb

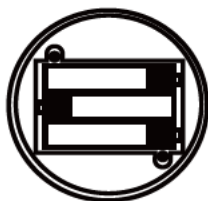

Install three 1.5V AA batteries (not included, it is recommended to use rechargeable batteries)

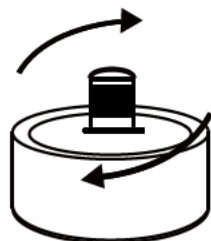

Rotate the top cover clockwise and lock it tightly

Trouble Shooting

1. Missing/Broken Parts

- Make a list of the missing/broken parts according to the packing list, take photos for broken parts, then email us for free replacements.

2. Bulbs Do Not Light Up

- Check your power and switch to make sure it's power on.
- Check the bulb to make sure it's installed correctly.
- Change a new bulb.
- Check the wires to make sure they are connected correctly.

3. Bulbs Flicker/Noisy Operation

- Check the bulb to make sure it's installed correctly.
- Change a new bulb.
- Make sure your bulb is dimmable if you use a dimmer switch.

4. Could Not Install/Assemble

- Take photos of the ceiling/fixture, contact seller for technical support.

Clean And Care

To clean, wipe fixture with soft cloth. Spray from chemical cleaners can discolor the finish of fixture. Do not use scouring pads, powders, steel wool or abrasive paper to clean this fixture.

Ordering Parts

Keep this manual for future reference, and in case replacement parts are needed. Available parts can be ordered from place of purchase. Use exact wording from diagrams when ordering parts.