

IMPORTANT, RETAIN FOR FUTURE REFERENCE: READ CAREFULLY

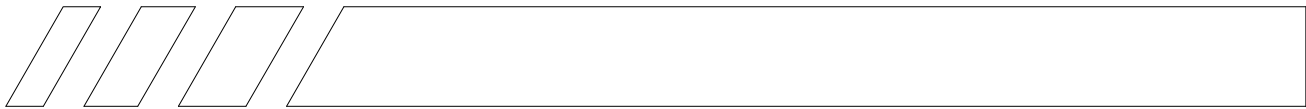

①



1PCS

②



1PCS

③



1PCS

④

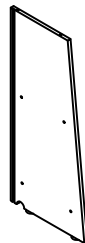

1PCS

⑤



1PCS

⑥



1PCS

⑦



1PCS

⑧

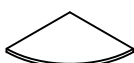

1PCS

⑨

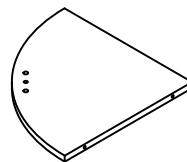

1PCS

⑩



1PCS

A

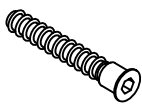

M7\*38

22PCS

B

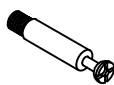

10PCS

C



10PCS

D



M8\*30

3PCS

E



1PCS

F

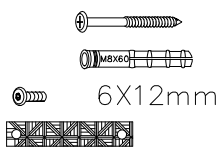

6X12mm

1PCS

G

G1



G2



1PCS

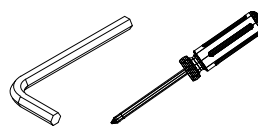

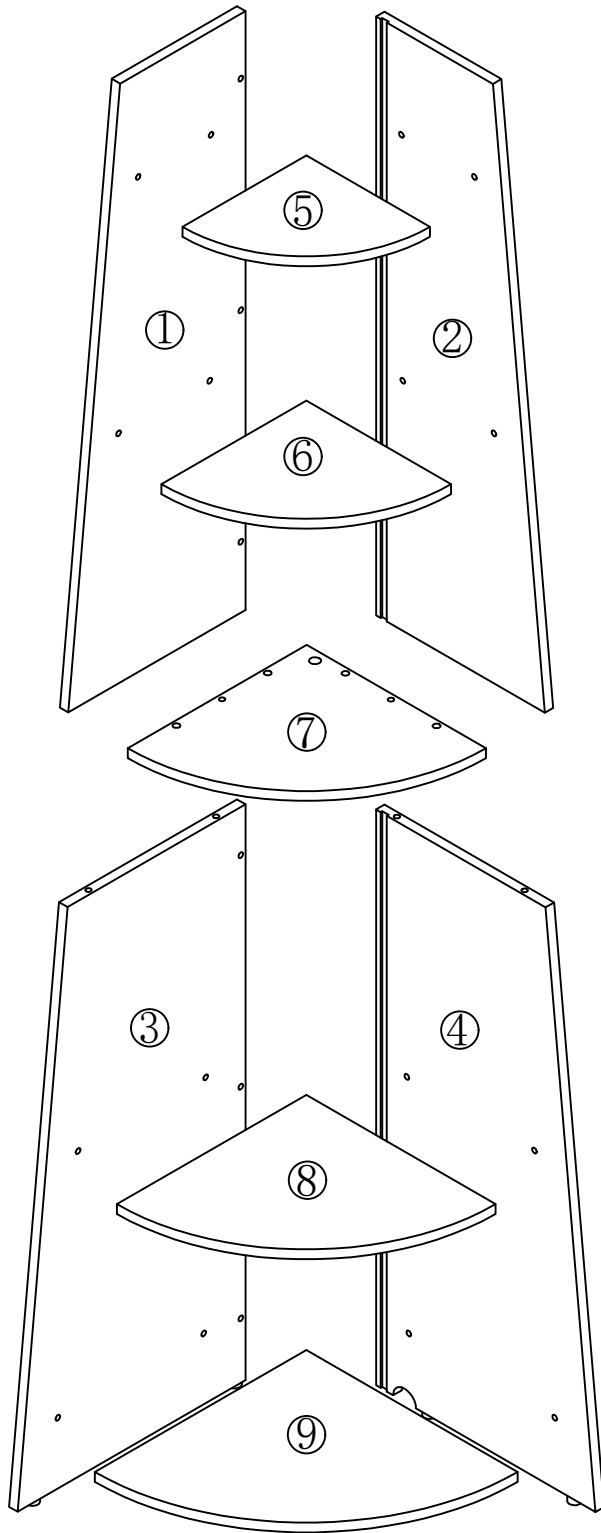



# STEP 1

3		1PCS
4		1PCS
A		3PCS

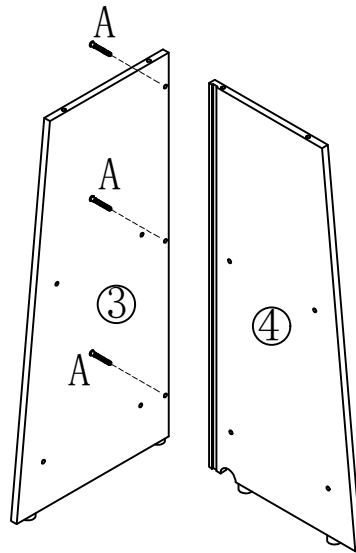

# STEP 2

1		1PCS
2		1PCS
A		3PCS

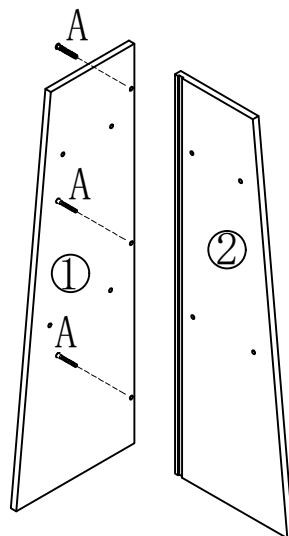



# STEP 3

7		1PCS
B		8PCS
D		2PCS

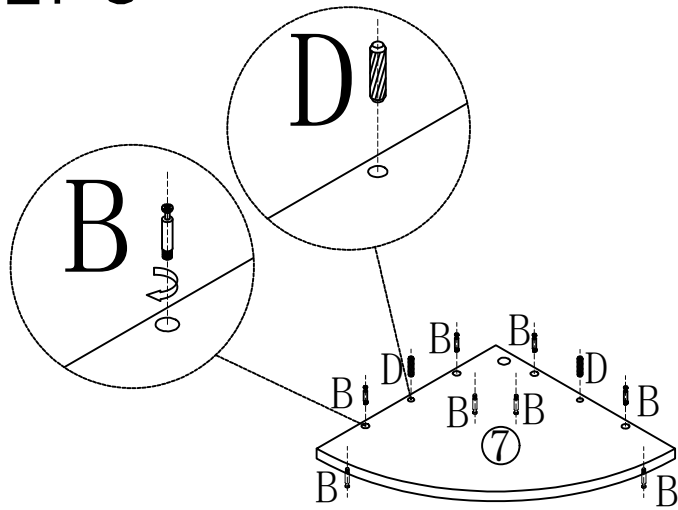

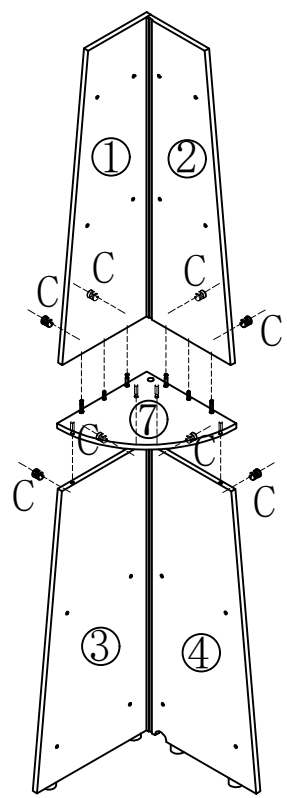

# STEP 4

7		1PCS
C		8PCS



# STEP 5

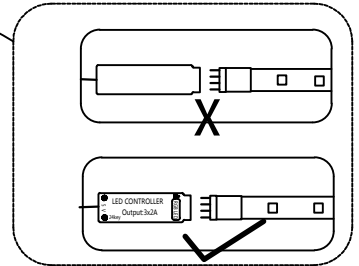
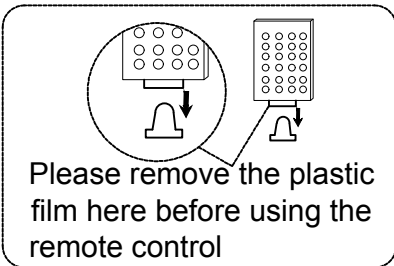
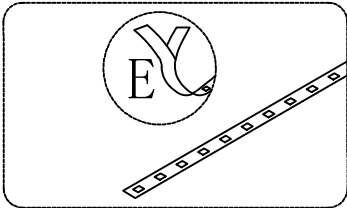
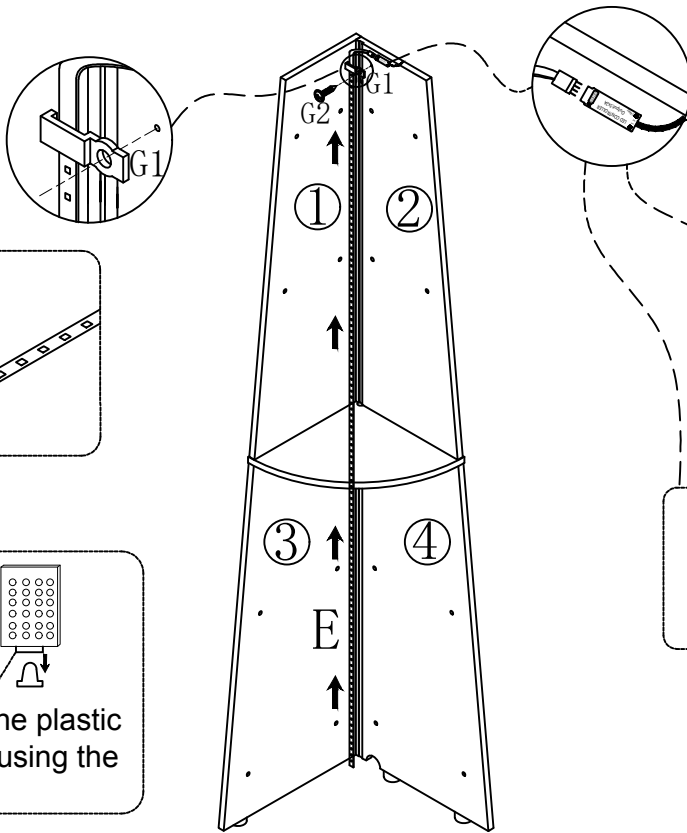

- E  1PCS
- G1  1PCS
- G2  1PCS



The infrared receiver must be placed in front to receive the signal

PLEASE NOTE! When installing the light strip please install the IR receiver above #2 and not below #4, thank you.

# STEP 6

- 9  1PCS
- B  2PCS
- D  1PCS

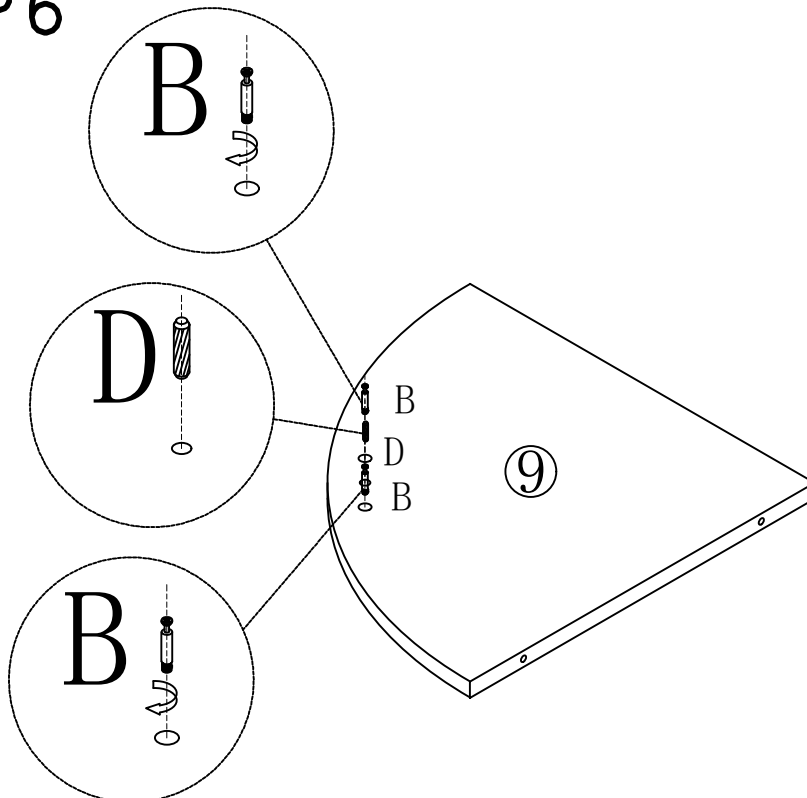



# STEP 7

9		1PCS
10		1PCS
C		2PCS

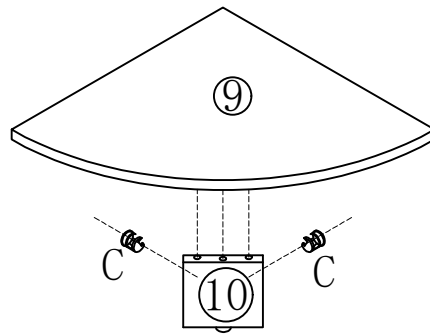

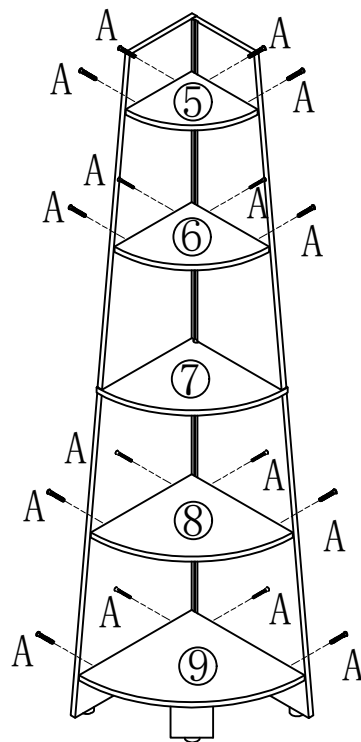

# STEP 8

5		1PCS
6		1PCS
8		1PCS
9		1PCS
A		16PCS

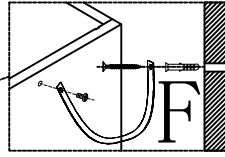
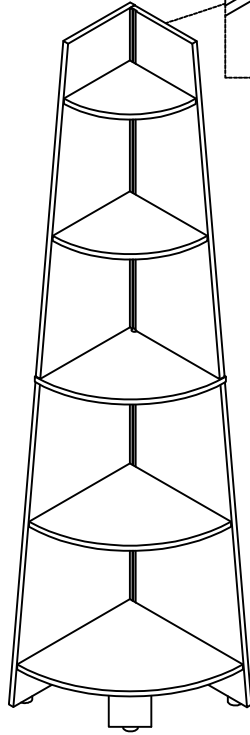

# STEP 9



- F
-  6X12mm
-  1PCS



Attention: For safety and stability, we suggest you have to secure the anti-tip accessories to the wall to prevent tipping, injury, and property damage.

