

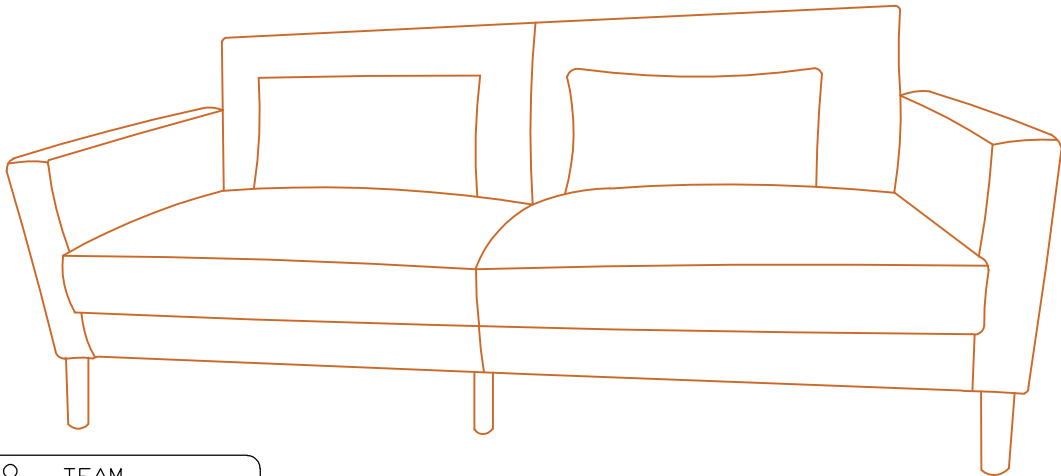

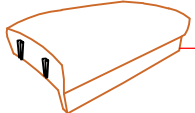

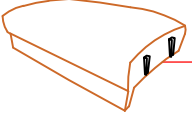

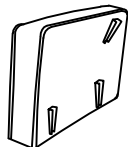

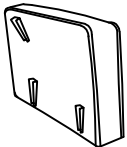
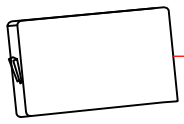
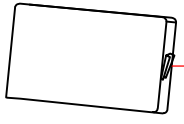



ASSEMBLY INSTRUCTION



SOFA BED

PARTS LIST

- | | | | |
|--|--|---|---|
|  A X 1pc |  B X 1pc |  C X 1pc |  D X 1pc |
| Left cushion | Right cushion | Left arm | Right arm |
|  E X 1pc |  F X 1pc |  G X 8pcs (8*22MM) |  H X 4pcs (6*20MM) |
| Left backrest | Right backrest | Washers | Short screw |
|  I X 2pc |  J X 1pc (4MM) |  K X 4pcs (8*30MM) |  L X 1pc |
| Throw pillows | L-Shaped Wrench | Long screw | Connecting rod |
|  M X 2pcs |  N X 1pcs (230MM) |  O X 4pcs |  P X 1pc (5MM) |
| Insert piece | Middle Leg | Legs | L-Shaped Wrench |
|  Q X 1pcs (250MM) | | | |
| Middle Leg | | | |

STEP 1

Parts and legs and hardware accessories can be found in the box.

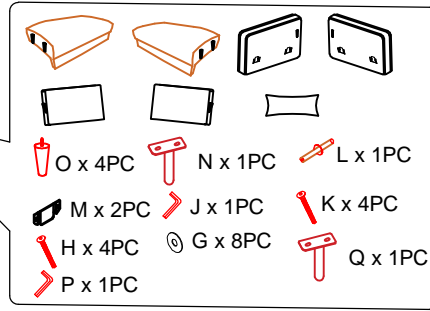
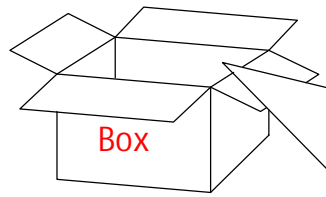

STEP 2

DO not over-tighten the screws DURING assembly.

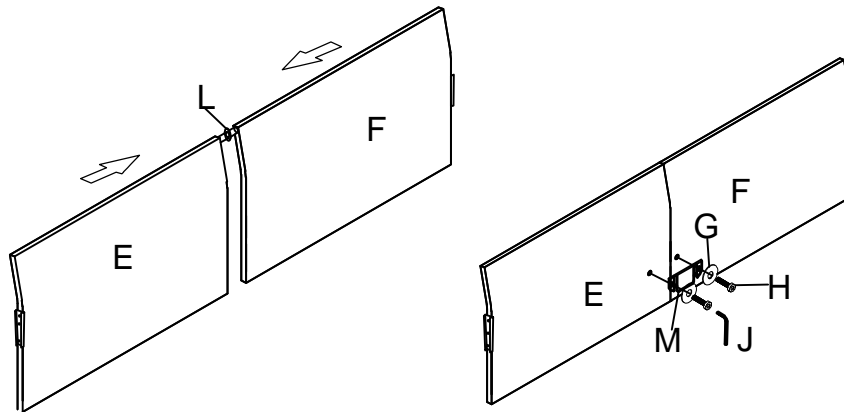

STEP 3

DO not over-tighten the screws DURING assembly.

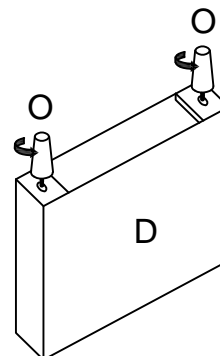
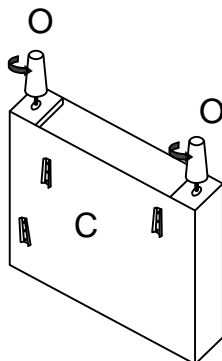
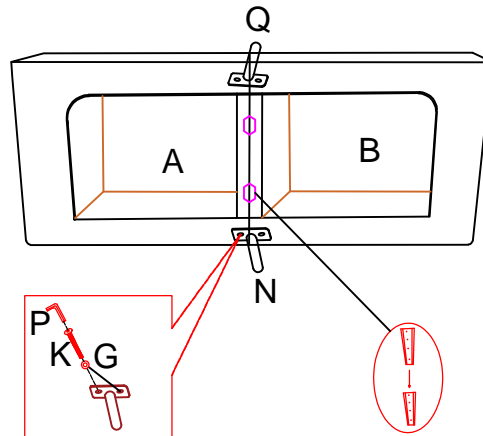
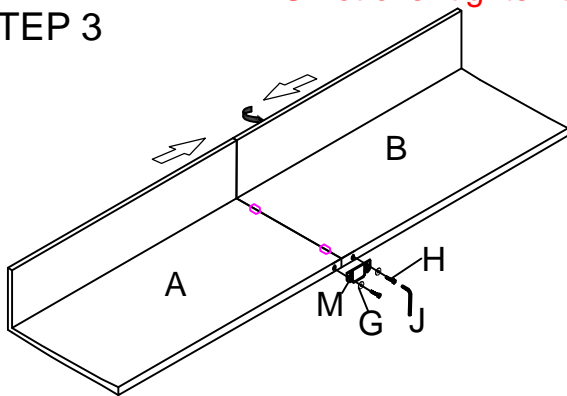

STEP 4

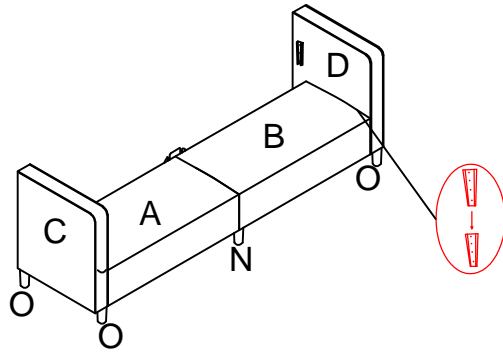

STEP 5

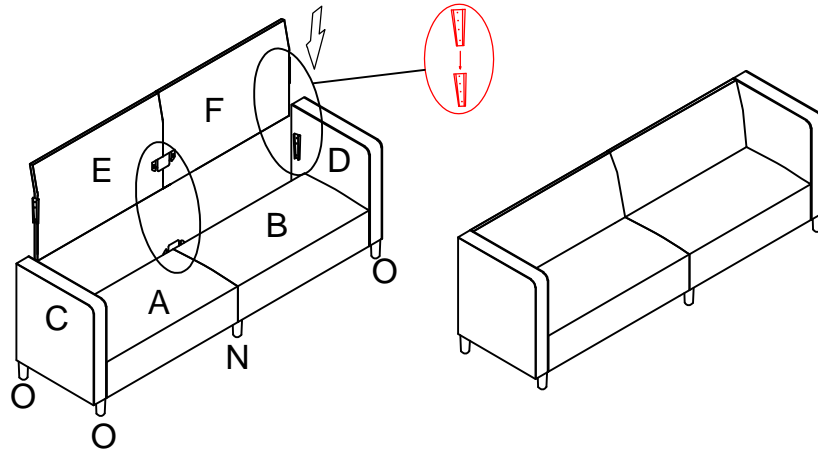

STEP 6

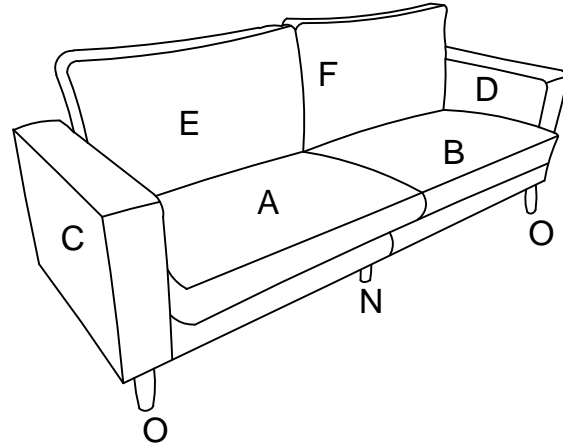

STEP 7

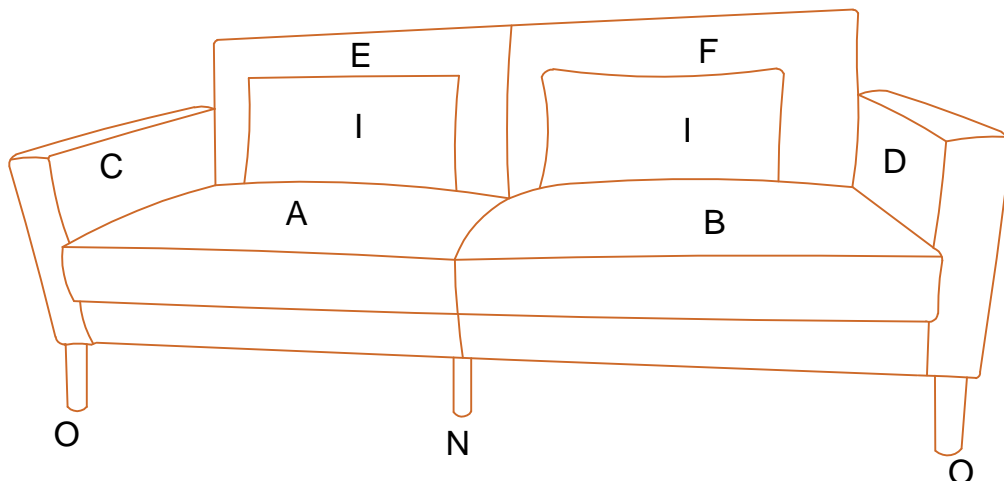

STEP 8

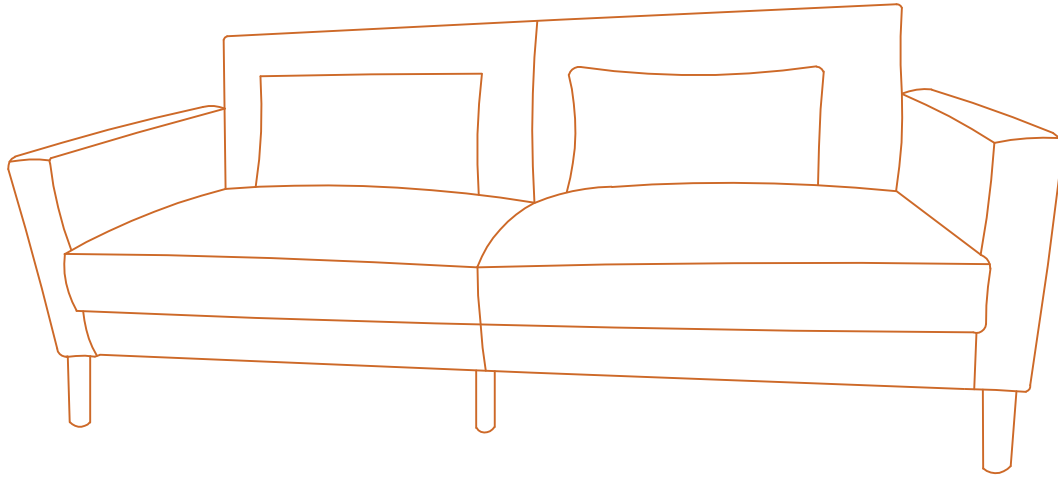

Notice:

Thank you for purchasing this quality product. Be sure to check all the packing material carefully for small parts, which may have come loose inside the carton during shipment. Identify and count all parts and compare with Part List on Page 1. This sofa is covered by 1-year Limited Warranty for Manufacturing Defects. Please read this Warranty Information carefully for your benefit. This warranty is for manufacturing defects.

Warranty Information

This warranty is for manufacturing defects only and does NOT cover normal wear & tear or damages resulting from misuse.

Warranty Details.

1. Your sofa's 1-year Limited Warranty for Manufacturing Defects starts on the date of purchase. No warranty will be honored without an original sales receipt. The warranty and financial responsibility of the manufacturer applies only to the products themselves.
2. Manufacturing defects may include circumstances where the product is broken under normal use and hence cannot provide proper support. In the event of a manufacturing defect found in your sofa, please stop using it immediately and contact the authorized seller .
3. This warranty applies only if the product has been used properly by consumers who purchase it from authorized sellers as a new product. Proper use is defined by but not limited to level surface where all legs touch the floor with an equal distribution of weight and no out-of-the-ordinary abuse by the consumer. This warranty does not constitute agreement to replace other parts.
4. If this sofa fails to perform as advertised due to manufacturing defects, the manufacturer will repair or replace at its discretion reserves the right to substitute comparable materials or models and does not guarantee that the replacement part will match existing pieces.
5. In the event the product needs to be inspected by the manufacturer to determine a warranty claim, transportation and removal cost will be borne by the consumer.