

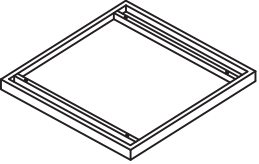

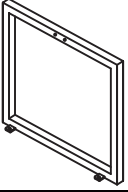
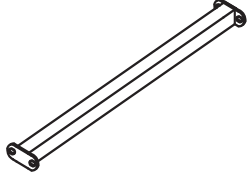

ASSEMBLY INSTRUCTION

* Don't fully tighten all the bolts till the very end!

PRE-ASSEMBLY PREPARATION:

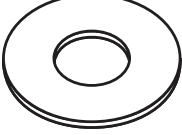
- Please read through the instructions before beginning assembly.
- Clear out the space for assembly and lay out all of the parts based on the Parts List, extra room will allow you to easily determine if all the pieces are present.
- Keep small parts and pieces away from children until fully assembled.

Part No.	Image	Qty	Part No.	Image	Qty	Part No.	Image	Qty
A		1	B		2	C		1
D	 M6 * 20 MM	8	E		8	F		1

STEP 1

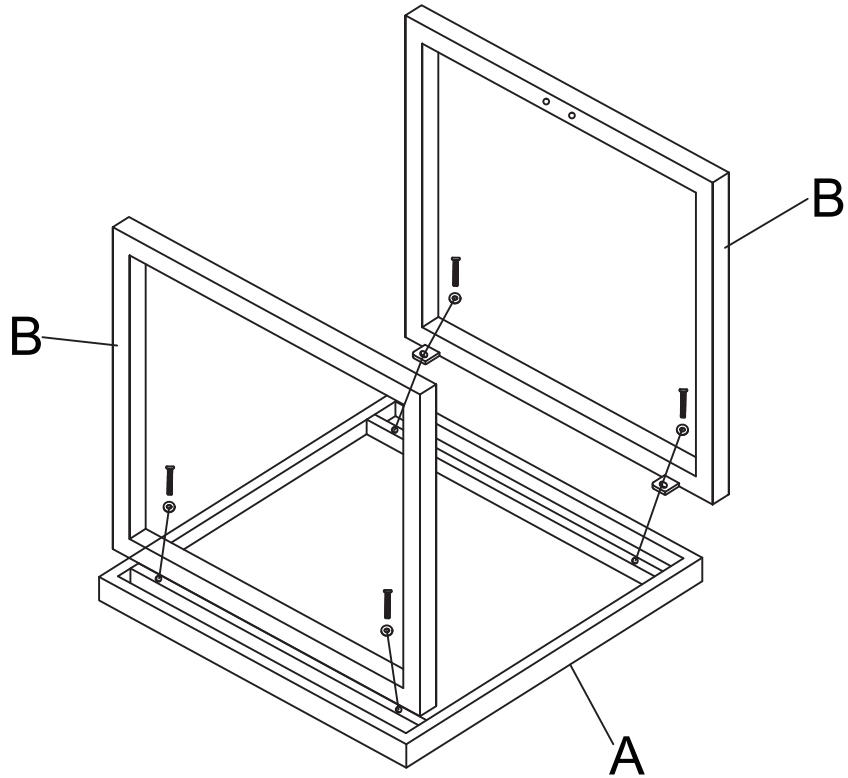

STEP 2

