

ASSEMBLY INSTRUCTIONS

Thanks for choosing our product. Please kindly check parts listed below and read this manual carefully, then assemble them step by step. Please feel free to contact us for any questions.

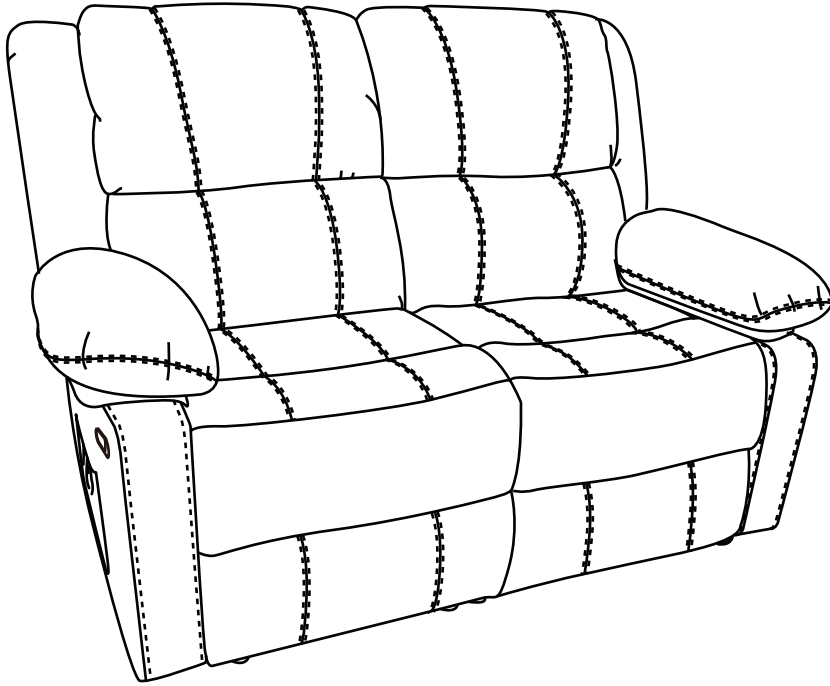
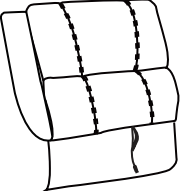
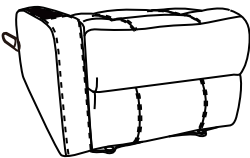
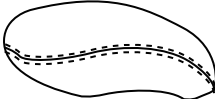
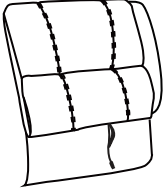
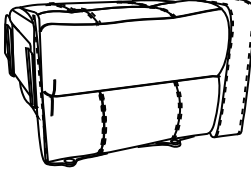
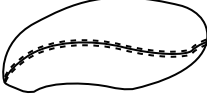
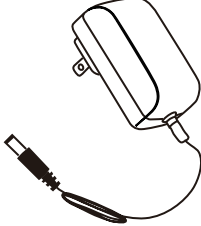
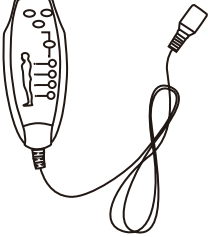

| Parts List | | | |
|--|--|--|---|
| A X1  Left Backrest | B X1  Left Seat | C X1  Left Armrest | D X1  Right Backrest |
| E X1  Right Seat | F X1  Right Armrest | G X2  Plug | H X2  Remote |

STEP 1

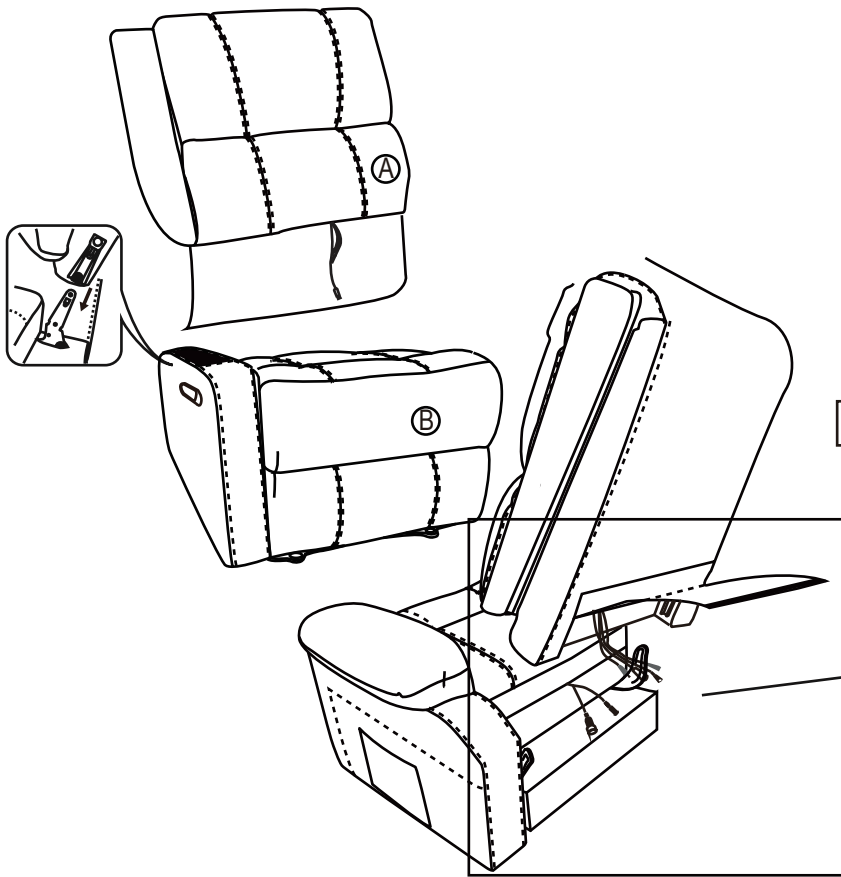

No.1 and No.2 wire connect with the backrest and chair base.

No.3 wire connects with backrest and power cord(D).

No.4 wire connects with backrest and remote control(E).

NOTE: Two same color wires connect.

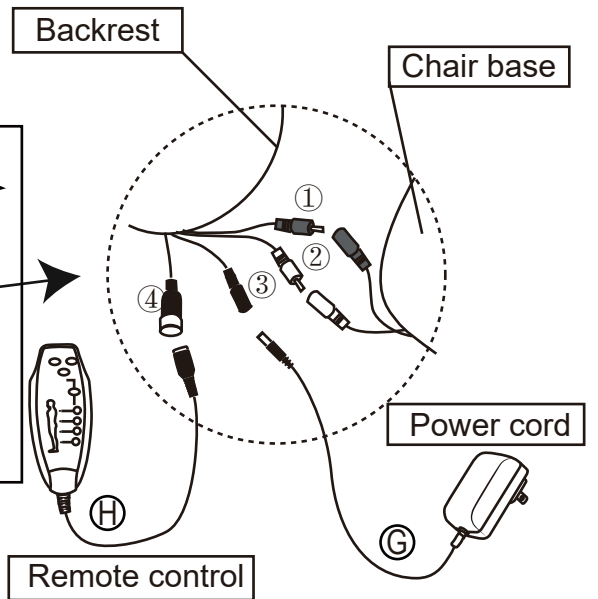

STEP 2

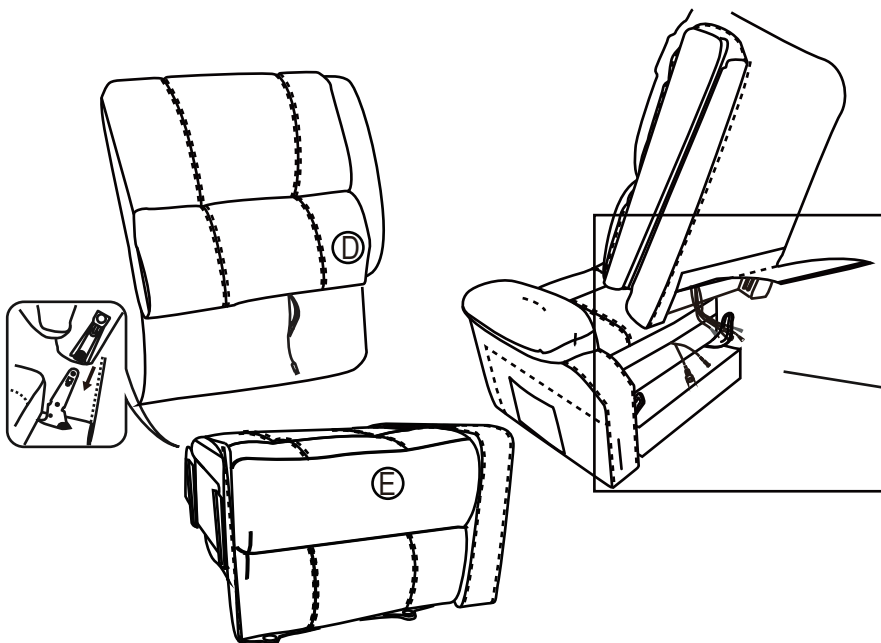

No.1 and No.2 wire connect with the backrest and chair base.

No.3 wire connects with backrest and power cord(D).

No.4 wire connects with backrest and remote control(E).

NOTE: Two same color wires connect.

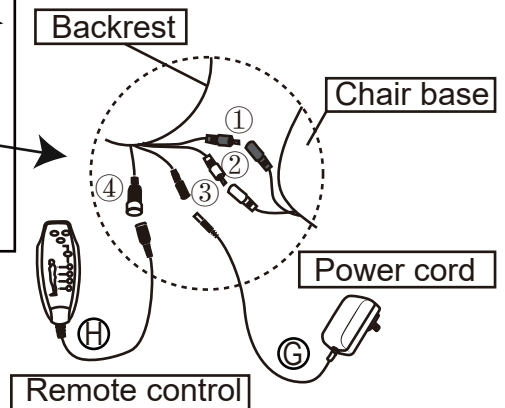

STEP 3

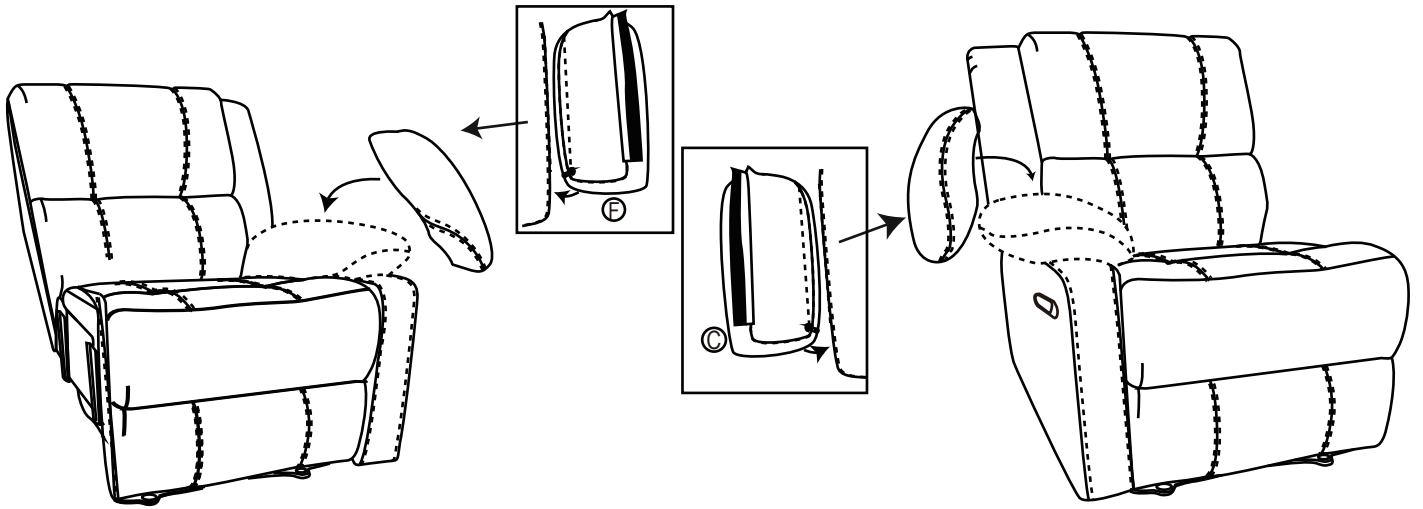

STEP 4

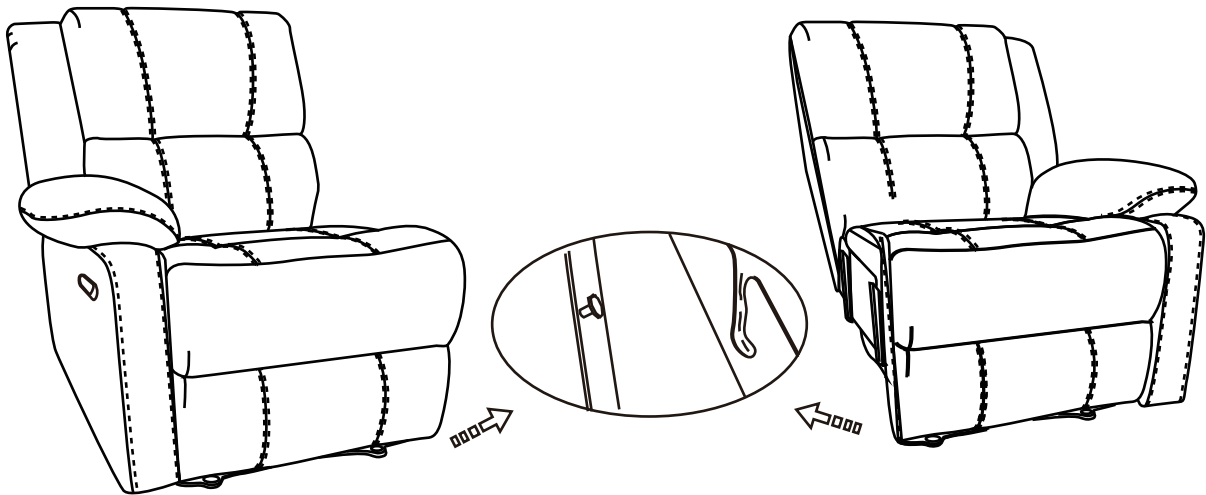

STEP 5

