

# ASSEMBLY INSTRUCTIONS



*Fine Furniture for every stage of life*

## 2PC SECTIONAL

# ASSEMBLY INSTRUCTIONS

## ASSEMBLY TIPS:

1. Remove hardware from box and sort by size.
2. Please check to see that all hardware and parts are present prior to start of assembly.
3. Please follow attached instructions in the same sequence as numbered to assure fast & easy assembly.



### WARNING!

1. Don't attempt to repair or modify parts that are broken or defective. Please contact the store immediately.
2. This product is for home use only and not intended for commercial establishments.

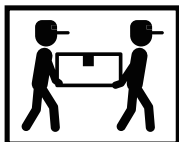

ASSEMBLY TIME

5 MINUTES

## PARTS IDENTIFICATION

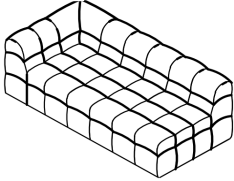
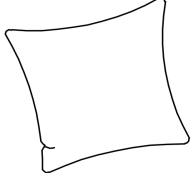
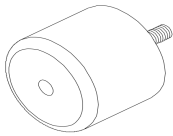
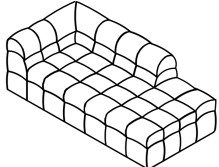
B1	PART NAME	FIGURE	QUANTITY
A	LAF LOVESEAT		1PC
B	PILLOW		8PCS
C	LEG		8PCS
D	RAF CHAISE		1PC

**ASSEMBLY INSTRUCTIONS**  
**STEP 1**

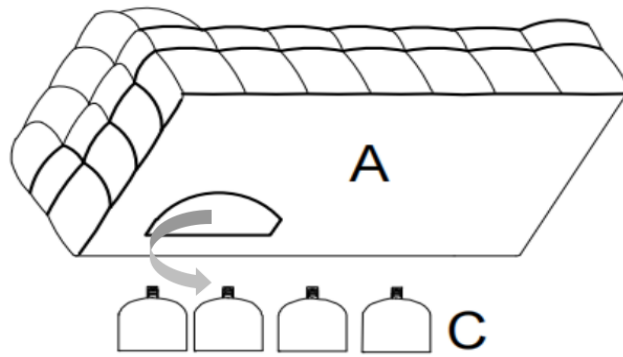

**STEP 2**

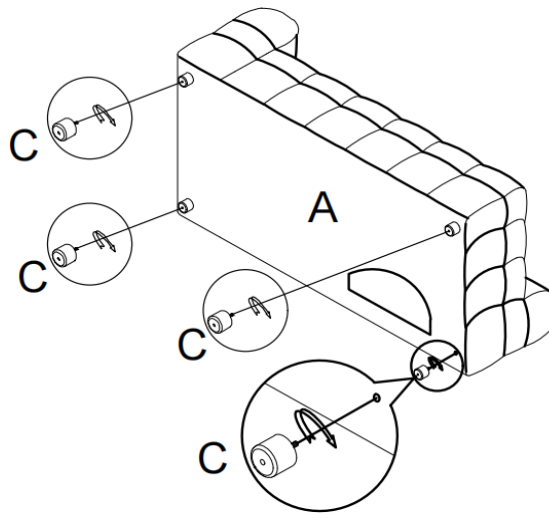

**STEP 3**

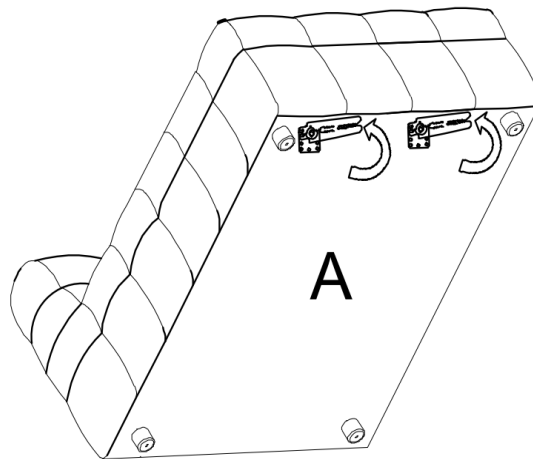

**STEP 4**

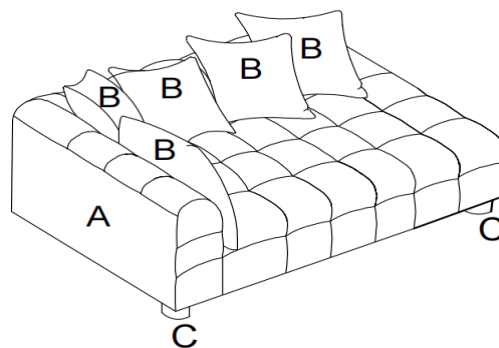

**ASSEMBLY INSTRUCTIONS**  
**STEP 5**

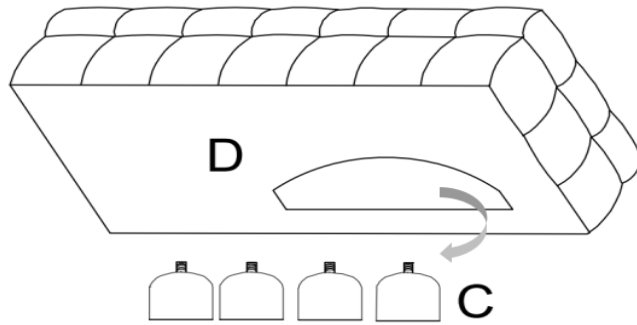

**STEP 6**

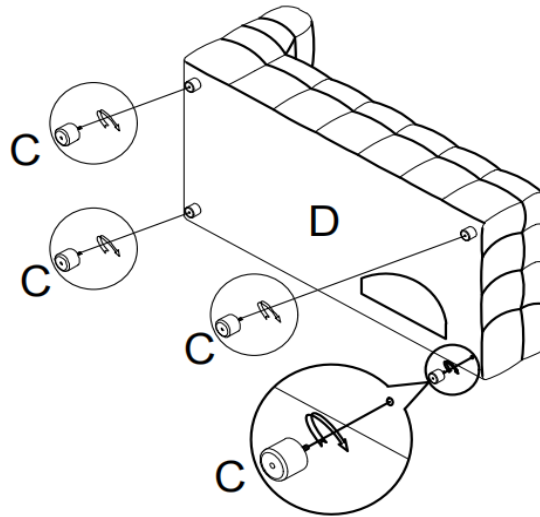

**STEP 7**

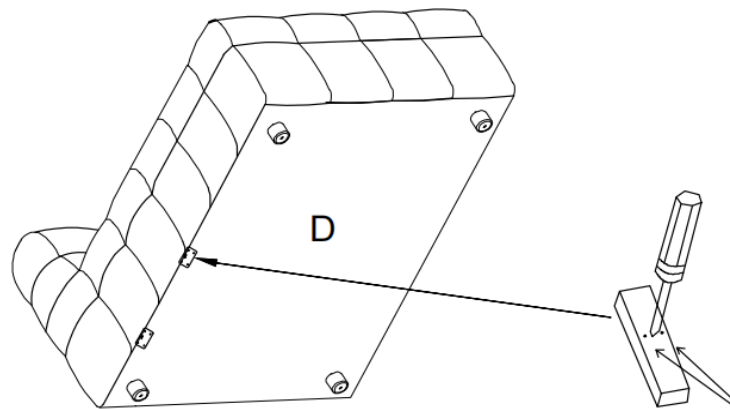

**STEP 8**

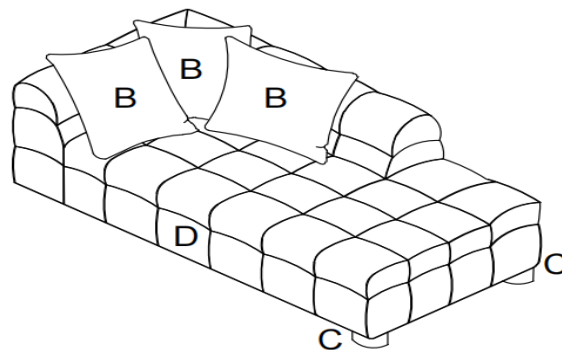

# ASSEMBLY INSTRUCTIONS

## STEP 9

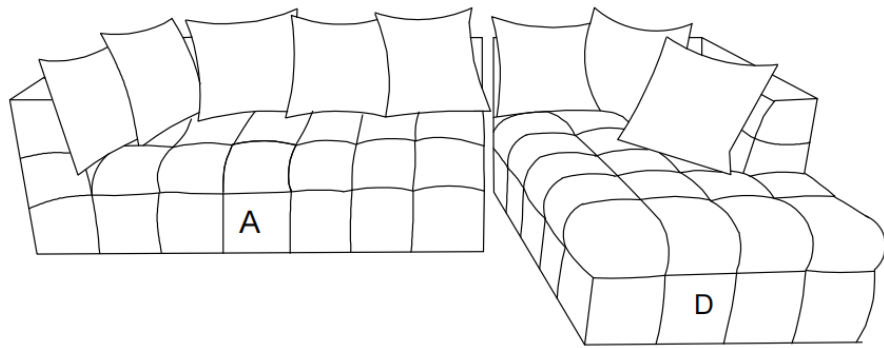

## STEP 10

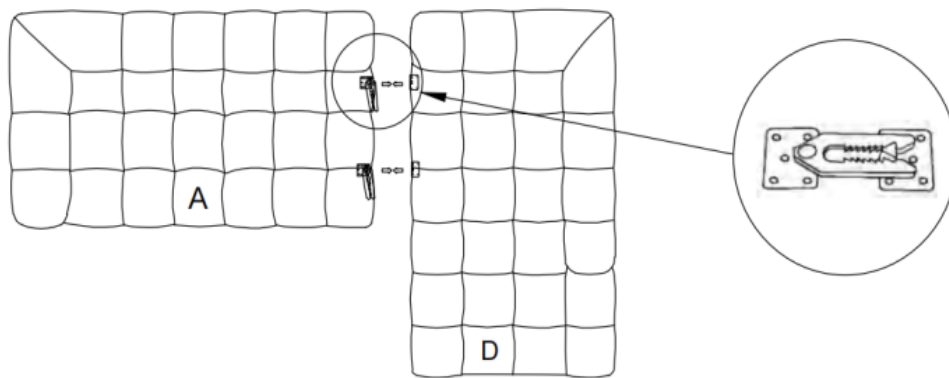

## STEP 11

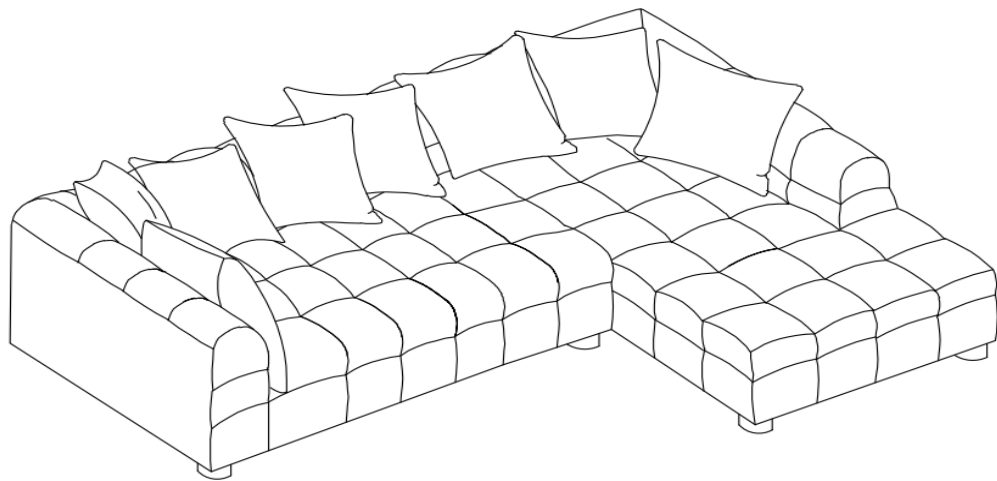

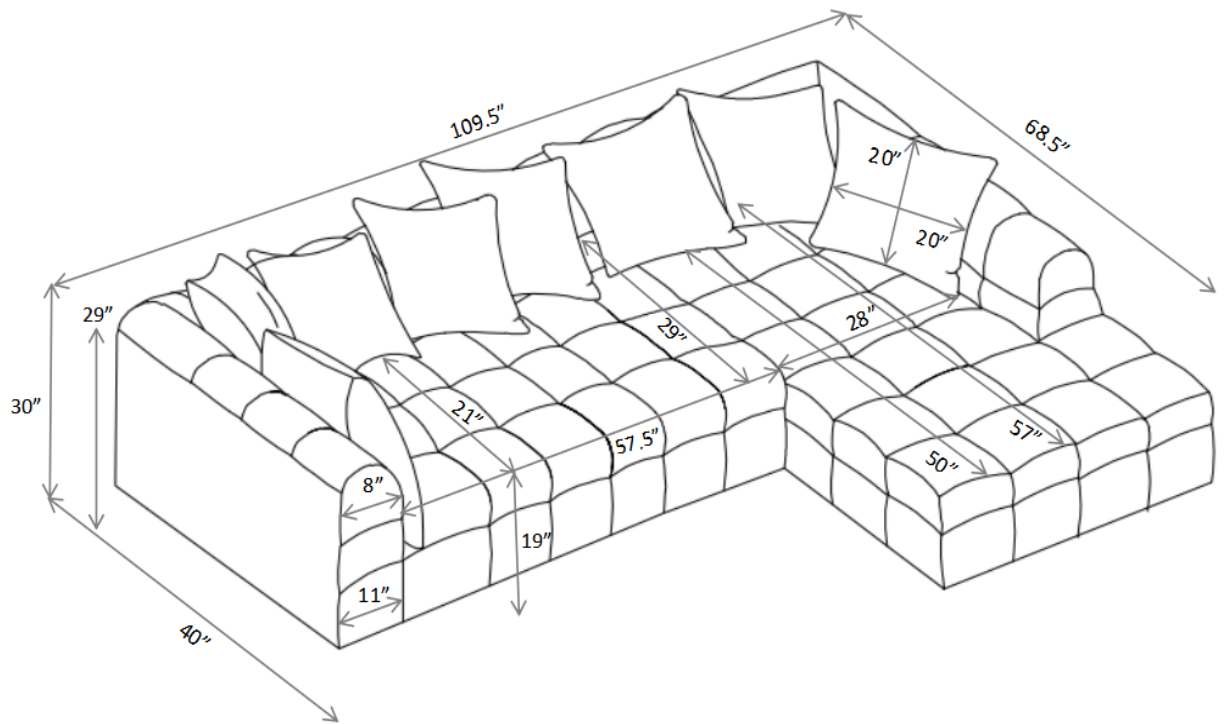

Note : Dimension tolerance  $\pm 5\%$

