

## CARE AND MAINTENANCE





Wipe clean with a soft, dry cloth. Test the cleaning method on a hidden area before using them over the entire area.

## NOTICE

- \* Please make sure that you have all parts indicated before you begin assembly of this item.
- \* This item should be assembled on a soft surface to prevent scratching the finished product during assembly.
- \* This item may require periodic tightening.
- \* Do not tighten bolts until completely assembled.

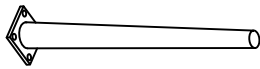
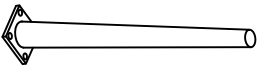
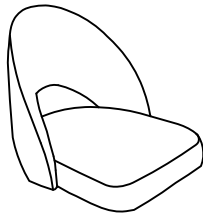
Product Dimensions: 21-1/4"W x 24-1/4"D x 31-3/4"H

## Part List and Hardware List

PIECE	DESCRIPTION	PICTURE	QUANTITY
A	FRONT LEG		2x
B	BACK LEG		2x
C	CUSHION		1x
H1	Allen Bolt	 1/4"x 5/8"	16x
H2	Flat Washer	 $\phi 16 \times 1.0$	16x
H3	Spring Washer	 1/4"	16x
H4	Allen Key	 M4	1x

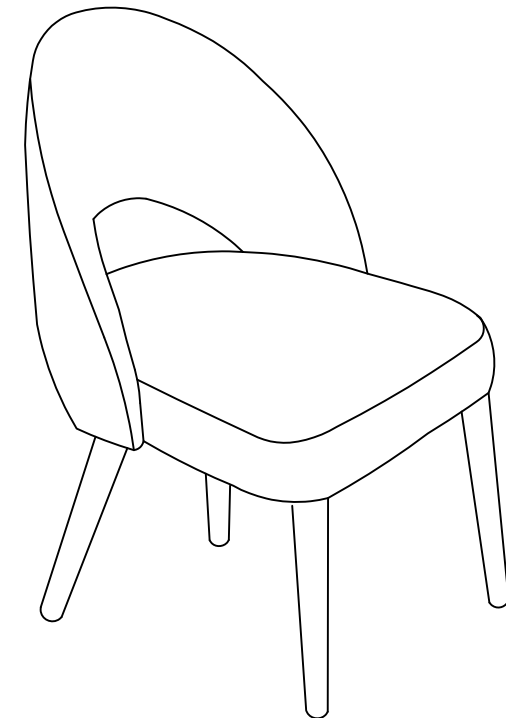

Weight capacity : 275 lbs  
WARNING : DO NOT STAND ON THE CHAIR

## PREPARATION

Before beginning assembly of product, make sure all parts are present. Compare parts with package contents list and hardware contents list. If any part is missing or damaged, do not attempt to assemble the product.

Estimated Assembly Time: 15 minutes.

Tools Required for Assembly (included): Allen Key

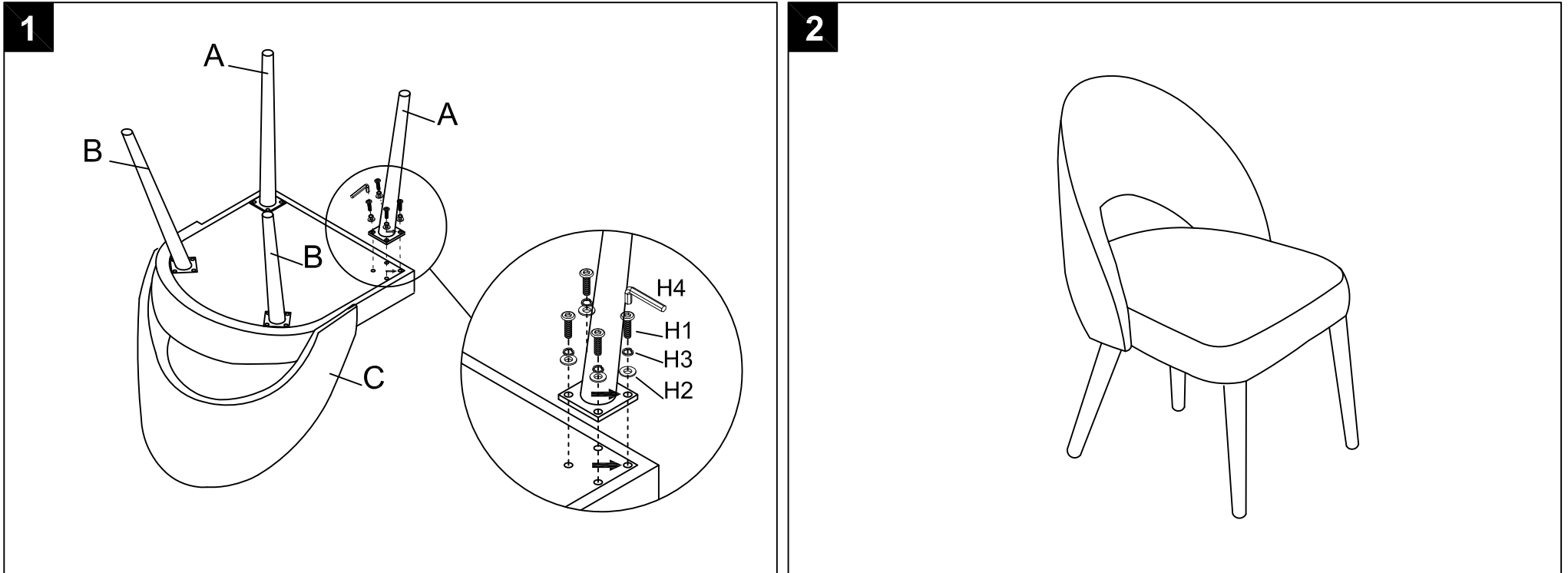

### Step 1

Attach 2\*front legs (A) and 2\*back legs (B) to the underneath of seat cushion (C) by using Allen key (H4) to lock Allen bolts (H1) with Spring Washers (H3) and Flat Washers (H2), as picture.

\*NOTICE : The screw hole of front leg and screw hole of seat bottom with indicated by the arrow need to be aligned.

### Step 2

Assembly is completed.