

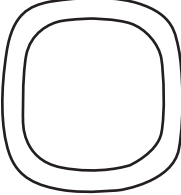
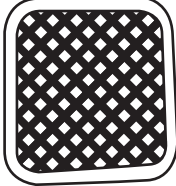
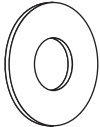
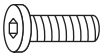

	PART LIST	DESCRIPTON	QTY
A		LEG	4
B		TABLE TOP	1
C		TRAY	1
D		WASHER -- M6	12
E		BOLT -- M6 x 12mm	12
F		HEX WRENCH	1

PRE-ASSEMBLY PREPARATION:

- Please read through the instructions before beginning assembly.
- Clear out the space for assembly and lay out all of the parts based on the Parts List, extra room will allow you to easily determine if all the pieces are present.
- Keep small parts and pieces away from children until fully assembled.

Step 1: Attach 4pcs legs (A) to table top (B) with 8pcs bolts (E) and 8pcs washers (D).

* Do not fully tighten bolts until the entire frame is assembled

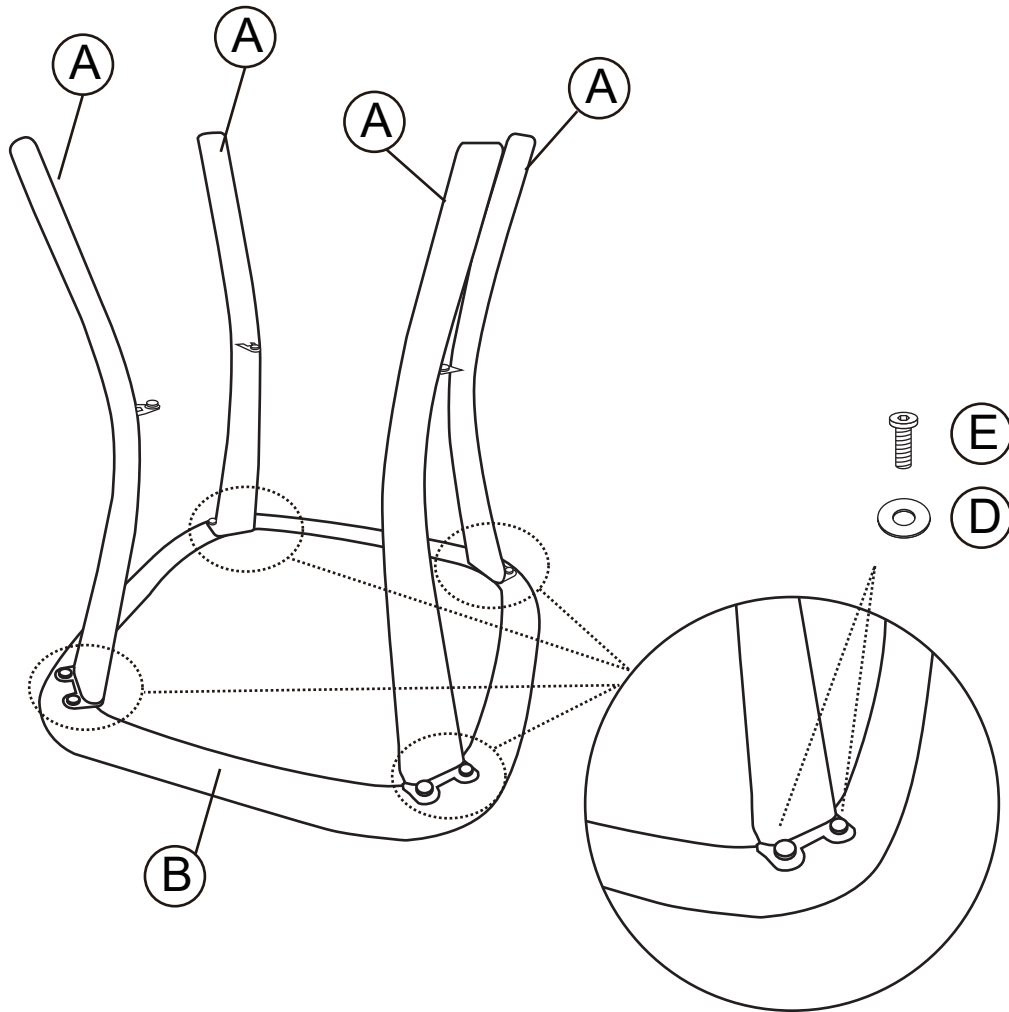

Step 2: Attached tray (C) to legs (A) with 4pcs bolts (E) and 4pcs washers (D).

Turn over the assembled table. Verify the alignment and adjust, now fully tighten all the bolts using Hex Wrench (F)

