

**TABLE D'APPOINT - 47" L / CONSOLE D'ENTREE
CAPPUCCINO**

**ACCENT TABLE - 47" L / CAPPUCCINO HALL
CONSOLE**

**INSTRUCTIONS D'ASSEMBLAGE
ASSEMBLY INSTRUCTIONS**





**POUR DE L'ASSISTANCE OU POUR COMMANDER
DES PIÈCES CONTACTEZ NOTRE DÉPARTEMENT
DE SERVICE À LA CLIENTÈLE.**

**FOR ASSISTANCE OR TO ORDER PARTS
CONTACT OUR CUSTOMER SERVICE DEPARTMENT**

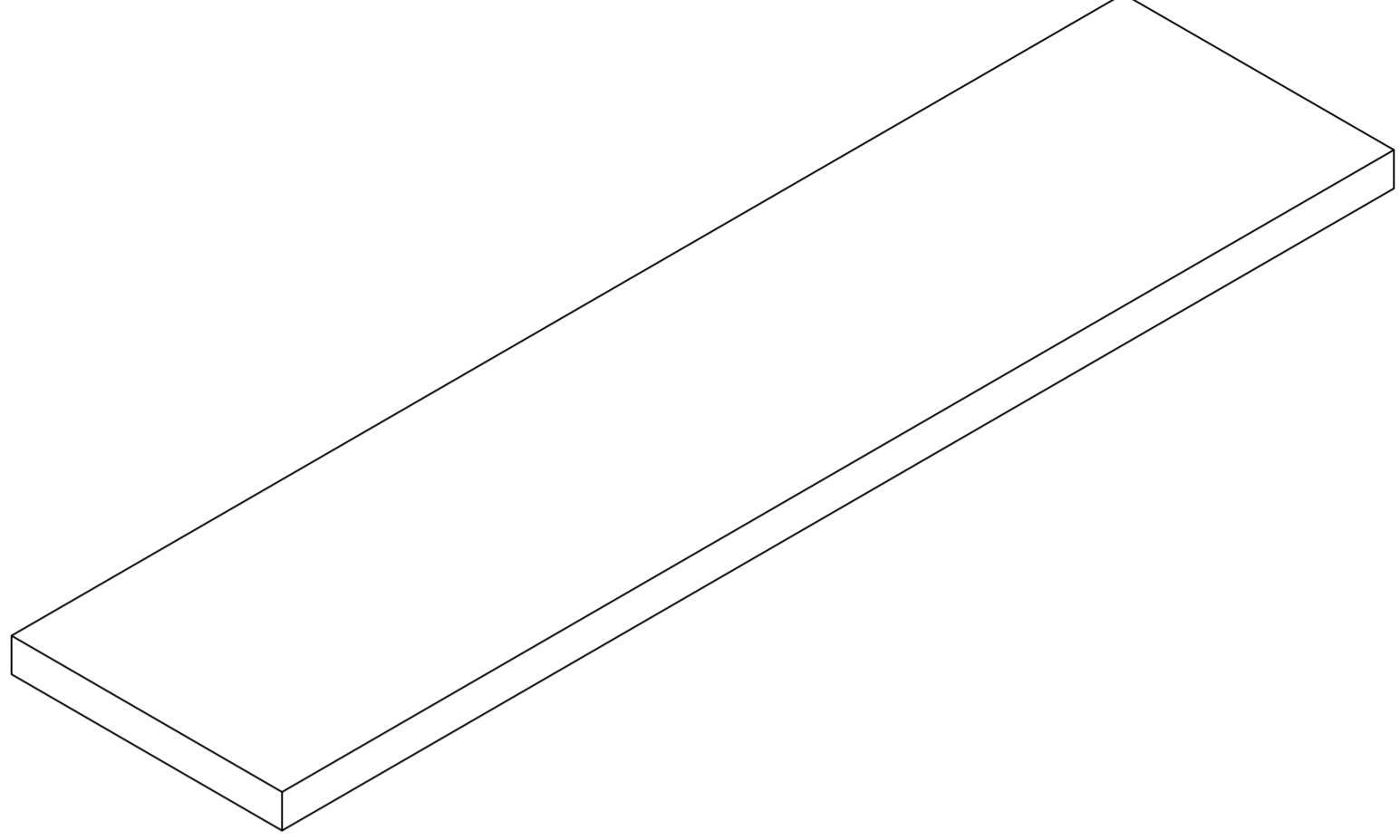
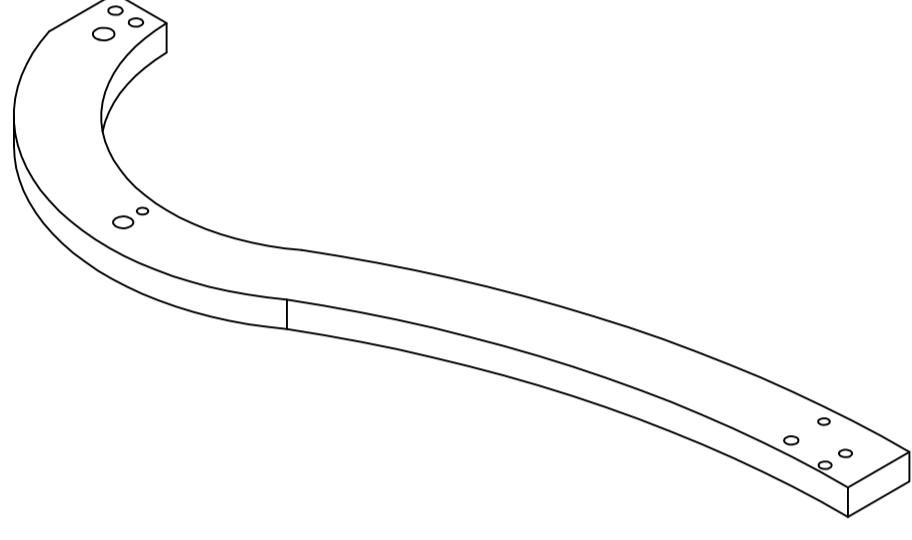
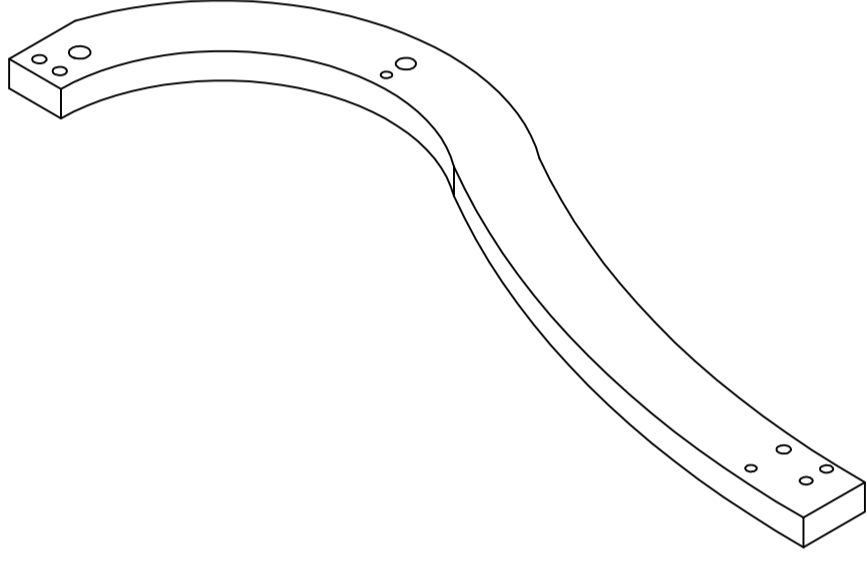
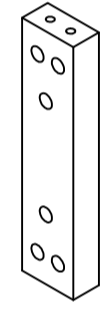
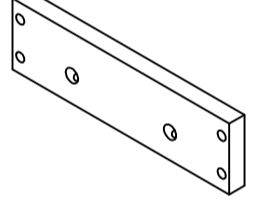
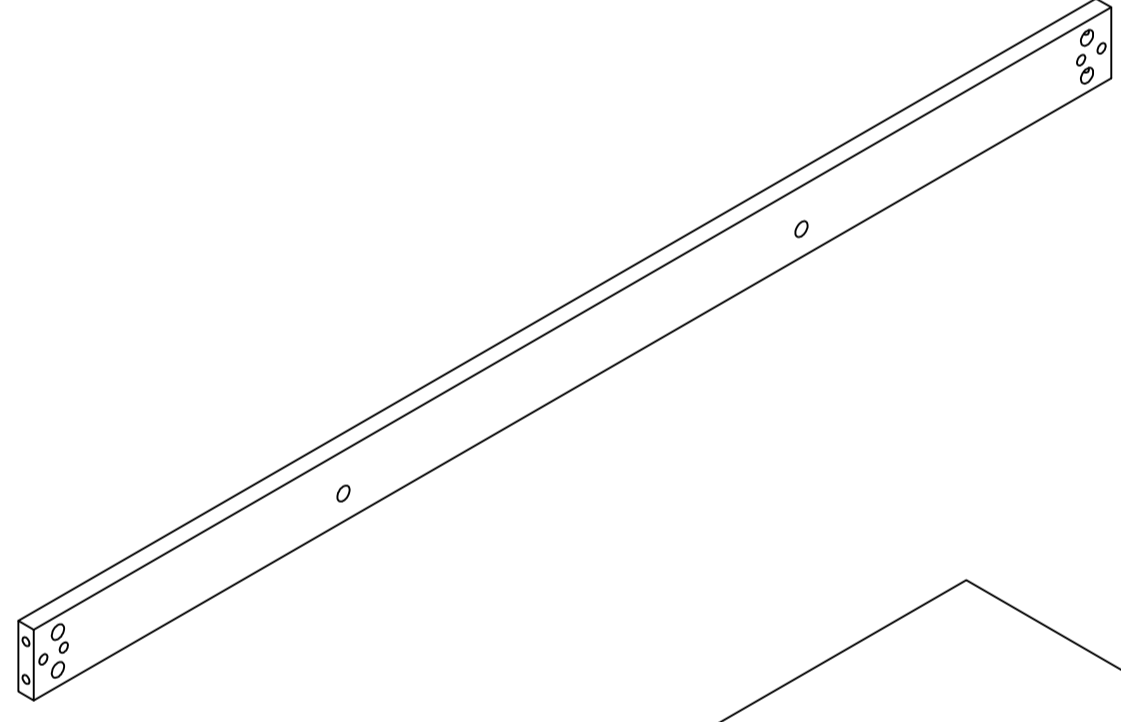
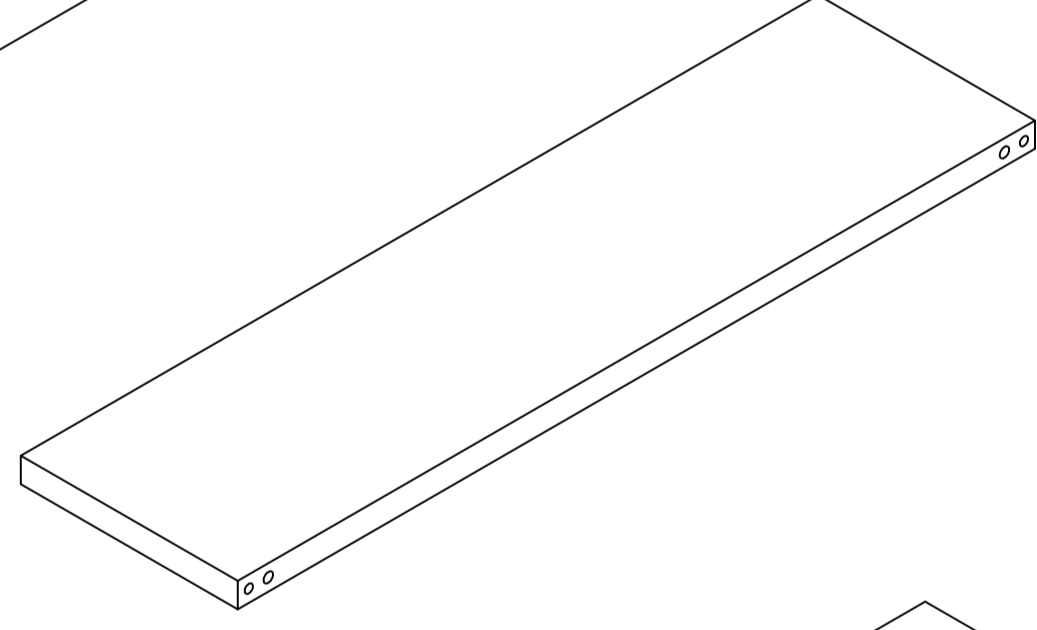
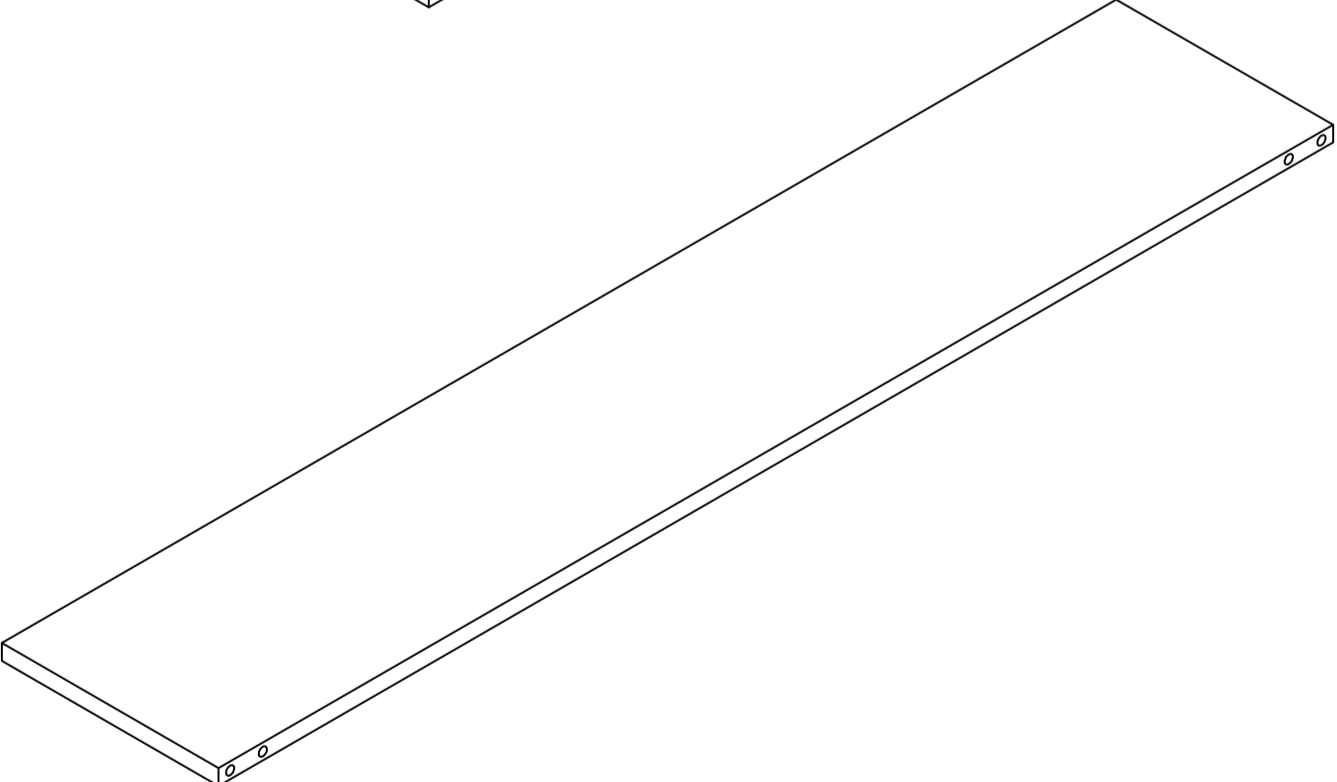
IDENTIFICATION DES PIÈCES
PARTS IDENTIFICATION

1		PANNEAU DU DESSUS TOP PANEL	1MC/PC
2		PATTE DROIT RIGHT LEG	1MC/PC
3		PATTE GAUCHE LEFT LEG	1MC/PC
4		BARRE DE SOUTIEN SUPPORT BAR	1MC/PC
5		BARRE DE SOUTIEN SUPPORT BAR	1MC/PC
6		BARRE DE SOUTIEN SUPPORT BAR	1MC/PC
7		PANNEAU DE TABLETTE SHELF PANEL	1MC/PC
8		PANNEAU DU BAS BOTTOM PANEL	1MC/PC

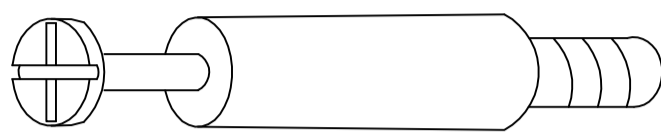
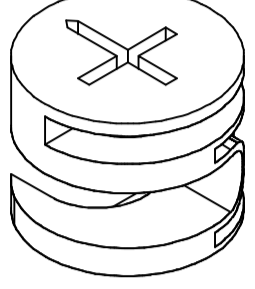
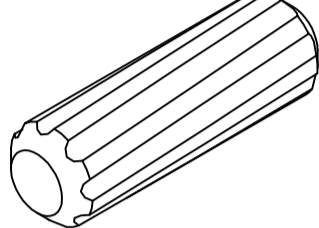
IDENTIFICATION DES PIÈCES DE MONTAGE
HARDWARE IDENTIFICATION

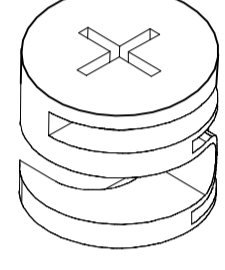
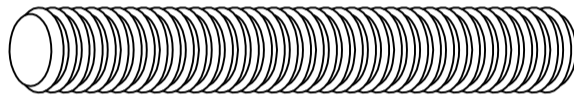
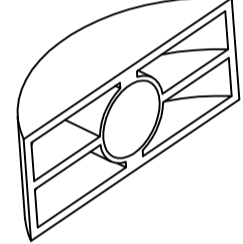
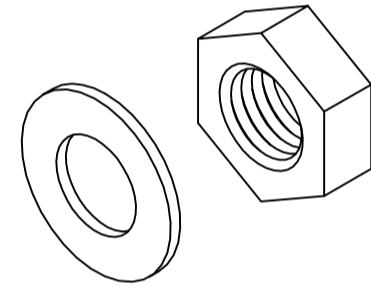
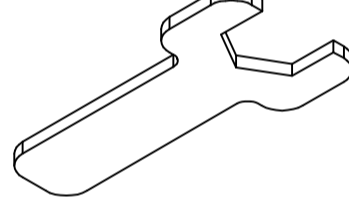
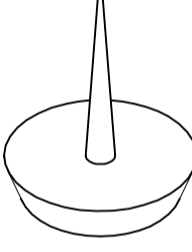
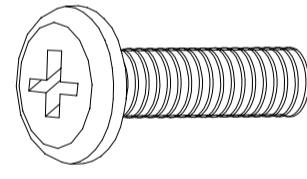
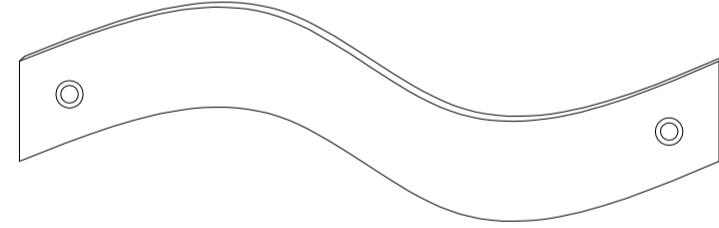
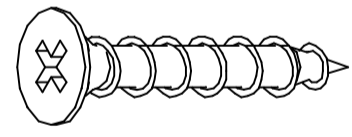
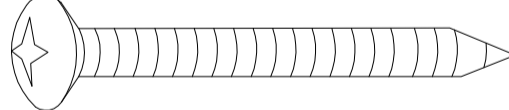
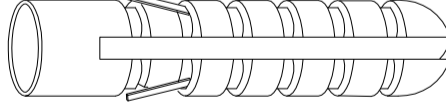
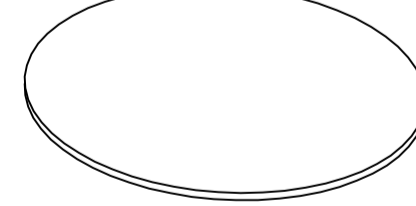
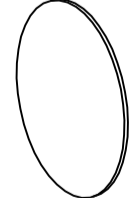
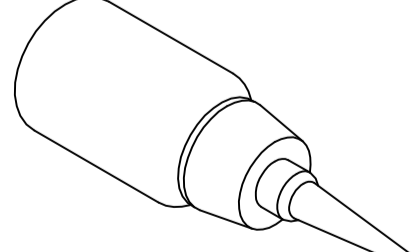
A		L29	20MCX/PCS
B		Ø15	20MCX/PCS
C		Ø8×25mm	14MCX/PCS
D		L23	16MCX/PCS
E		Ø12	16MCX/PCS
F		M8×70mm	4MCX/PCS
G			4MCX/PCS
H		M8	4MCX/PCS
I		M13	1MC/PC
J		Ø16mm	6MCX/PCS
K		M6×25mm	8MCX/PCS
L			1MC/PC
M		Ø4×25	1MC/PC
N		Ø5×40	1MC/PC
O		Ø8×40	1MC/PC
P		Ø45mm	4MCX/PCS
Q		Ø20mm	16MCX/PCS
R		COLLE/GLUE	1MC/PC

ÉTAPE / STEP 1

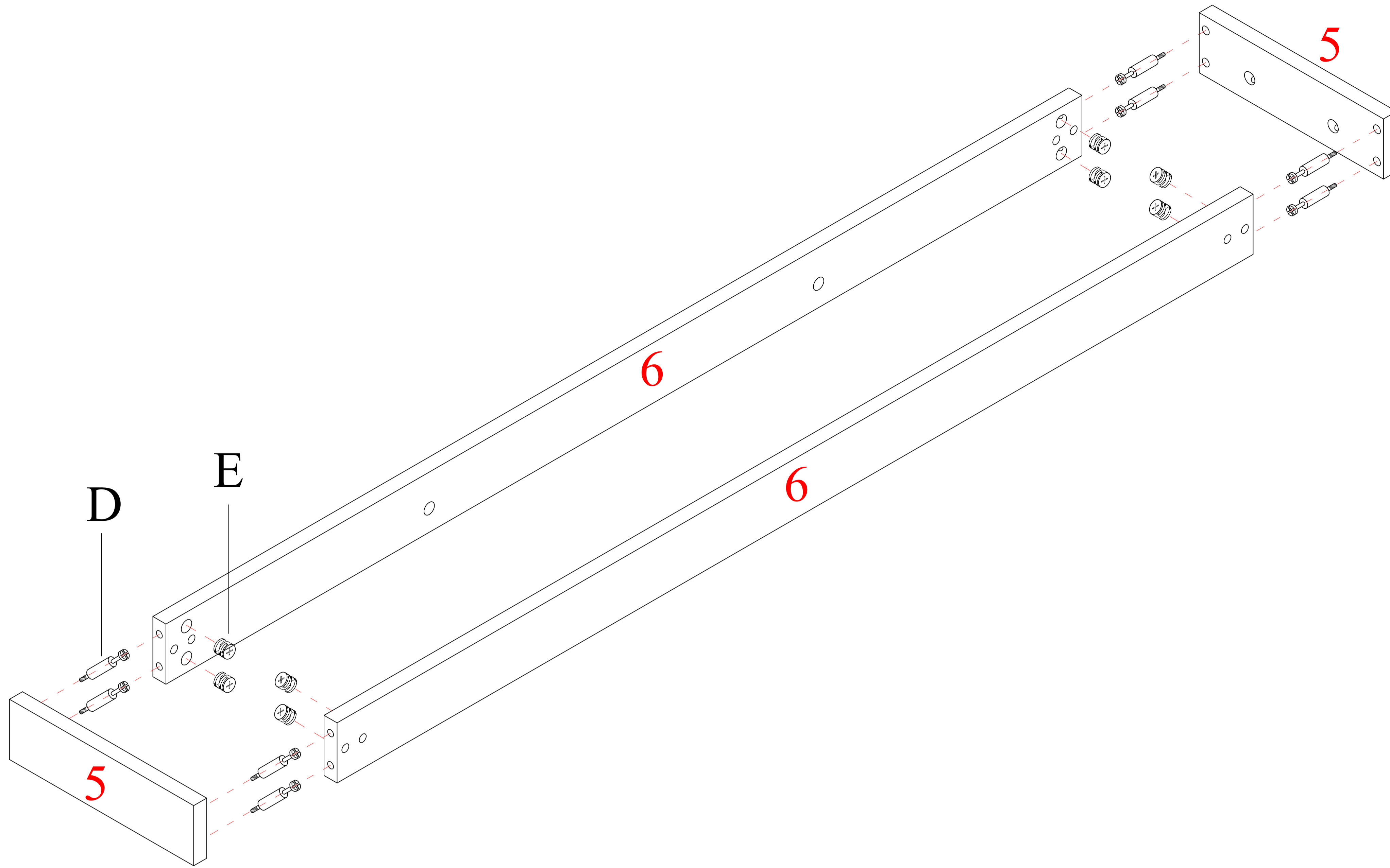

ÉTAPE / STEP 2

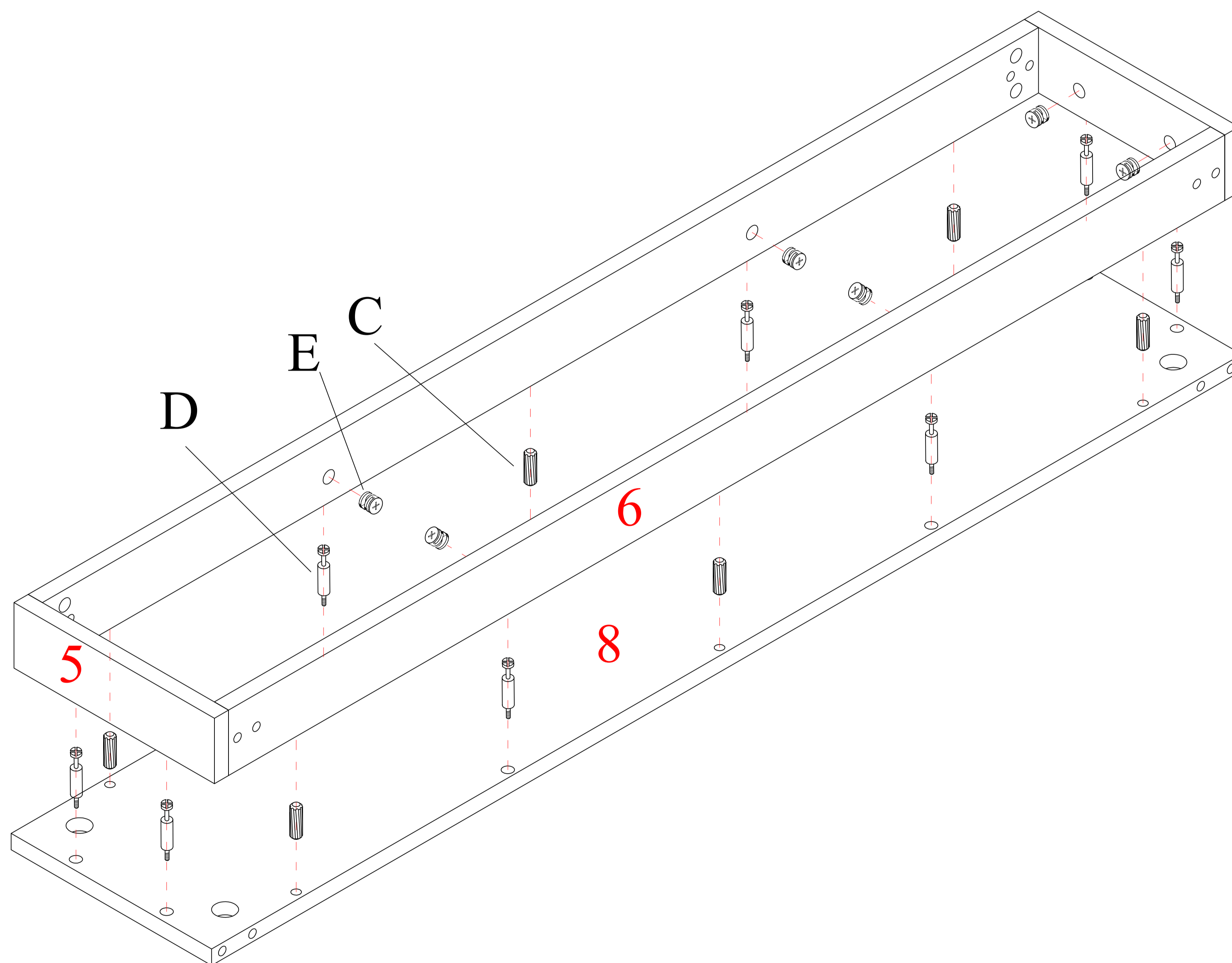

ÉTAPE / STEP 3

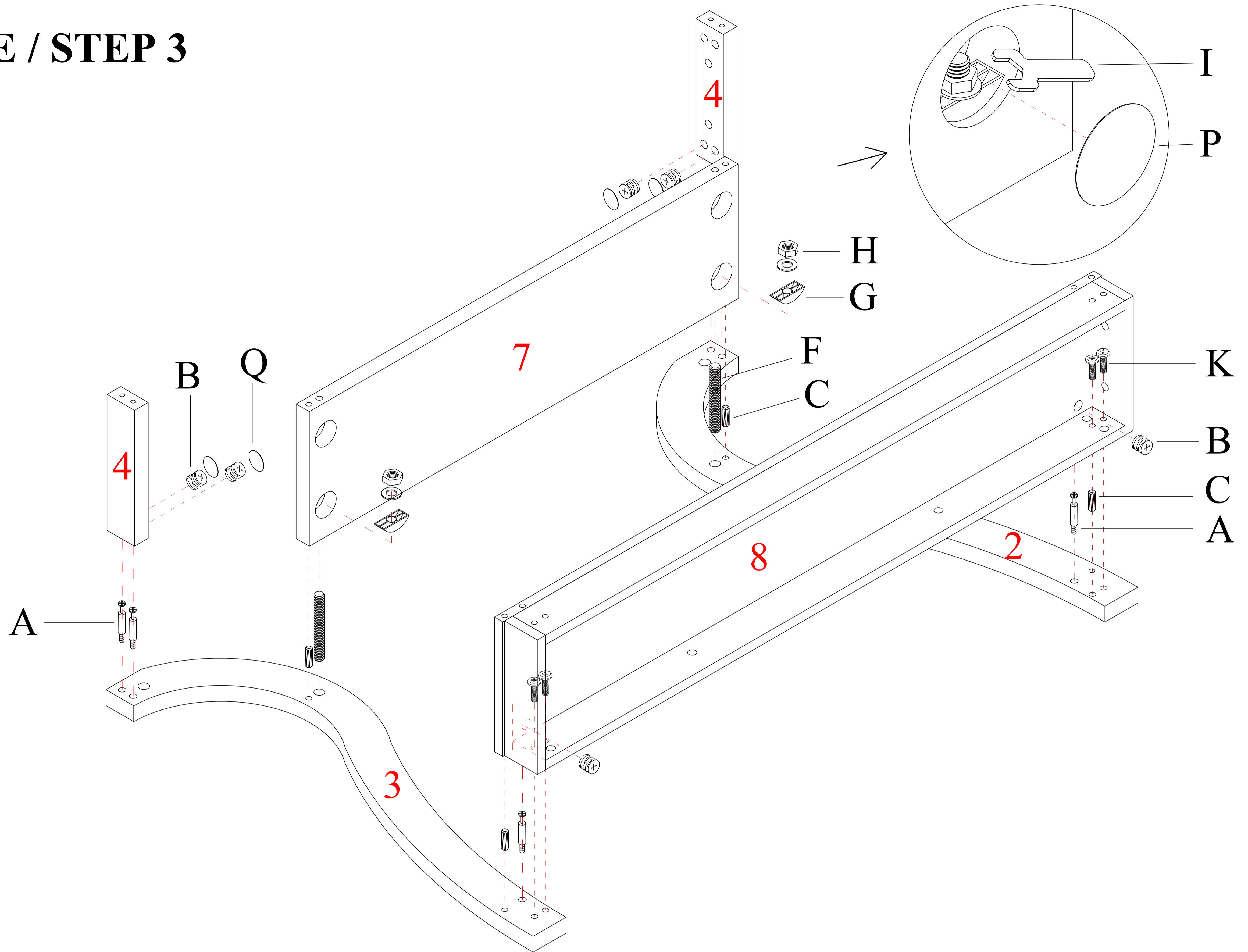

ÉTAPE / STEP 4

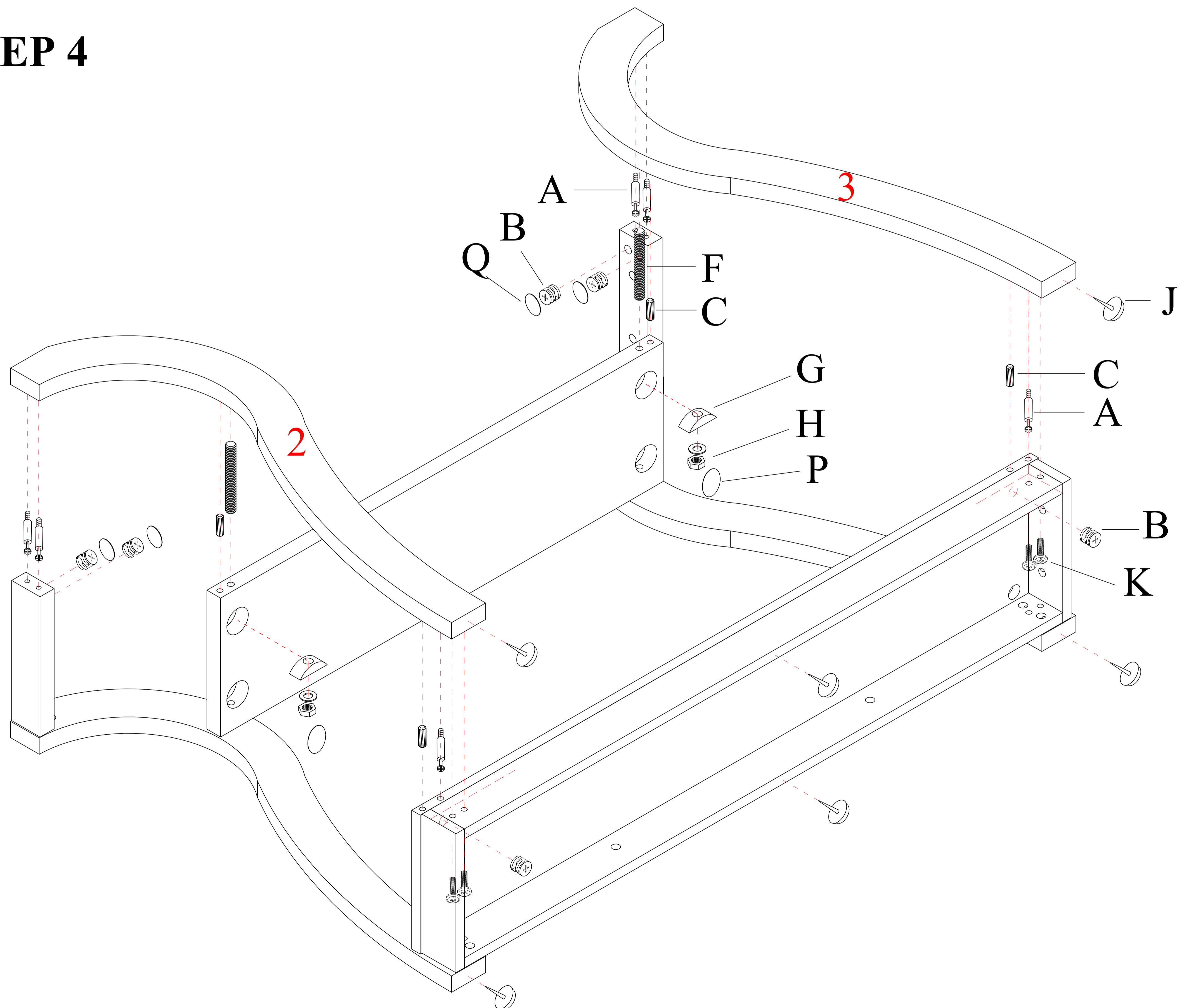

ÉTAPE / STEP 5

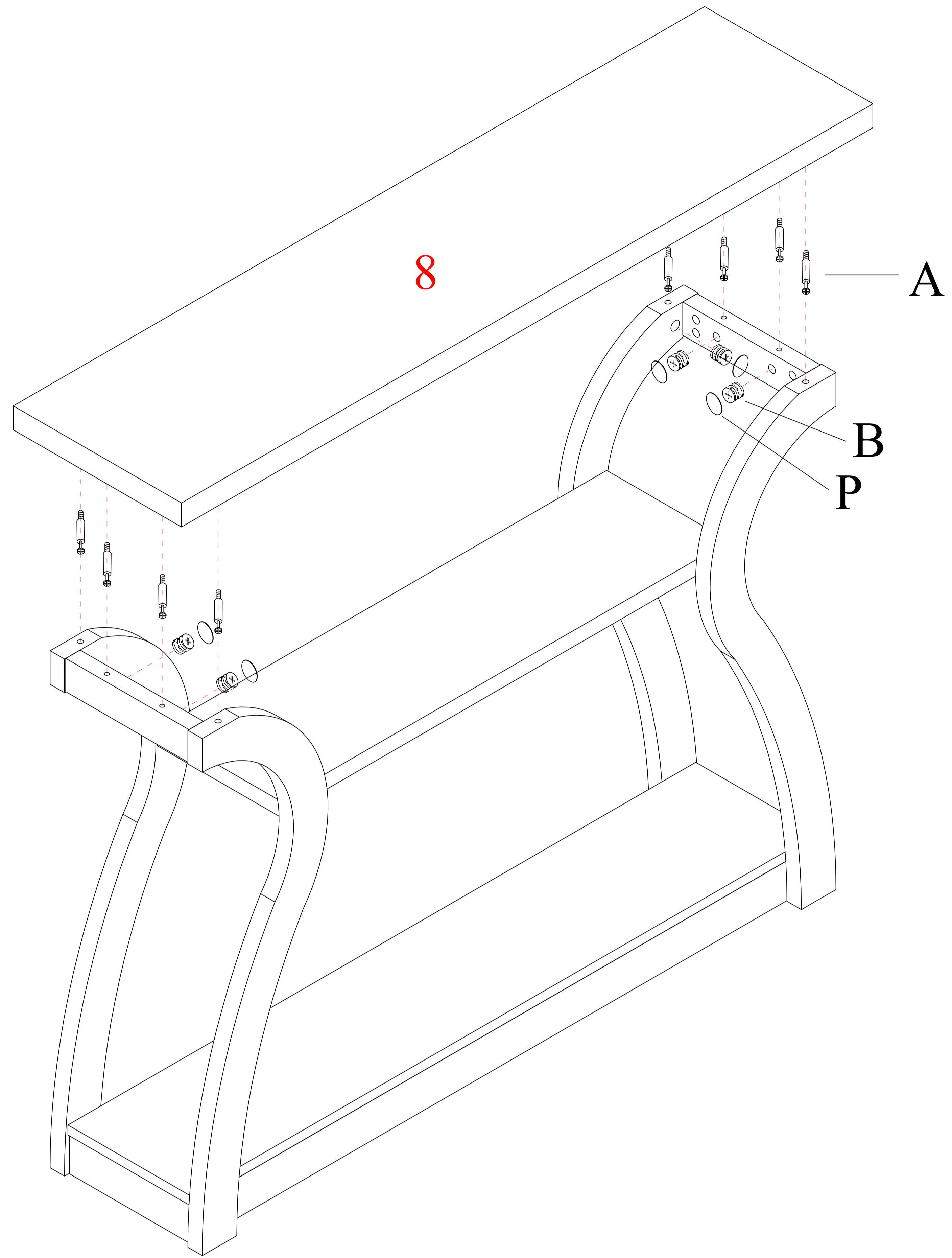

ÉTAPE / STEP 6

