

ASSEMBLY INSTRUCTION

SKU CODE: N752P405933

INSTRUCTIONS DE MONTAGE

SKU CODE: N752P405933

TABLE

TABLE DE SALLE À MANGER

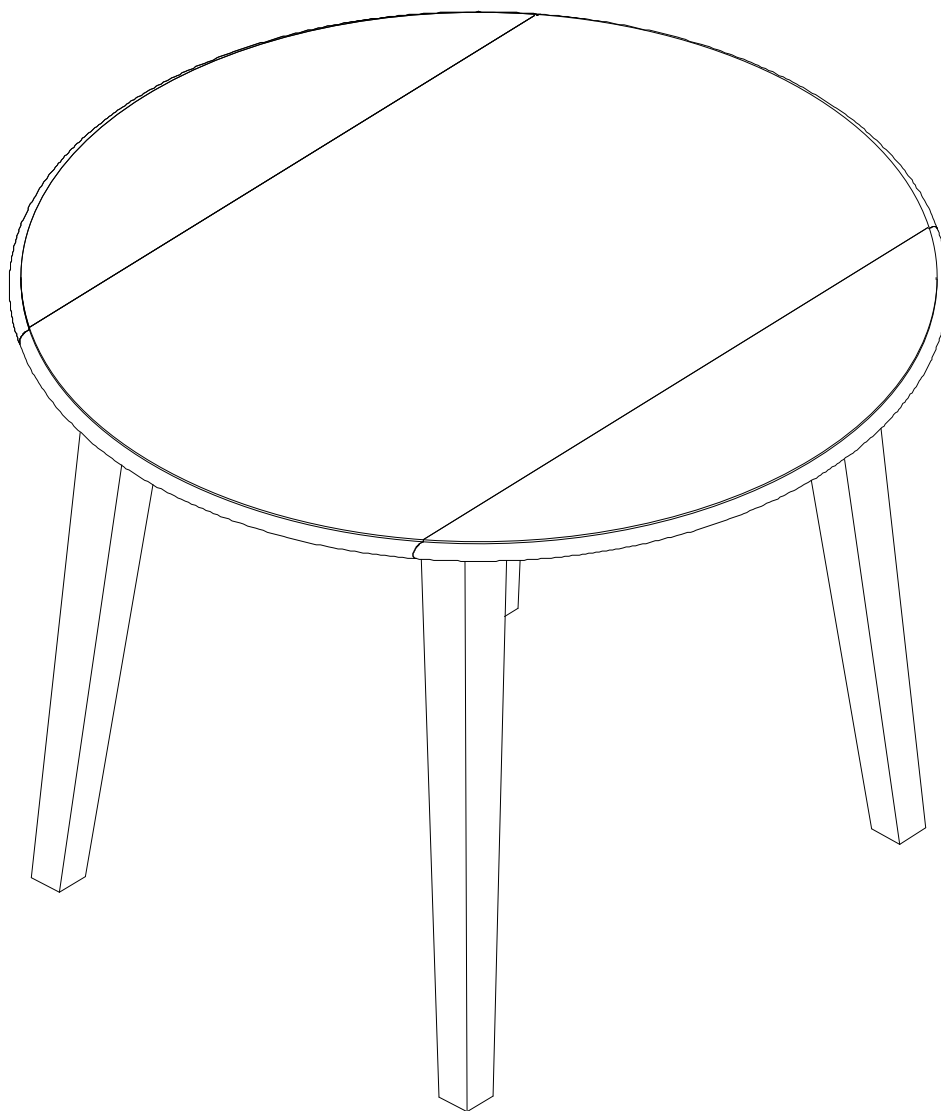



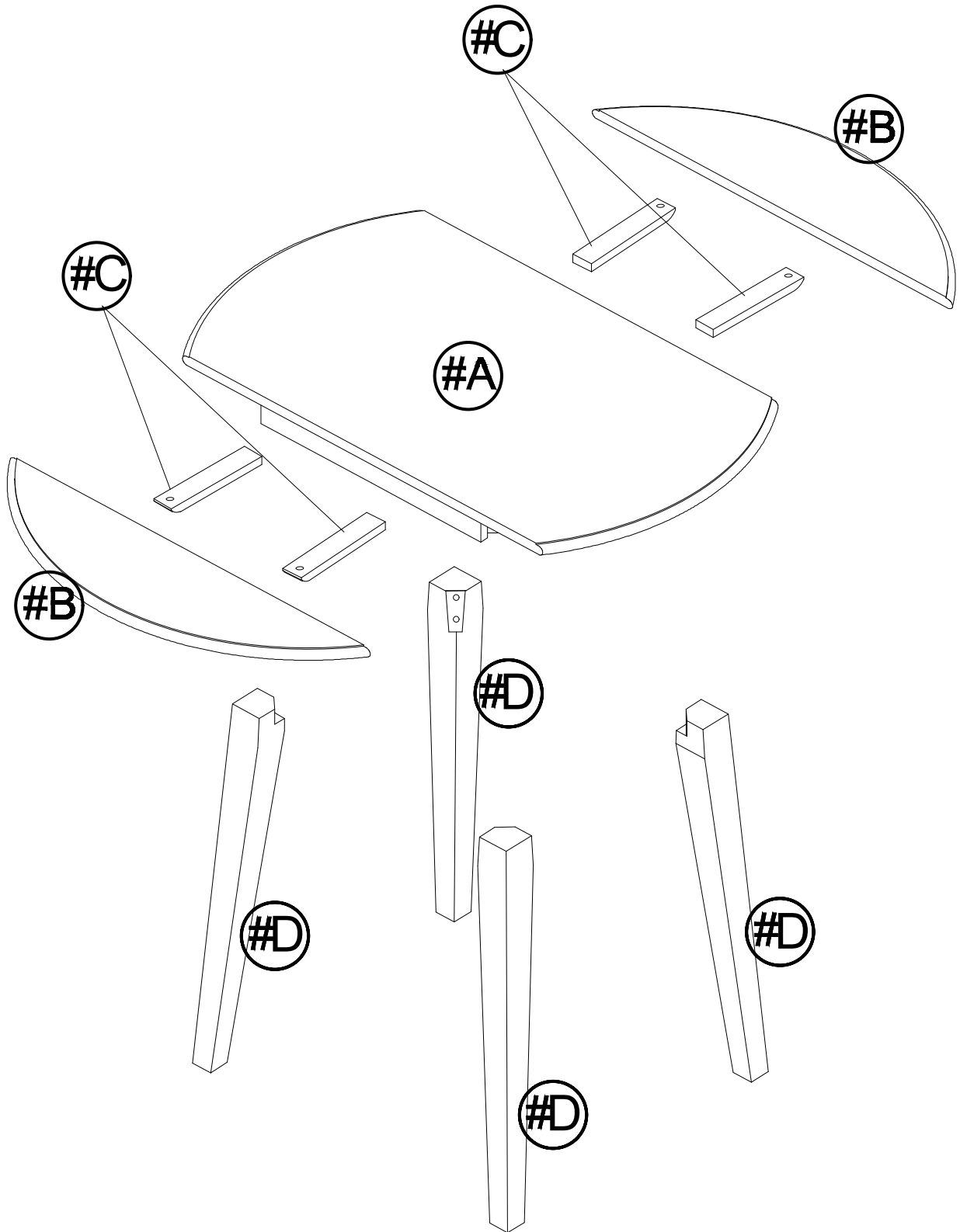

Detail View
(Vue détaillée)

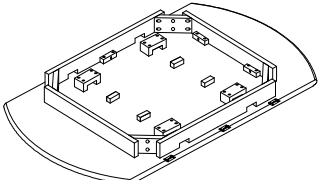
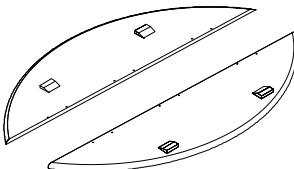
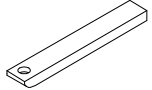
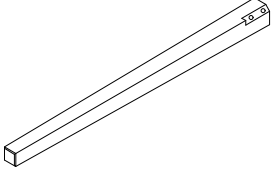

Part List :
(Liste des pièces)
N752P405933

<p>A</p>  <p>Table top-1pc Plateau de table -1pc</p>	<p>B</p>  <p>Leaf -2pcs Rallonge de table - 2pcs</p>	<p>C</p>  <p>Support bar - 4pcs Barre de renfort - 4pcs</p>
<p>D</p>  <p>Legs - 4pcs Pied de table - 4pcs</p>		

Hardware List:
(Liste du matériel)
N752P405933

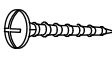
<p>1</p>  <p>Ø5/16" x 55mm Bolt=8pcs Boulon =8pcs</p>	<p>2</p>  <p>Ø5/16" Lock Washer =8pcs Rondelle élastique =8pcs</p>	<p>3</p>  <p>Ø5/16" Flat washers =8pcs Rondelles plates =8pcs</p>
<p>4</p>  <p>K4mm Allen key - 1pc clé Allen -1pc</p>	<p>5</p>  <p>#3.5 x 15mm Screw =12pcs Vis =12pcs</p>	

PLEASE BE CAREFUL DO NOT DAMAGE THE HOLE POSITION WHEN YOU USE POWER TOOLS !
(FAITES ATTENTION À NE PAS ENDOMMAGER LA POSITION DU TROU LORSQUE VOUS UTILISEZ DES OUTILS ÉLECTRIQUES !)

STEP 1:
(ÉTAPE 1)

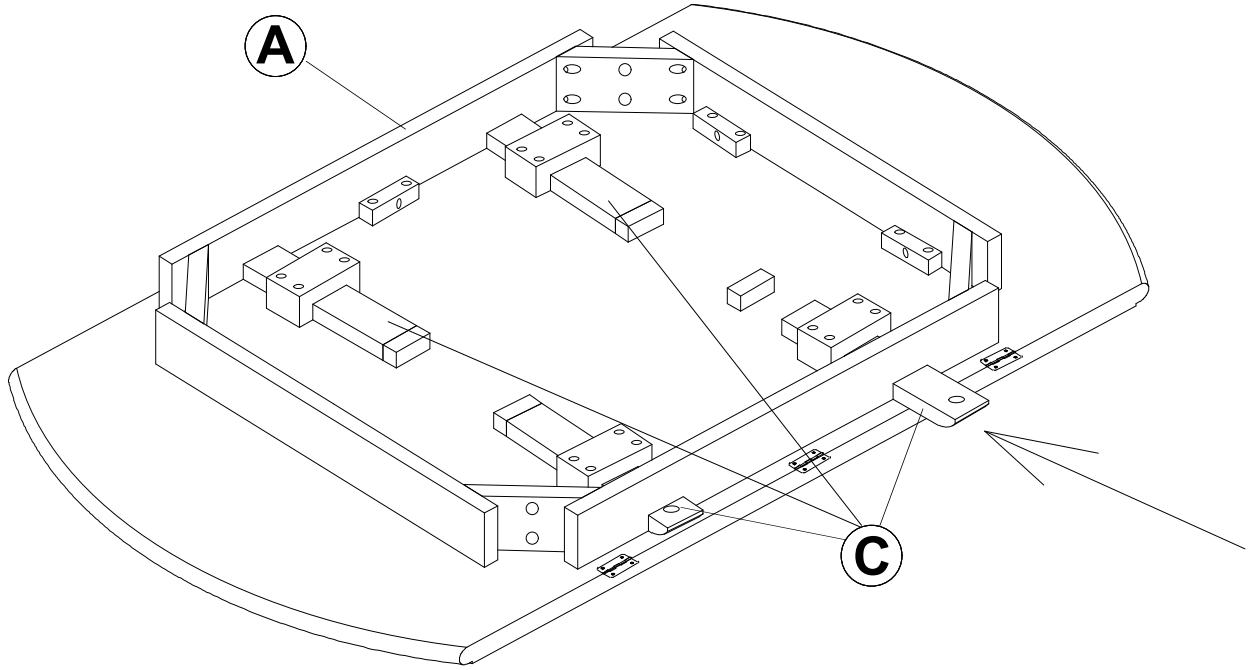



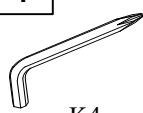

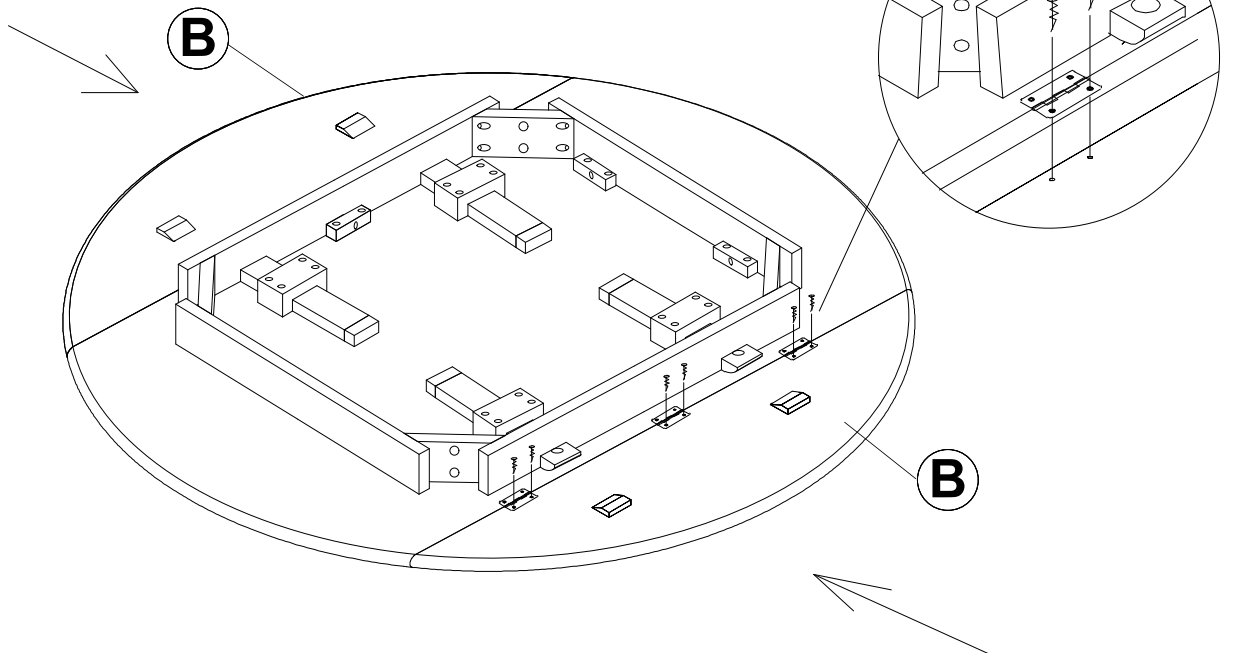
STEP 2:
(ÉTAPE 2)

5	4
	
#3.5 x 15mm 12pcs	K4 1pc

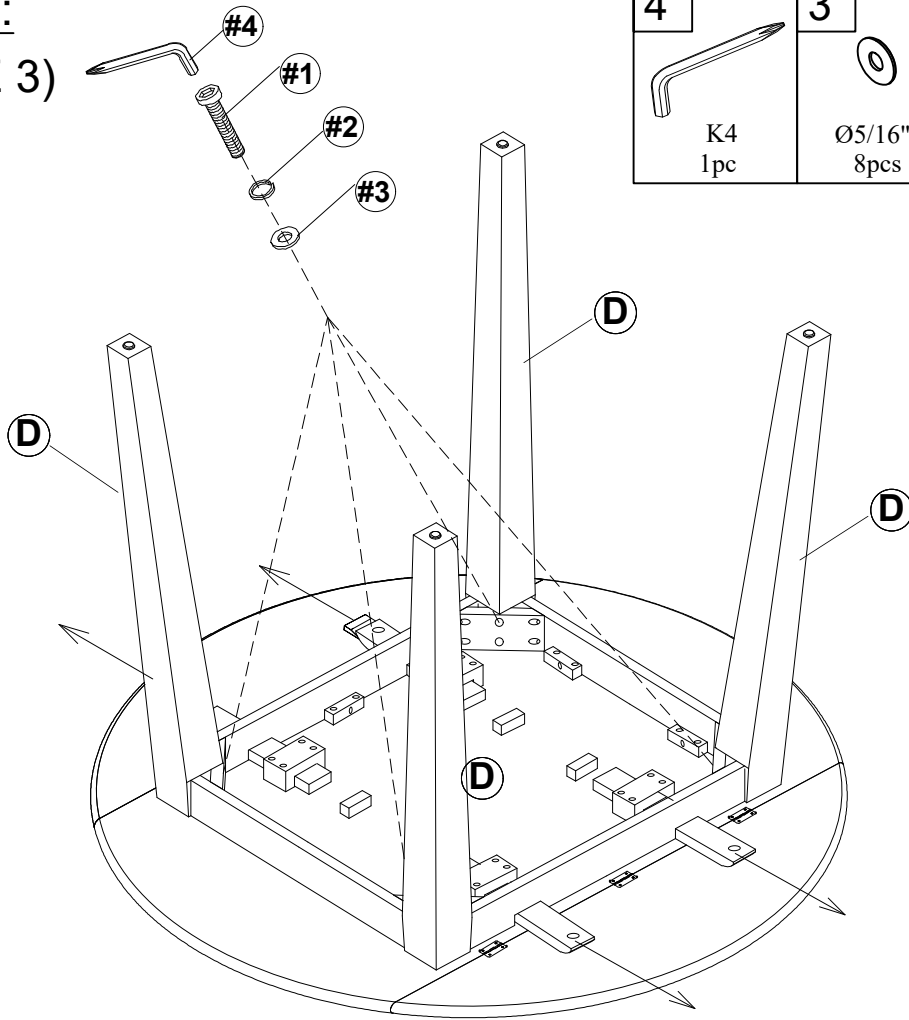

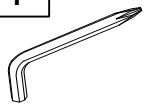
STEP 3:
(ÉTAPE 3)



<p>4</p>  <p>K4 1pc</p>	<p>3</p>  <p>Ø5/16" 8pcs</p>	<p>2</p>  <p>Ø5/16" 8pcs</p>	<p>1</p>  <p>Ø5/16"x55mm 8pcs</p>
---	--	--	---

STEP 4:
(ÉTAPE 4)

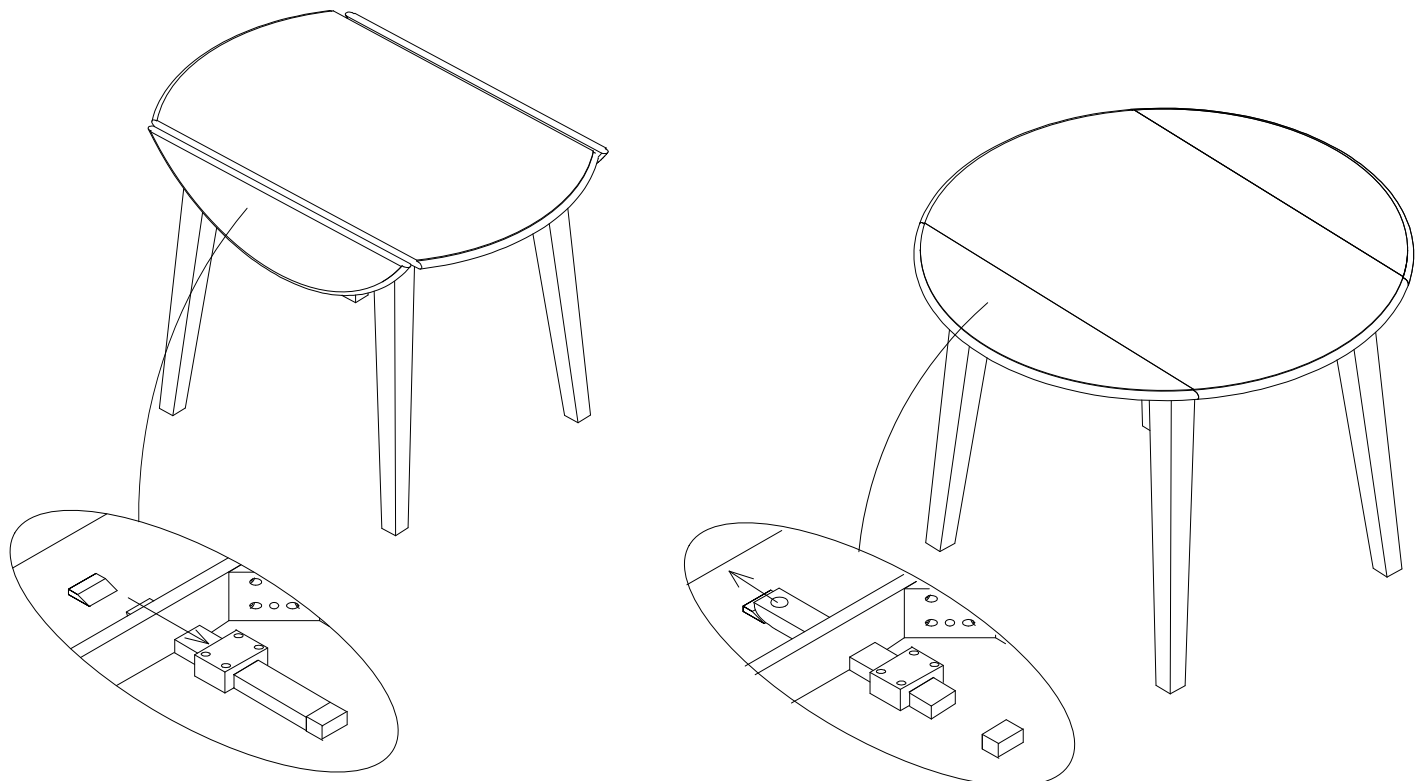

STEP 5:
(ÉTAPE 5)

COMPLETED ASSEMBLY

