

ASSEMBLY INSTRUCTIONS

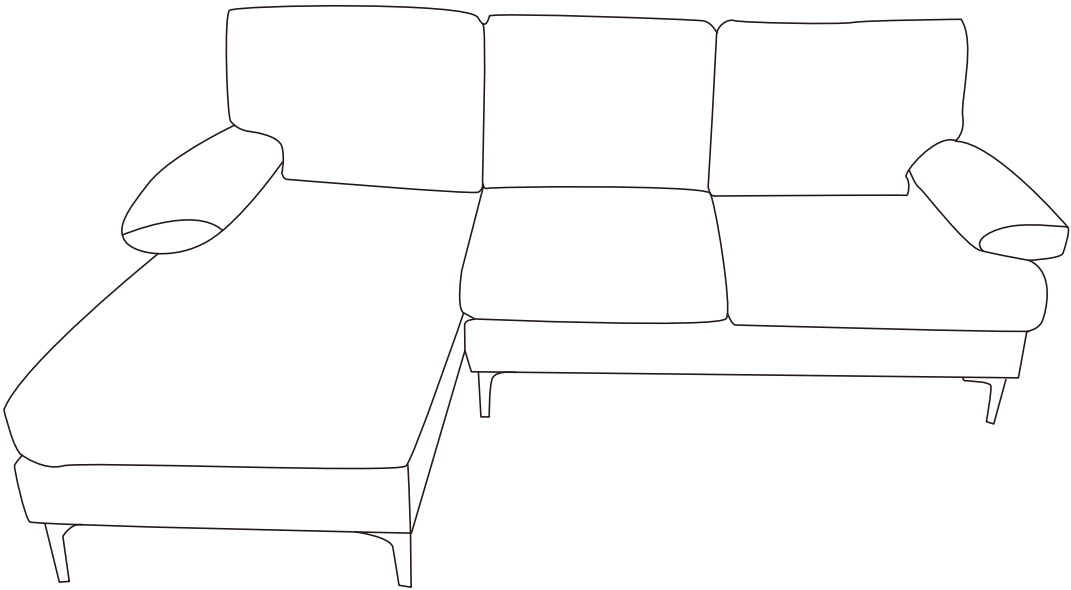

PARTS LIST

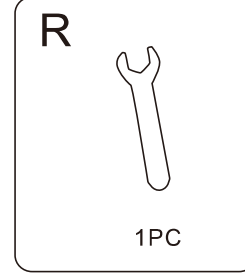
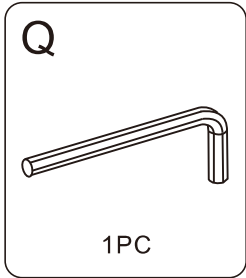
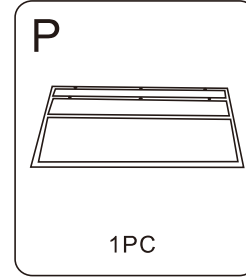
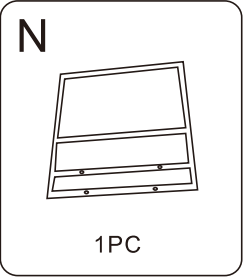
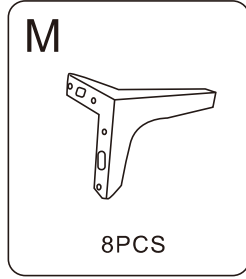
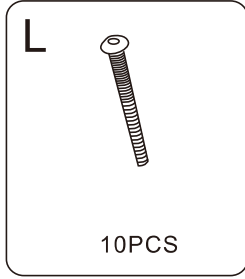
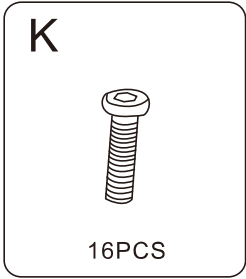
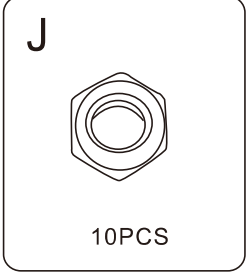
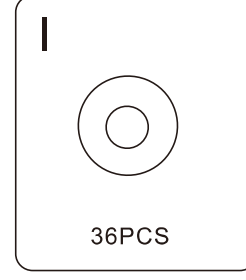
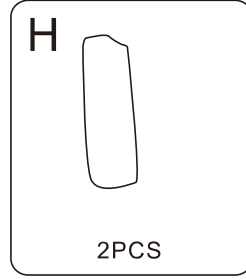
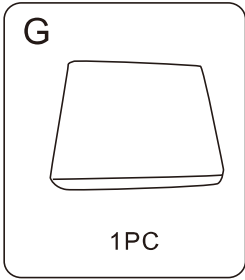
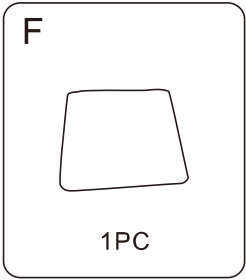
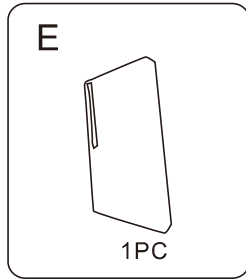
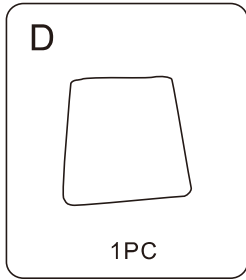
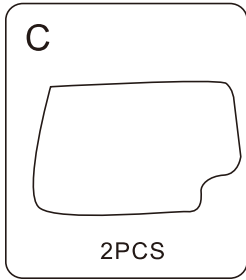
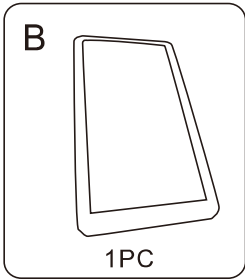
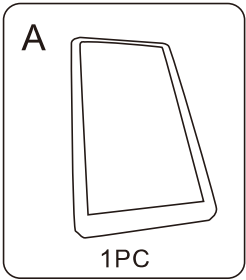

Step 1

Assemble the legs

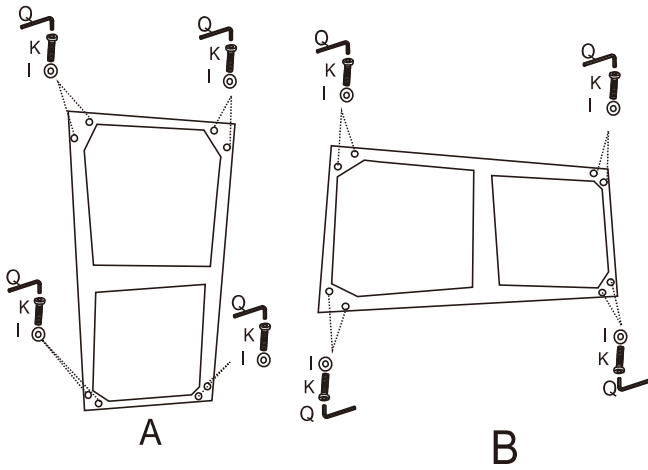

Step 2

Align the back frame and seat frame, put the washer and screw, insert to the hole, put the washer and tighten nut with wrench

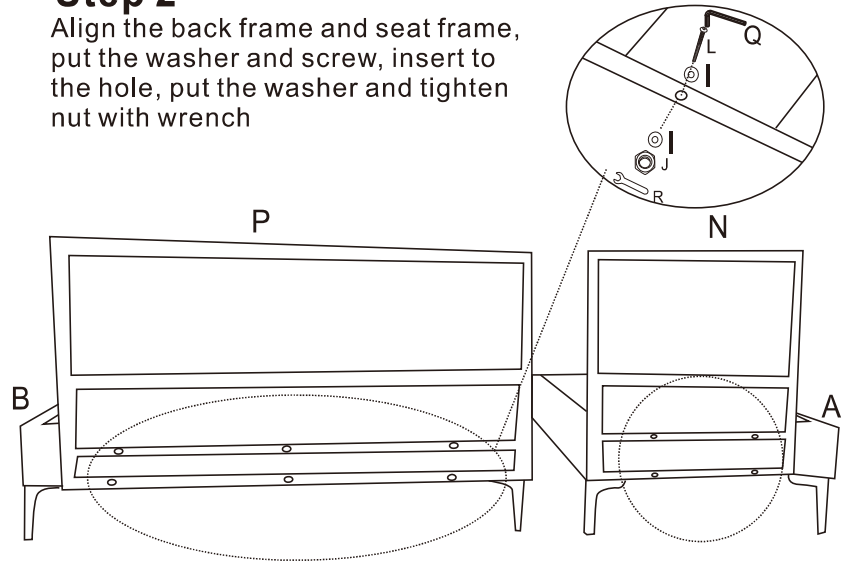

Step 3

Put the cushions on sofa, press them to stuck with the velcro

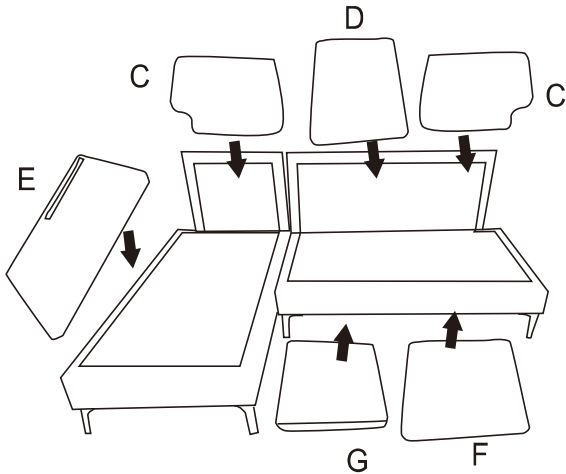

Step 4

Zip the armrest

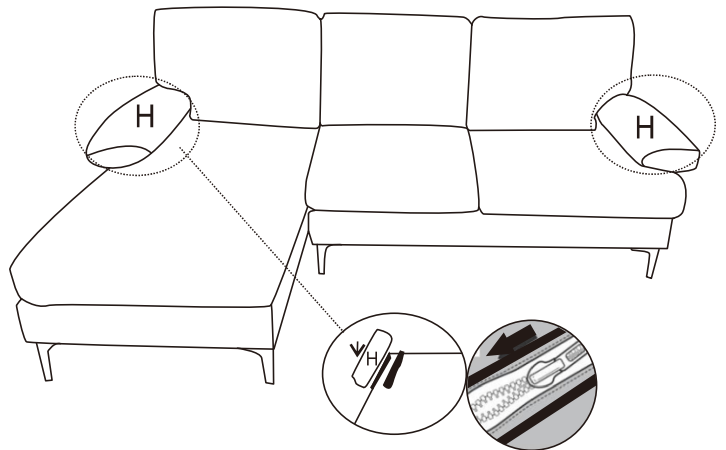

Step 5

Connect the sofa and chaise

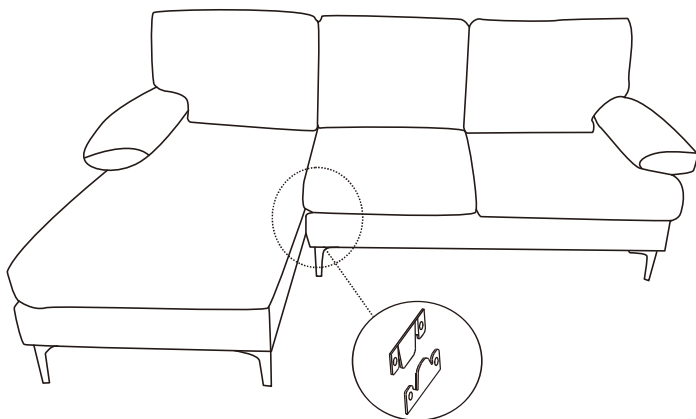

Step 6

Assembly is finished

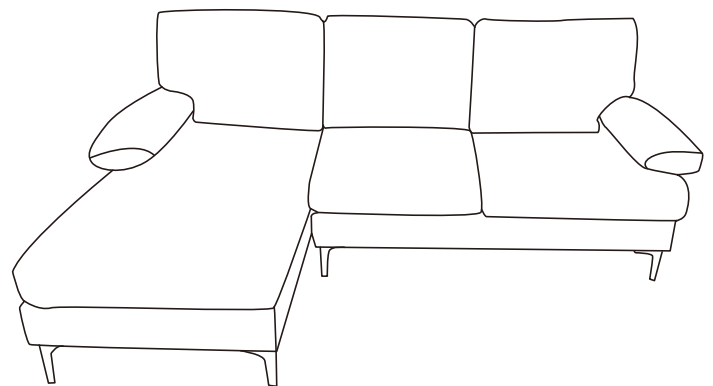

TIPS:

- 1, Please do not open the compress packaging until your sofa frame is completely assembled.**
- 2, Compress cushions or pillows need to fully fluffed within 72 hours for your perfect use.**
- 3, Please keep children away from plastic bag or any small pieces of stuff.**
- 4, After assembly is completed, don't forget to pat the back cushions and seat cushions, make them recovering better. And wait 72 hours for fully rebound.**

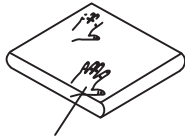

Pat and tidy the cushions

- 5, Cushions should be regularly maintained for perfect use.**

STEPS for compressed pack:

- (1) open the carton -- (2) take out the compressed pack -- (3) cut from edge and take out the cushion -- (4) Put the cushion on floor -- (5) Pat and tidy the cushion --(6) Wait to rebound completely after 72 hours.**

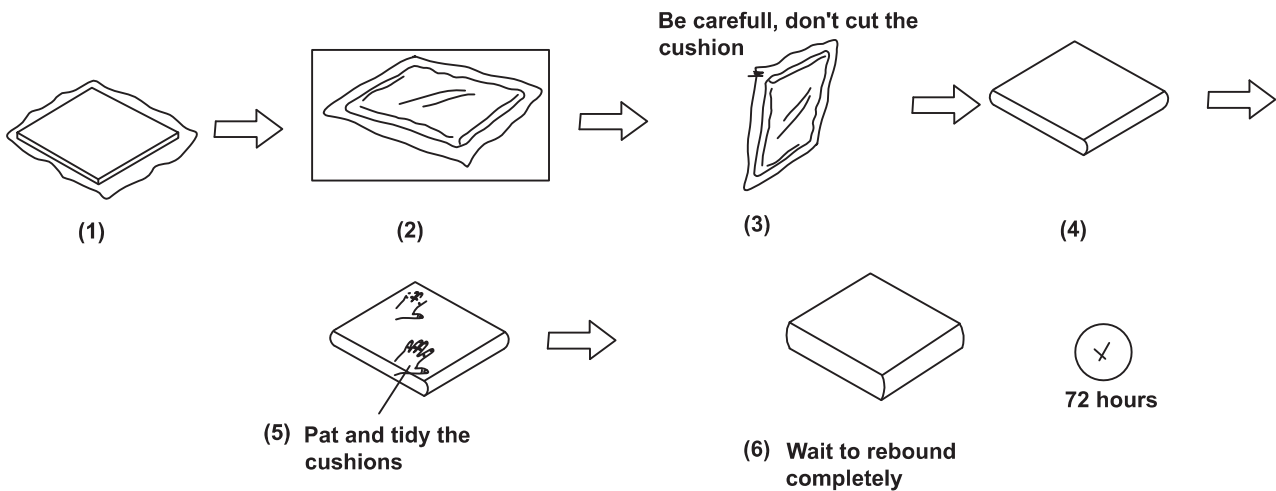

CAUTION:

PLEASE DO NOT OPEN COMPRESSED PLASTIC CUSHION BACK UNTIL YOUR SOFA FRAME IS COMPLETELY ASSEMBLED, OTHERWISE, IT CAN'T BE REPACKED IN ORIGINAL PACKING WAY TO RETURN.