

Instruction Manual

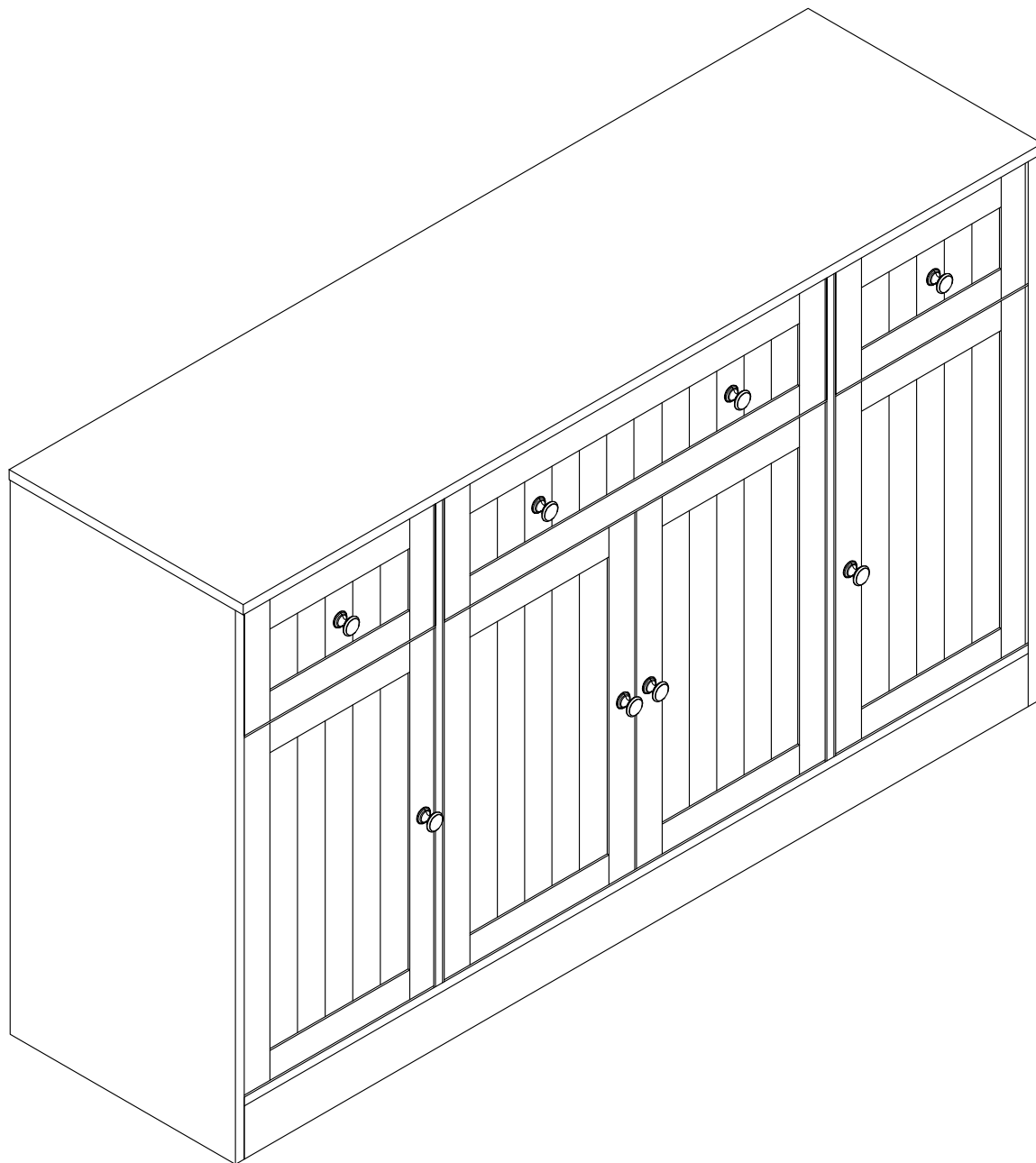

Cabinet

EN

Thank you for purchase on our products. Please contact us if you have difficulty with assembly or need replacement parts. Our customer service is here to assist you. Please attach your User Name or Order ID so that we can assist you better.

WARNING

Serious or fatal injury may occur from unexpected assembly or use.

1. During the assembly process, keep all parts away from babies or children.
2. Always securely fix this product to the wall. Make sure the wall area to be drilled is free from hidden electrical wires, water and gas pipes.
3. Use of tip-over restraints may only reduce, but not eliminate the risk of tip-over.
4. Unless specially designed to accommodate, do not set heavy objects on top of this product.
5. Place the heaviest items on the lowest shelf.
6. Never allow children to climb or bang on drawers, doors or shelves.

DE



Vielen Dank für Ihren Kauf von uns Produkten. Bitte kontaktieren Sie uns, wenn Sie Probleme mit Montage haben oder Ersatzteile benötigen. Wir Kundenservice ist für Sie da. Bitte geben Sie Ihren Benutzernamen oder Ihre Bestellnummer an, damit wir Sie besser unterstützen können.

WARNUNG





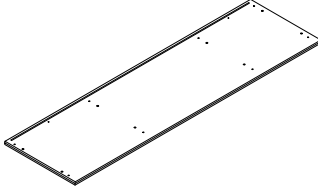
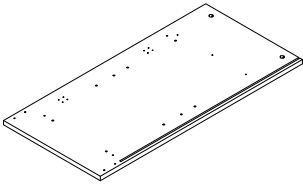
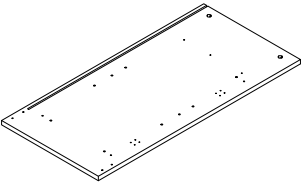
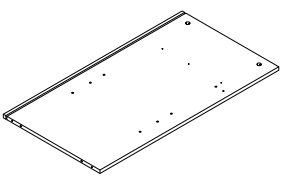
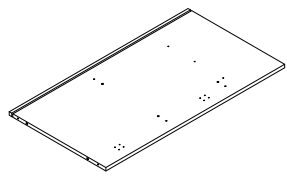
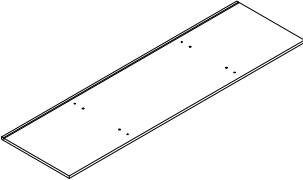
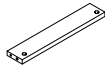
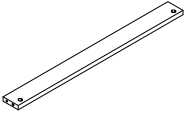
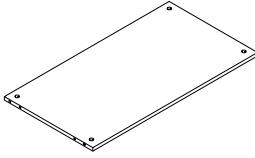
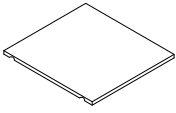
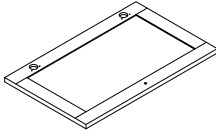
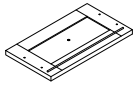
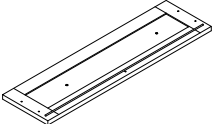
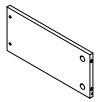

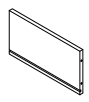
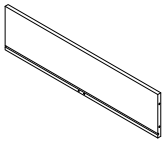
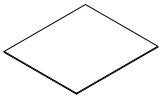
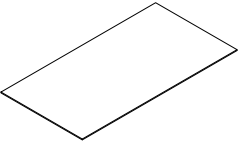
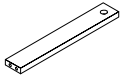
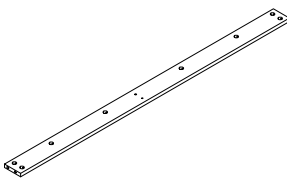
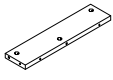
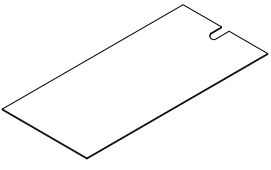
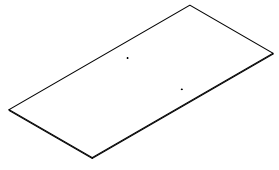



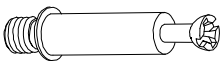

Bei unerwarteter Montage oder Verwendung können schwere oder tödliche Verletzung auftreten.

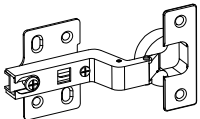
1. Legen Sie in den Montageprozess alle Teile weg von Babys oder Kindern.
2. Stellen Sie sicher, dass der gebohrte Wandbereich frei von verborgenen Stromkabeln, Wasser- und Gasleitungen ist, wenn Sie dieses Produkt an der Wand befestigen.
3. Die Verwendung von Kippsicherungen kann die Gefahr eines Kippens nur verringern, jedoch nicht beseitigen.
4. Setzen Sie bitte keine schweren Gegenstände auf dieses Produkt, es sei denn, dass das Produkt speziell für die Unterbringung konzipiert wird.
5. Legen Sie bitte die schwersten Gegenstände auf das unterste Regal.
6. Erlauben Sie nie Kindern, auf Schubladen, Türen oder Regale zu klettern oder zu knallen.

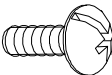
Parts List(EN) / Teile Liste(DE)

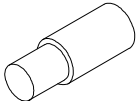
1  1PC	2  1PC	3  1PC	4  1PC
5  1PC	6  1PC	7  2PCS	8  1PC
9  1PC	10  2PCS	11  4PCS	12  2PCS
13  1PC	14  3PCS	15  3PCS	16  2PCS
17  1PC	18  2PCS	19  1PC	20  1PC
21  2PCS	22  1PC	23  2PCS	24  2PCS

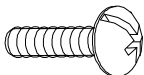
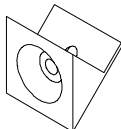
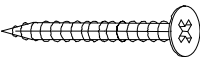
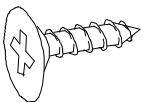

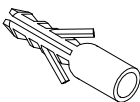
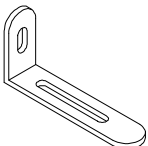
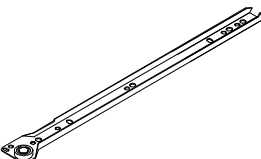
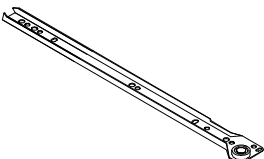
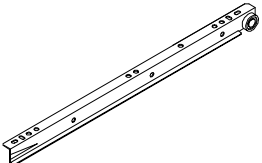
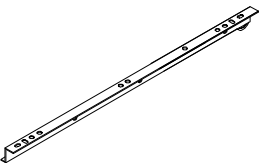
Parts List(EN) / Teile Liste(DE)

A  M6×35mm 54+2PCS	B  Ø15×10mm 54+2PCS	C  Ø6×30mm 34+2PCS	D  L710mm 1PC
E  8PCS	F  M3×14mm 12+1PCS	G  M4×10mm 4PCS	H  M4×14mm 48+2PCS
I  8+1PCS	J  8PCS	K  M4×18mm 4PCS	L  12+1PCS
M  M4×35mm 20+2PCS	N  M3.5×12mm 36+2PCS	O  M4×12mm 2PCS	P  M3×12mm 4PCS
Q  M6×30mm 2PCS	R  2PCS	CL  L300mm 3PCS	CR  L300mm 3PCS
DL  L300mm 3PCS	DR  L300mm 3PCS		

Assembly Steps(EN) / Montageschritte(DE)

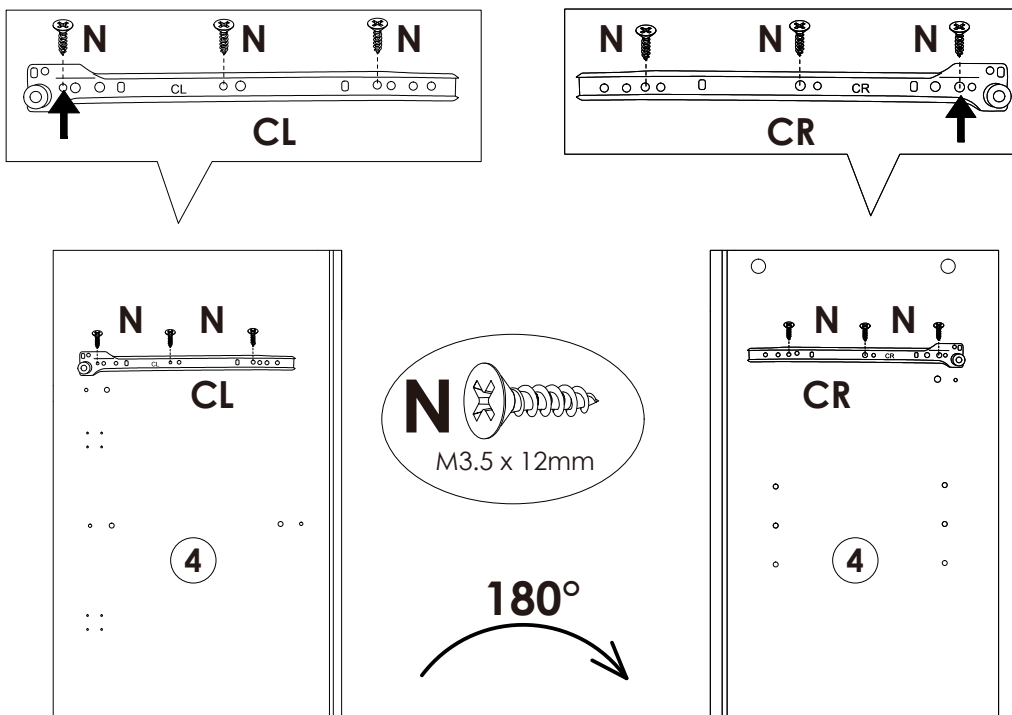
STEP 1







	N x 6PCS
	CL x 1PC
	CR x 1PC

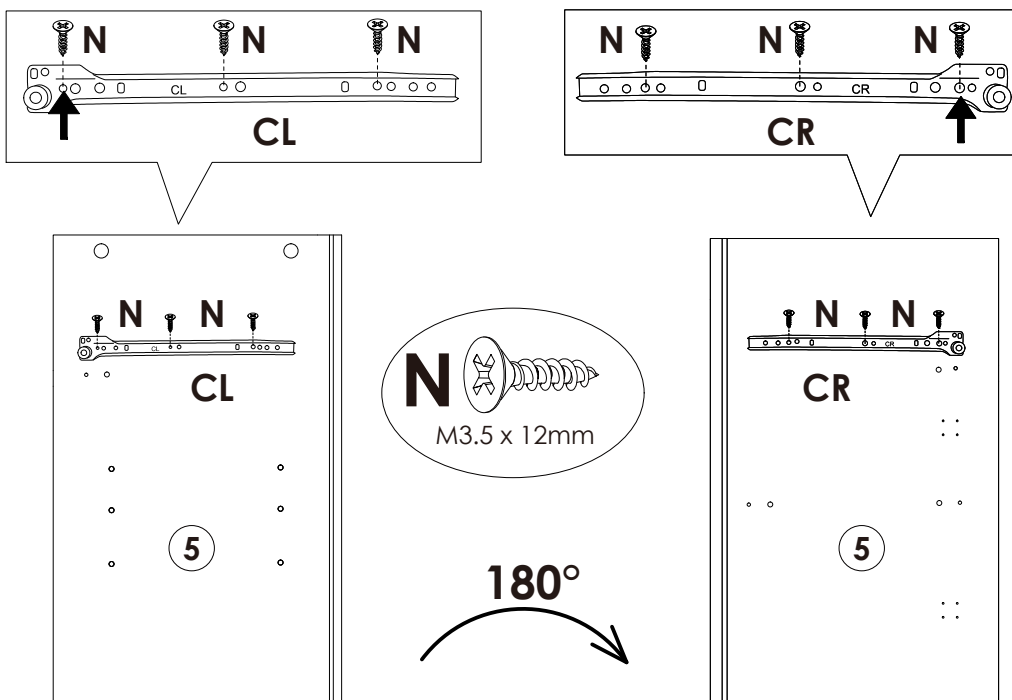

Turn over part ④ to install the other side.

STEP 2



	N x 6PCS
	CL x 1PC
	CR x 1PC



Turn over part ⑤ to install the other side.

Assembly Steps(EN) / Montageschritte(DE)

STEP 3

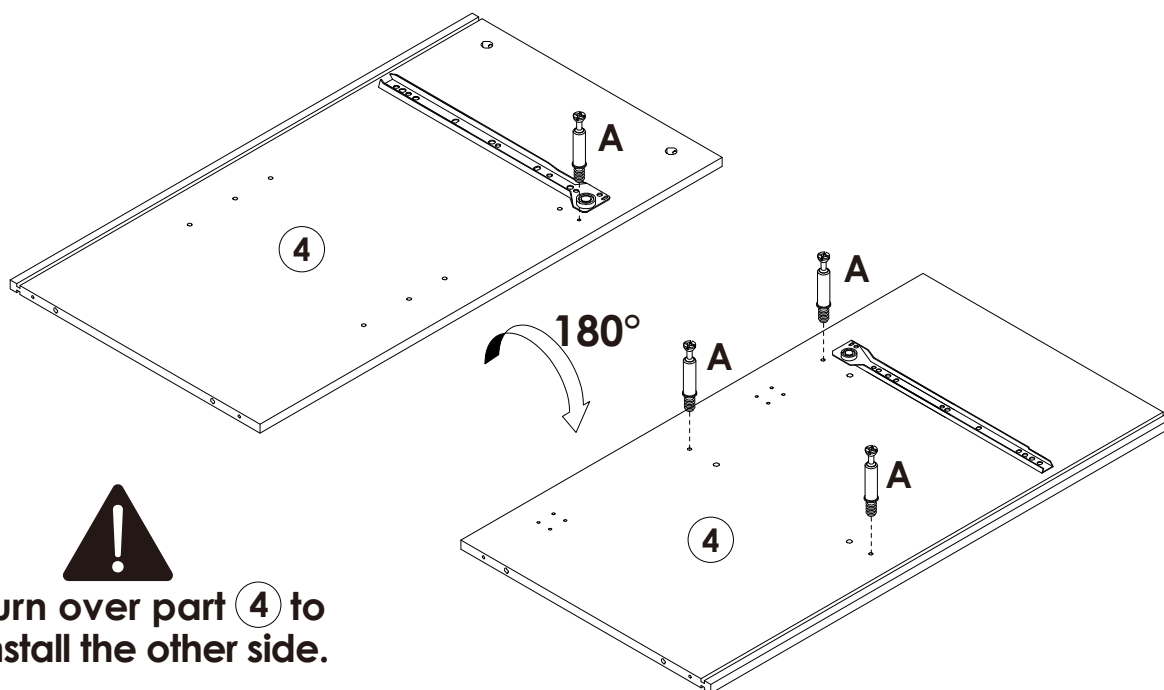

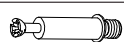

Turn over part ④ to
install the other side.

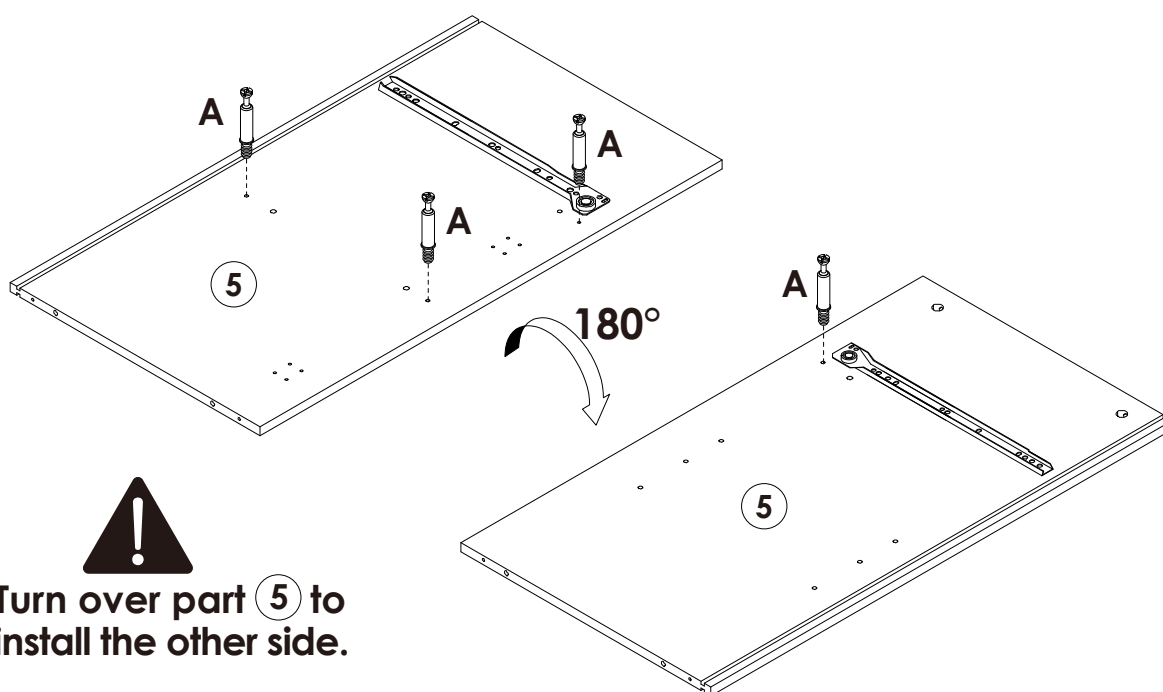

A x 4PCS

STEP 4



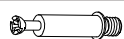

Turn over part ⑤ to
install the other side.



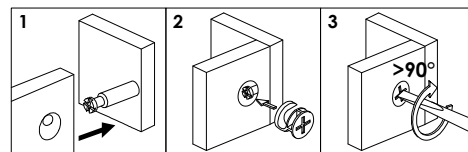
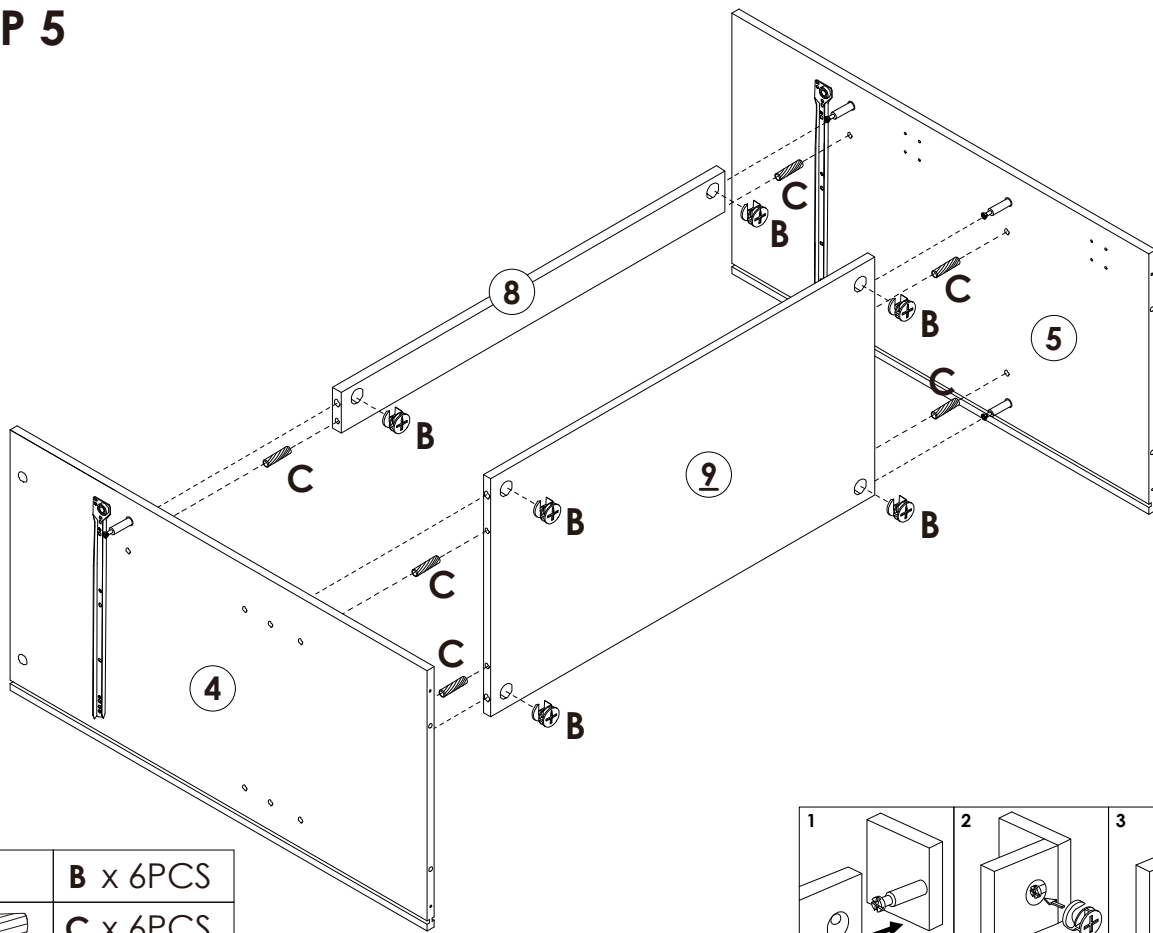

A x 4PCS

Assembly Steps(EN) / Montageschritte(DE)

STEP 5



	B x 6PCS
	C x 6PCS

STEP 6

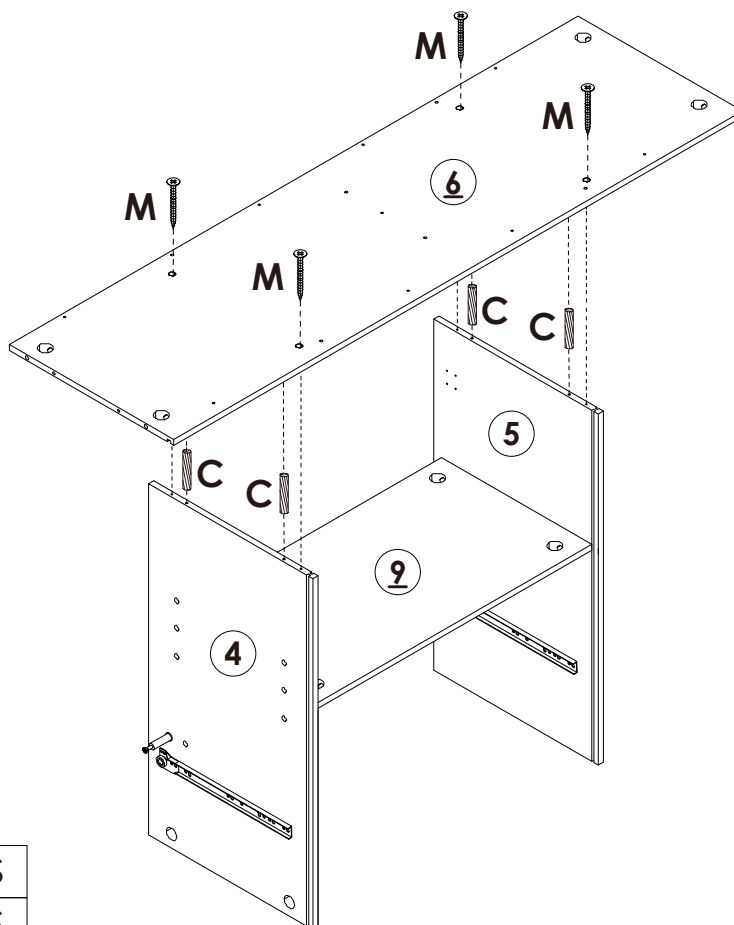

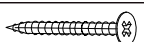
	C x 4PCS
	M x 4PCS

Assembly Steps(EN) / Montageschritte(DE)

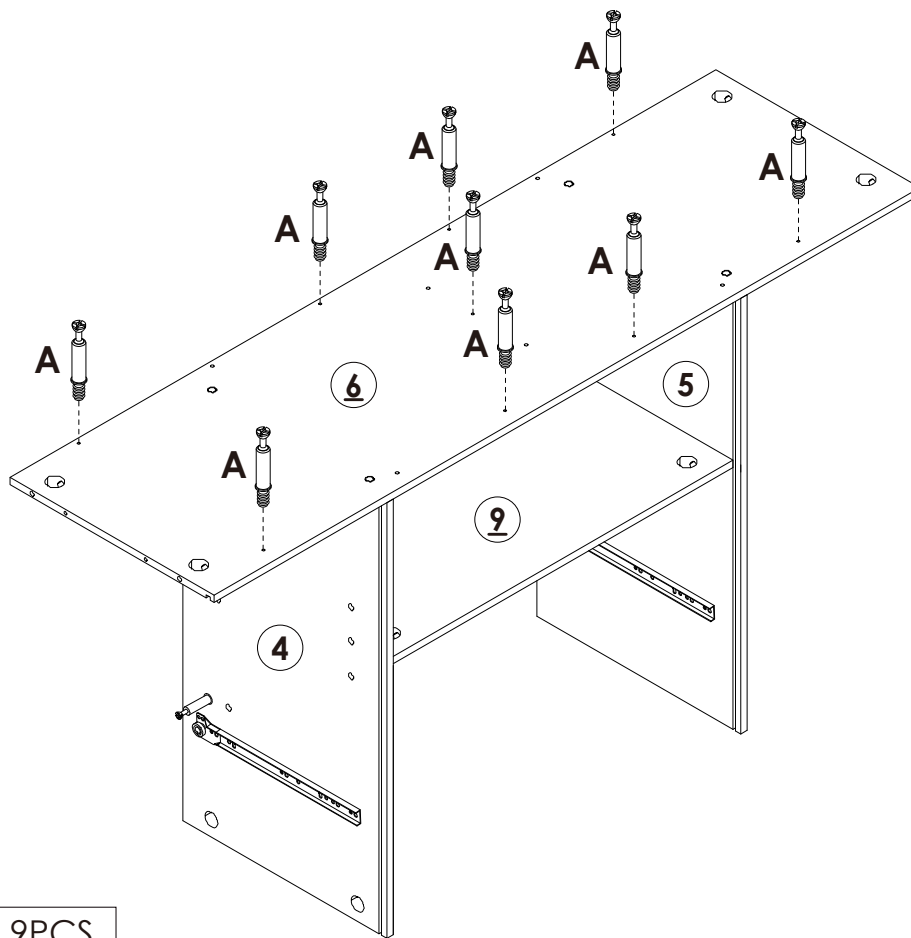

STEP 7

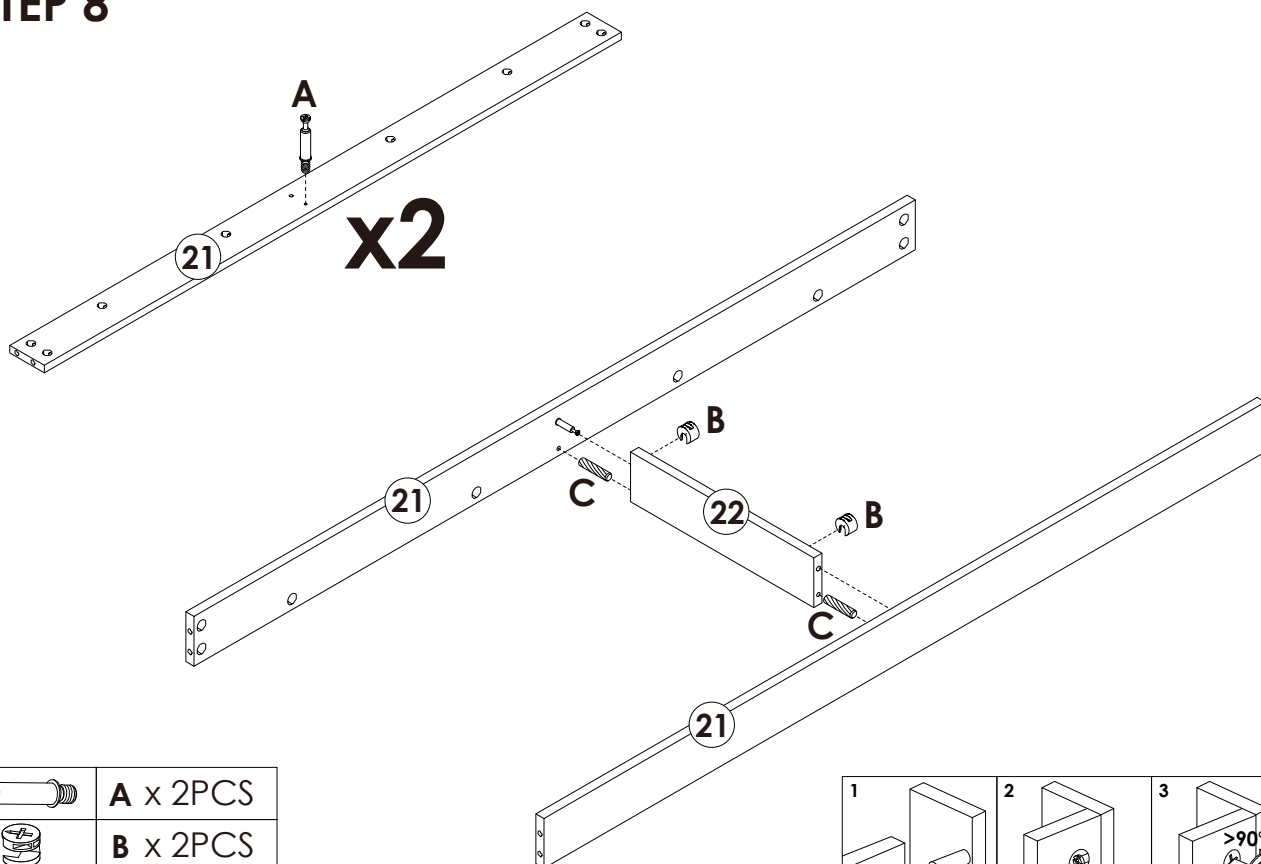

 **A x 9PCS**

STEP 8





 **A x 2PCS**
 **B x 2PCS**
 **C x 2PCS**

Assembly Steps(EN) / Montageschritte(DE)

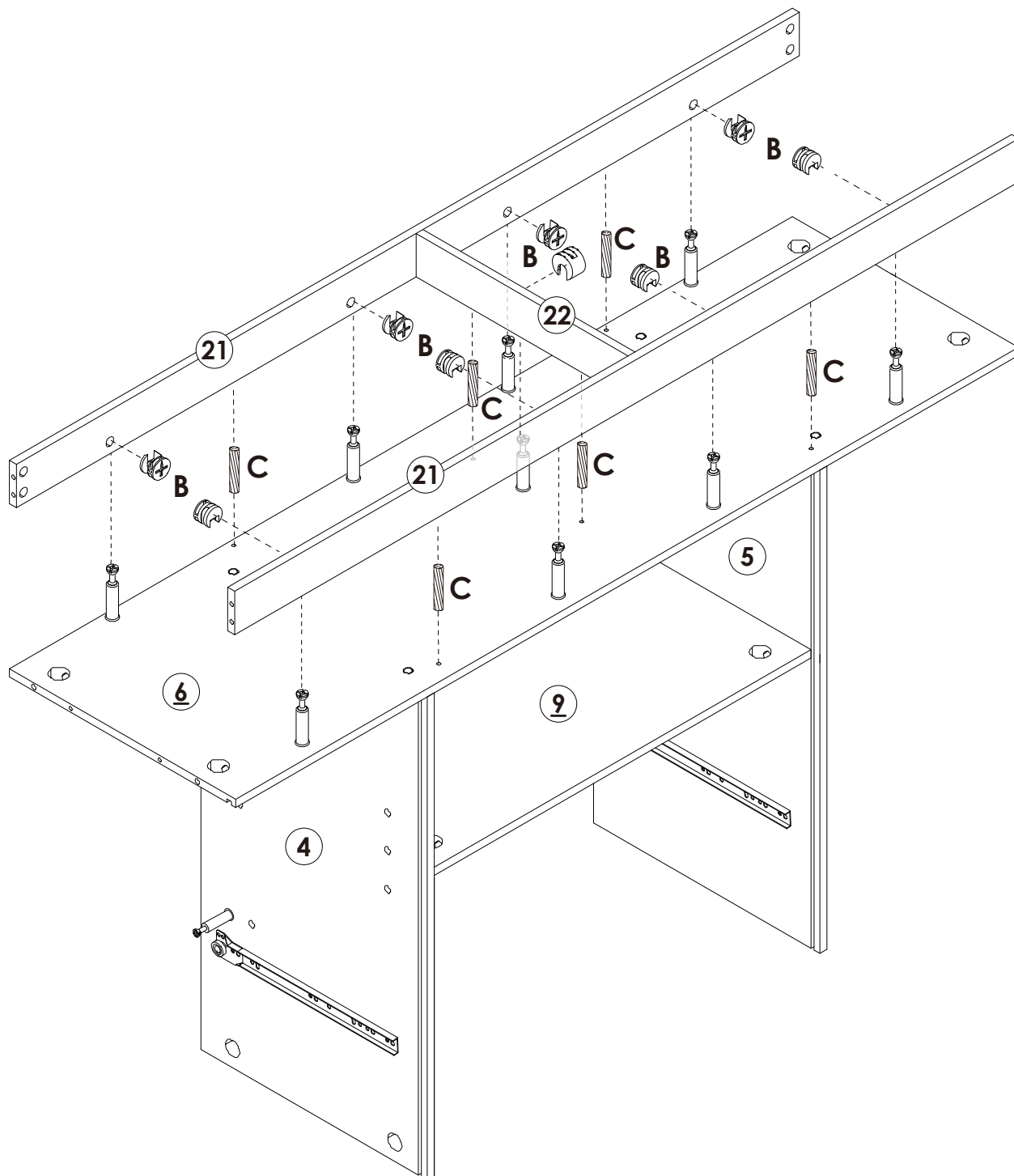
STEP 9





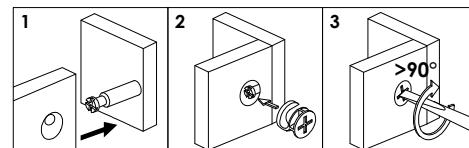

	B x 9PCS
	C x 6PCS

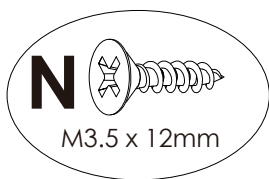
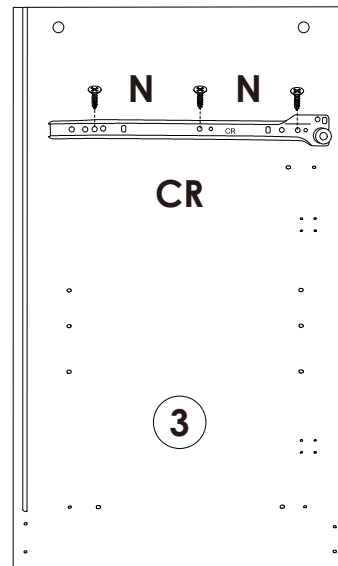
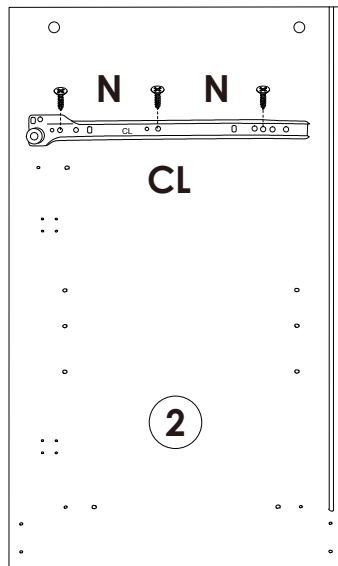
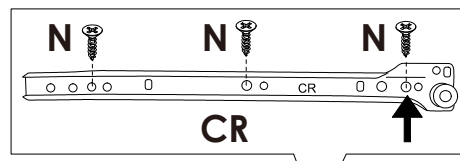
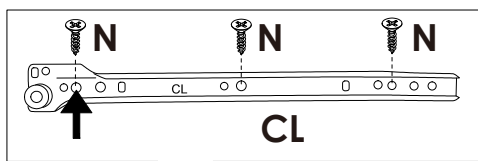

Assembly Steps(EN) / Montageschritte(DE)

STEP 10



	N x 6PCS
	CL x 1PC
	CR x 1PC

STEP 11

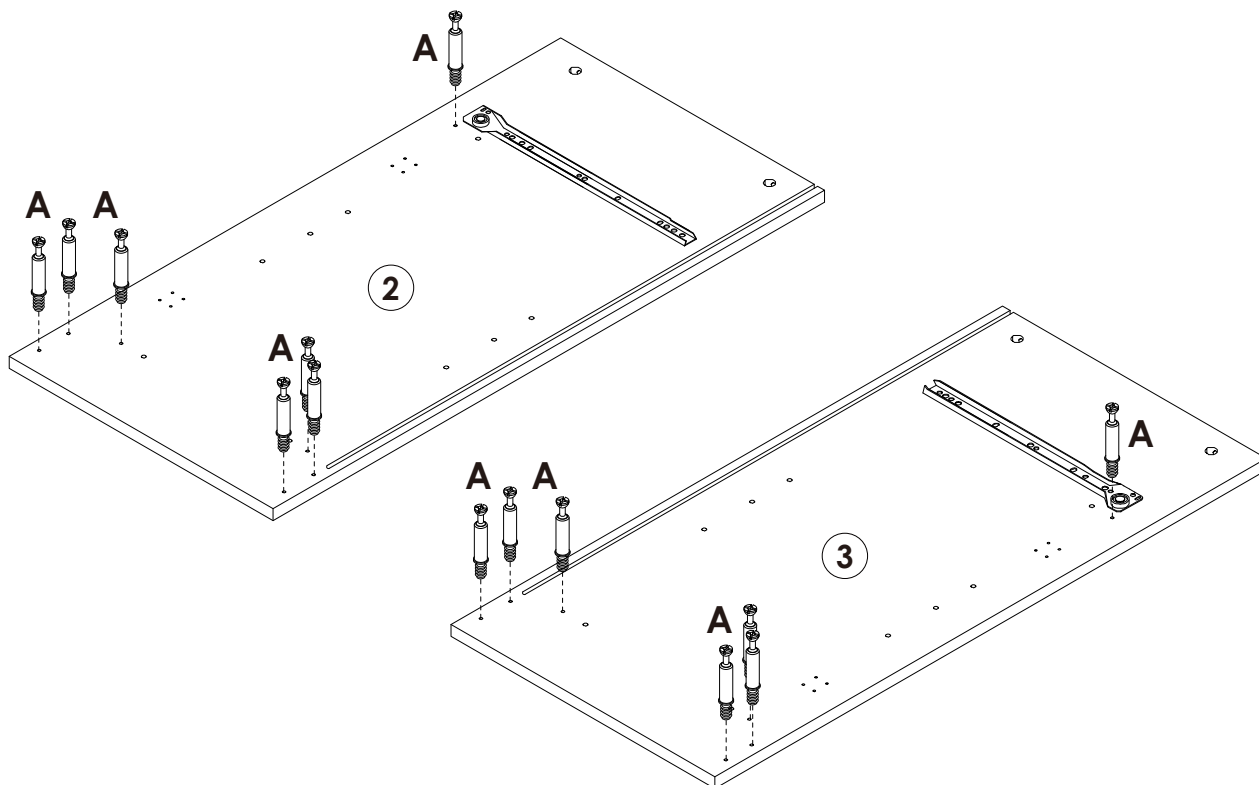



	A x 14PCS
---	------------------

Assembly Steps(EN) / Montageschritte(DE)

STEP 12

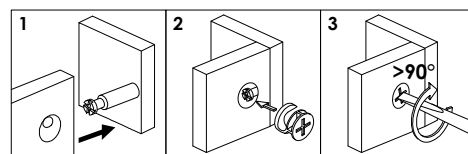
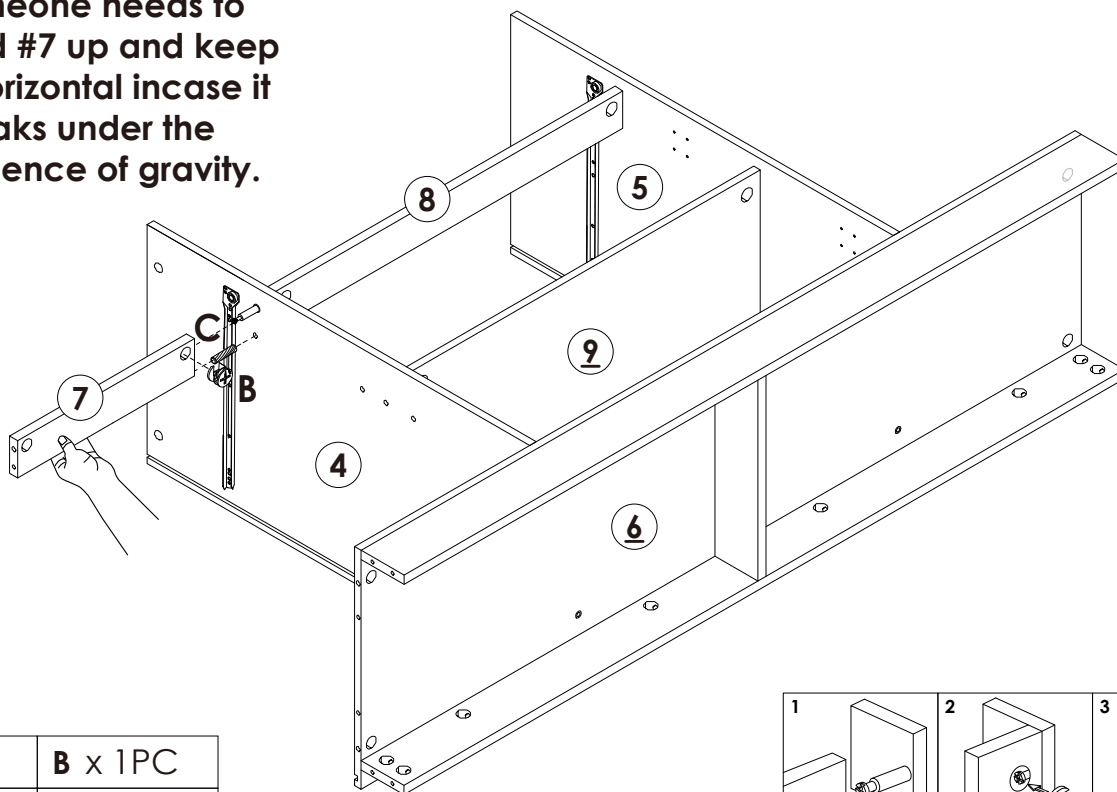

Someone needs to hold #7 up and keep it horizontal incase it breaks under the influence of gravity.

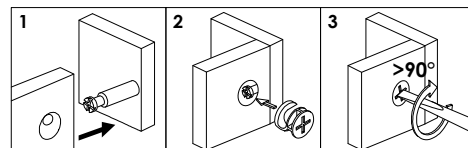
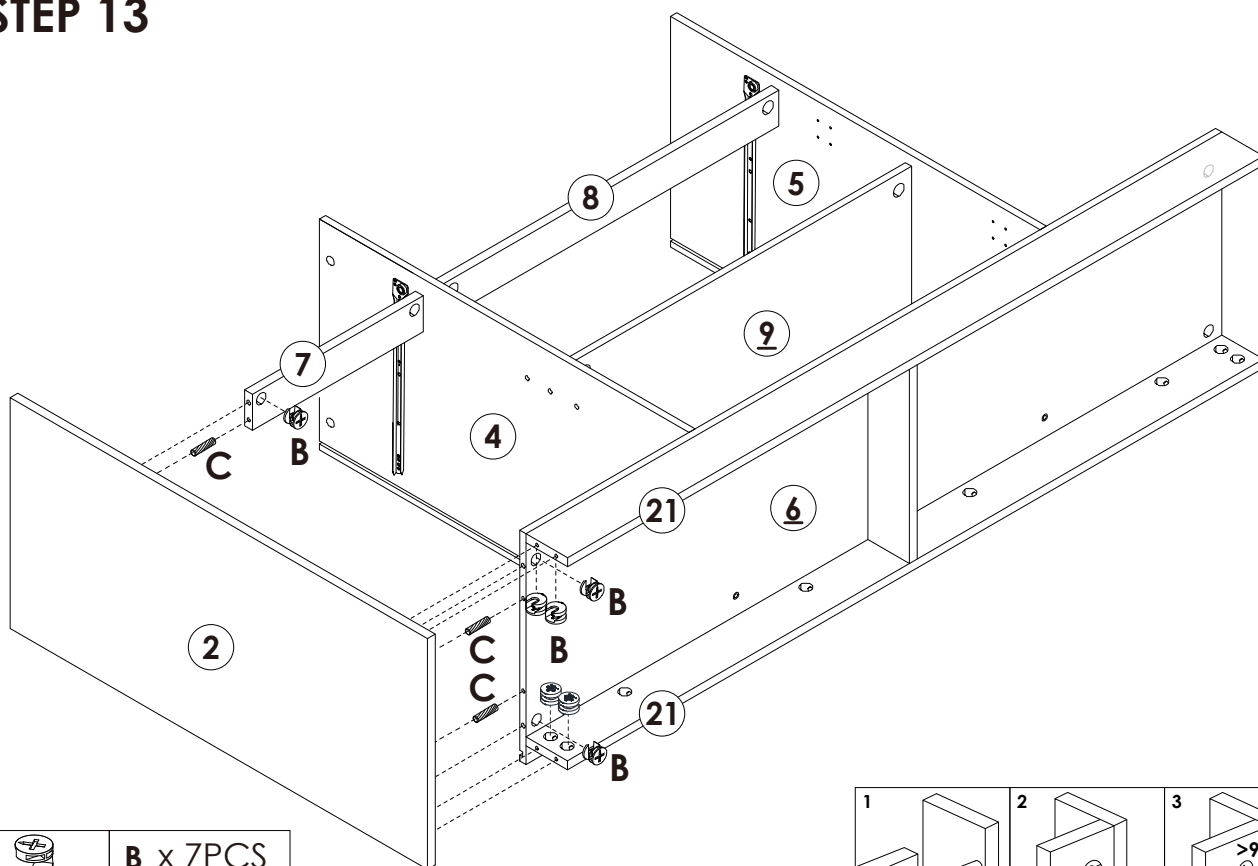

	B x 1PC
	C x 1PC

STEP 13





	B x 7PCS
	C x 3PCS

Assembly Steps(EN) / Montageschritte(DE)

STEP 14

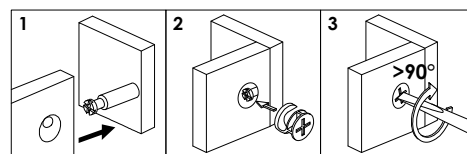
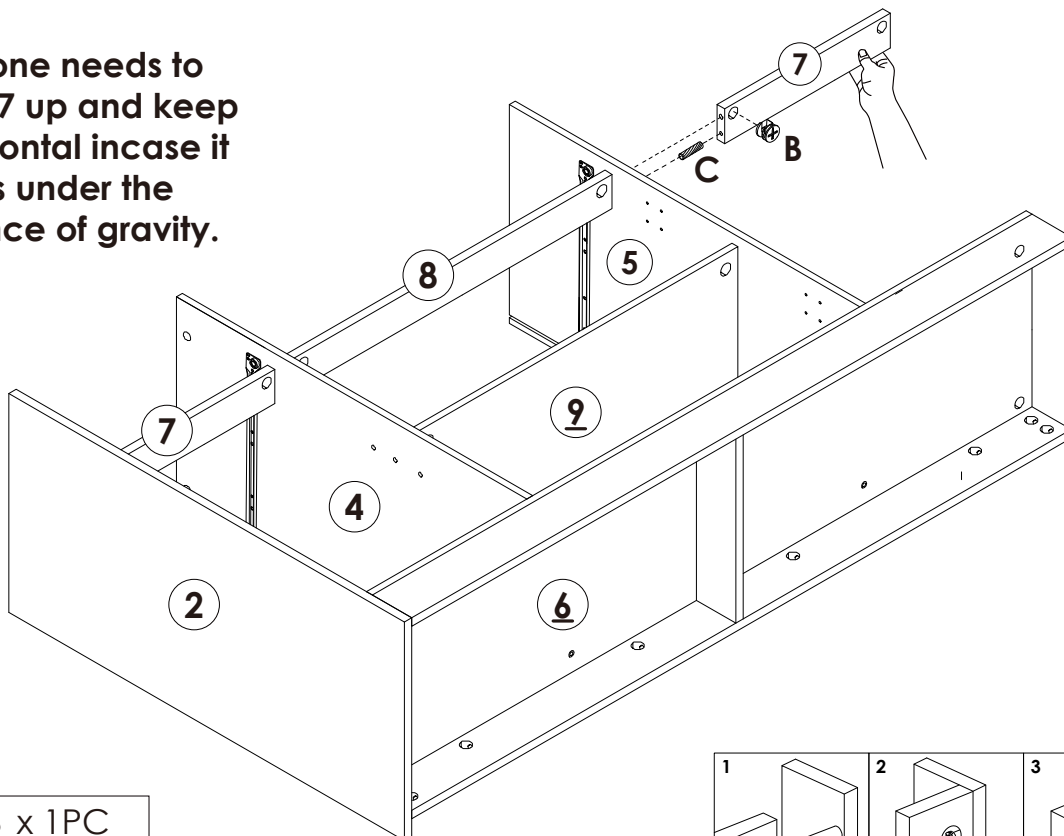

Someone needs to hold #7 up and keep it horizontal incase it breaks under the influence of gravity.

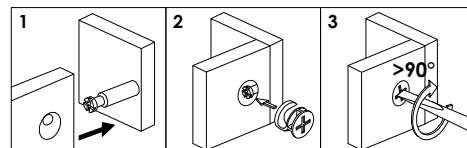
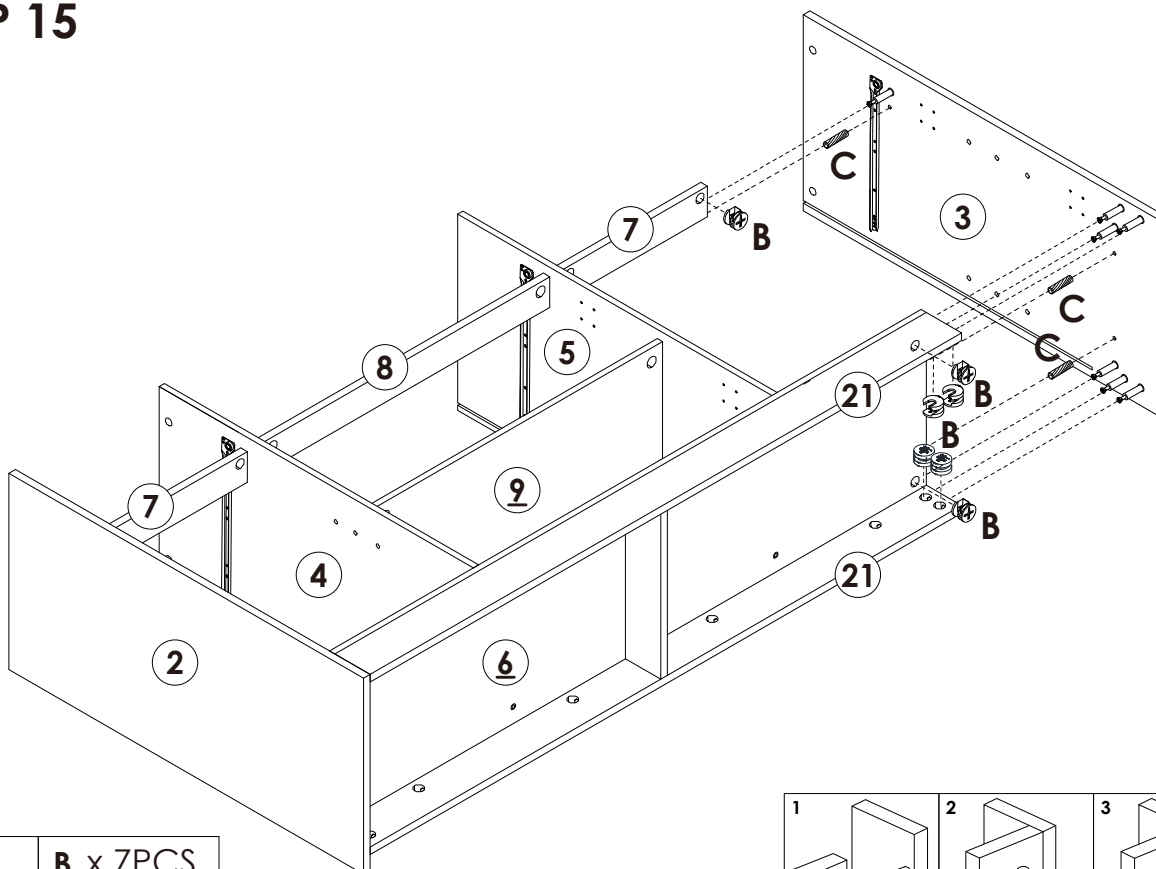

	B x 1PC
	C x 1PC

STEP 15



	B x 7PCS
	C x 3PCS

Assembly Steps(EN) / Montageschritte(DE)

STEP 16

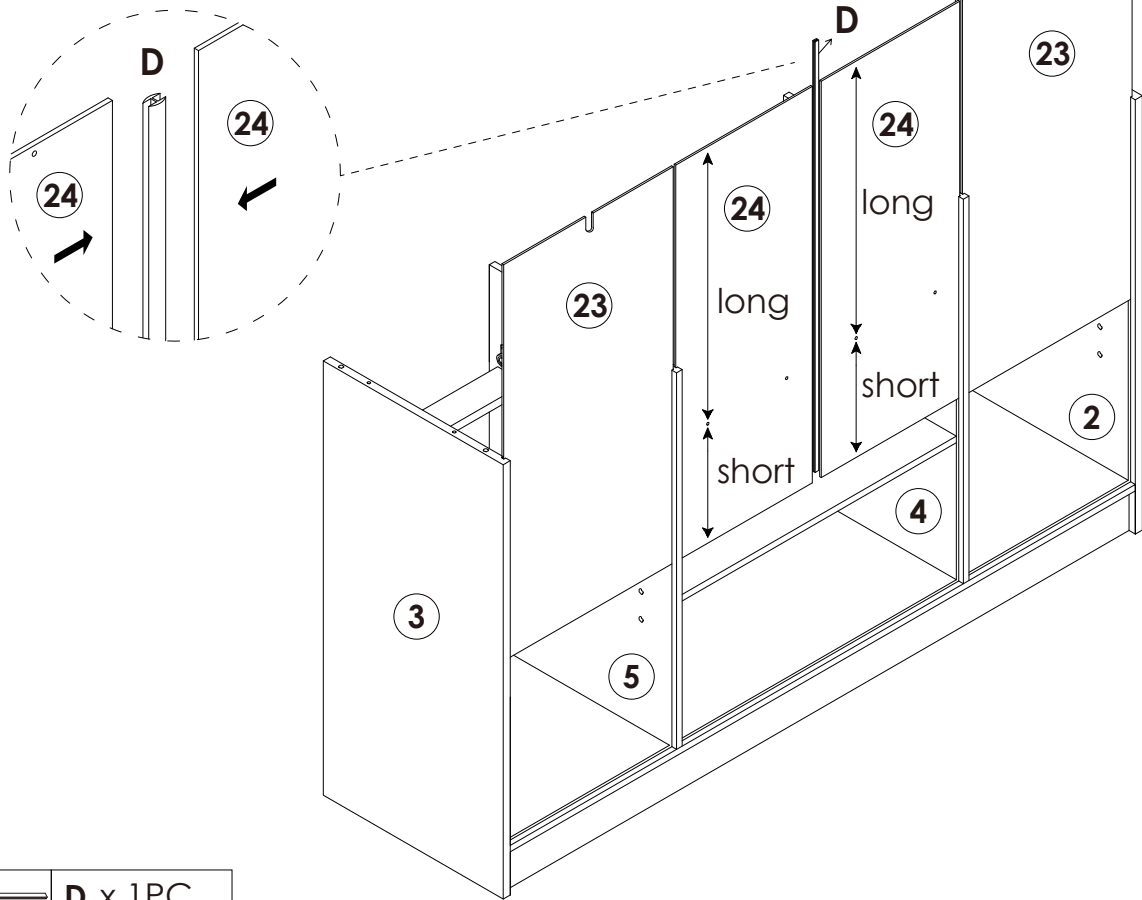



	D x 1PC
---	---------

STEP 17

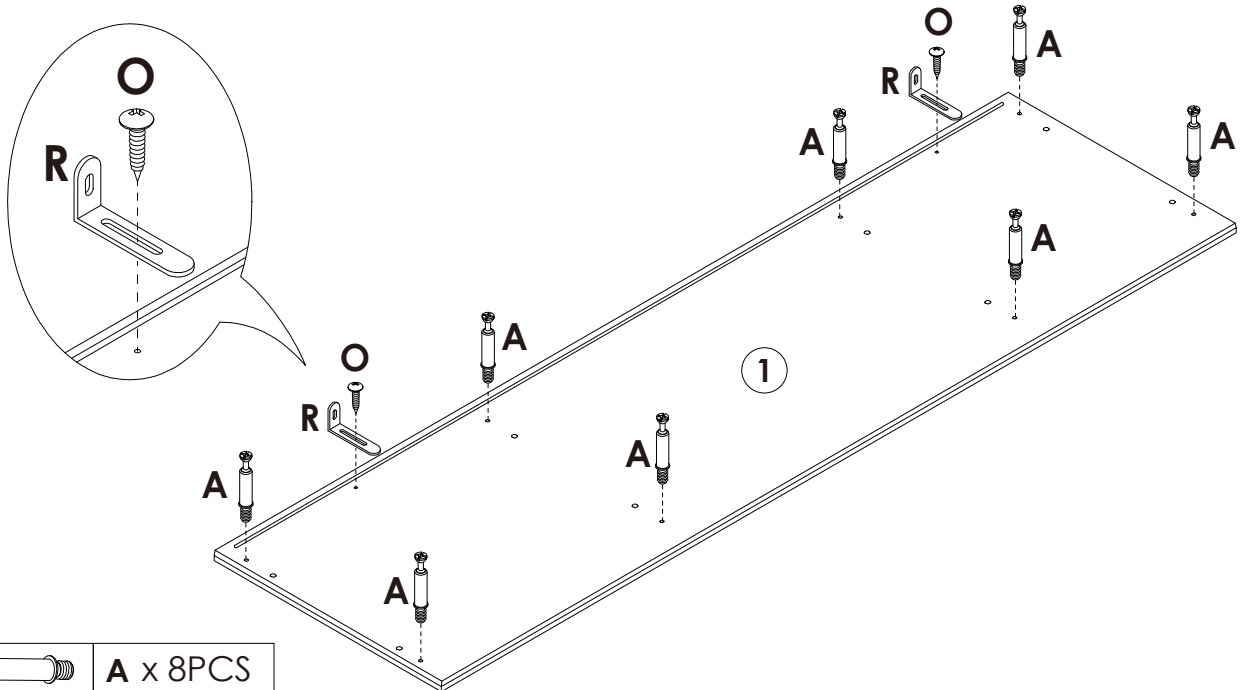
Lock the long side of the "R" L-shaped metal plate to the ① board with the "O" short screw

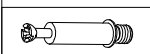
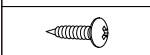



	A x 8PCS
	O x 2PCS
	R x 2PCS

Assembly Steps(EN) / Montageschritte(DE)

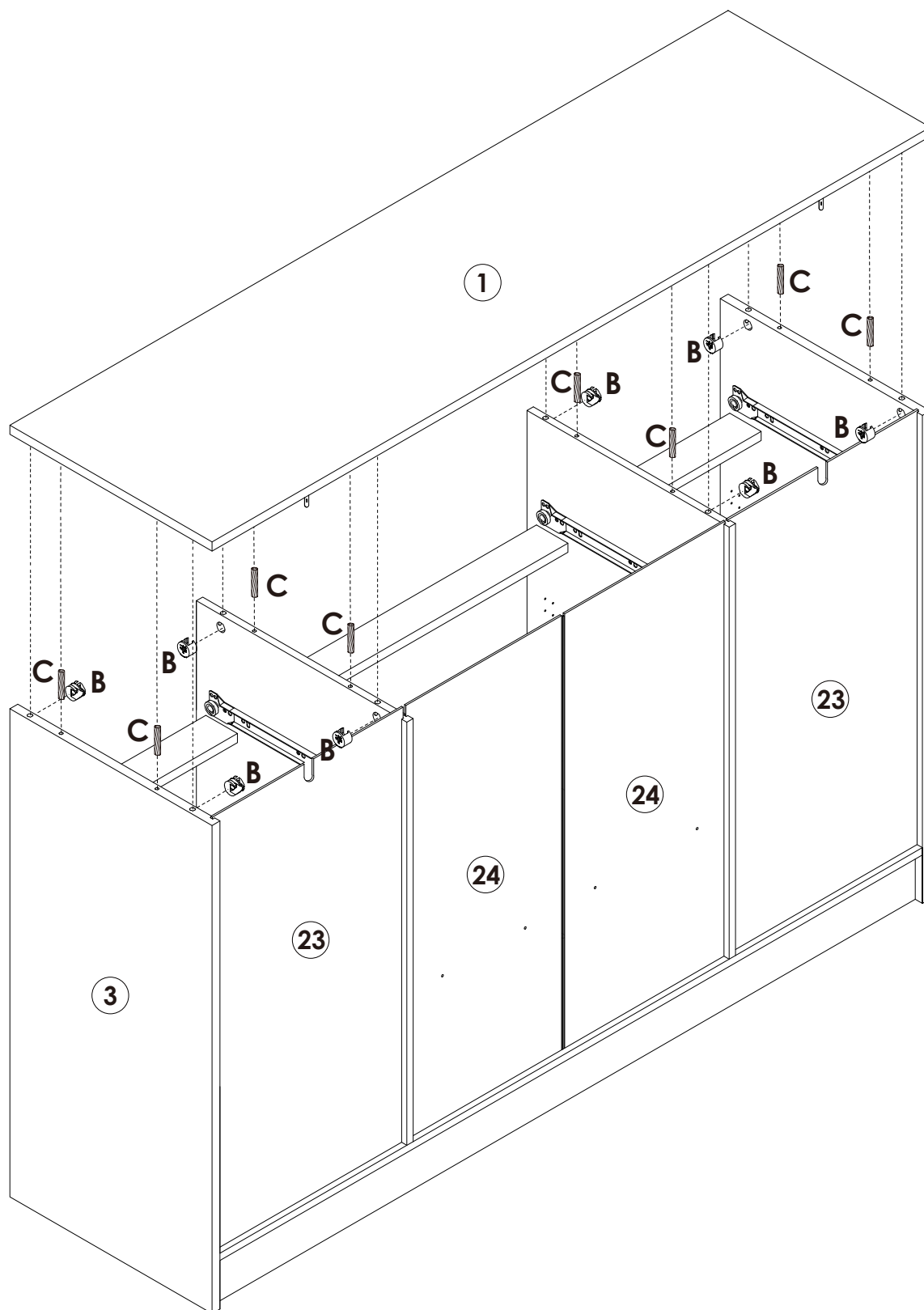
STEP 18



	B x 8PCS
	C x 8PCS

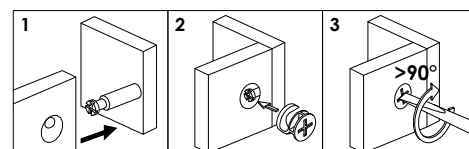

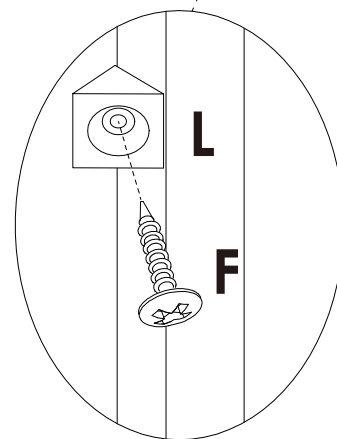
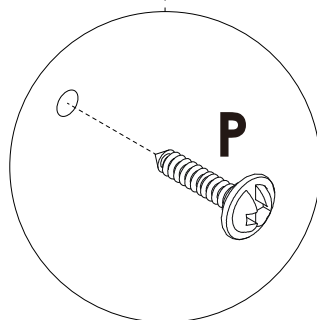
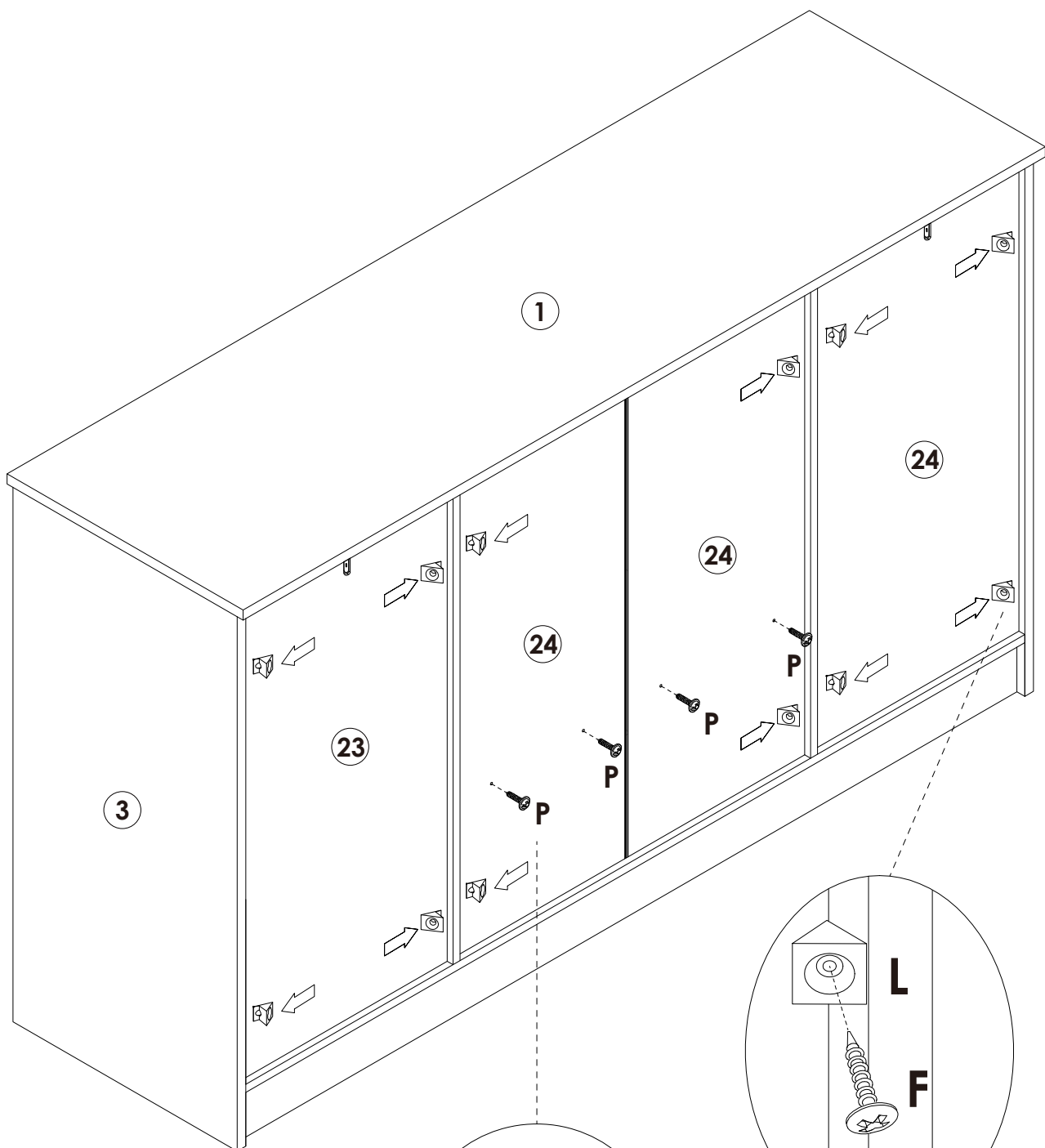

Assembly Steps(EN) / Montageschritte(DE)

STEP 19



x12

	F x 12PCS
	L x 12PCS
	P x 4PCS

Assembly Steps(EN) / Montageschritte(DE)

STEP 20

Drill 2 holes on the wall at the required position for anti-falling device installation.

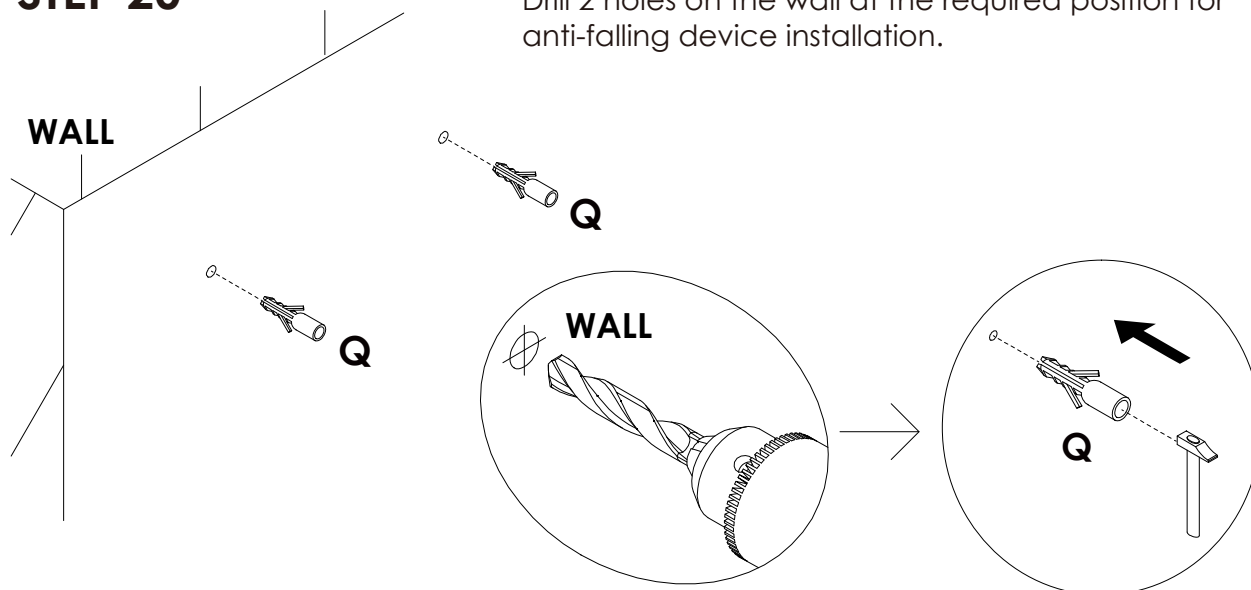

 Q x 2PCS

STEP 21 Move the cabinet to the required position, use the "M" long screw to fix the cabinet to the wall.

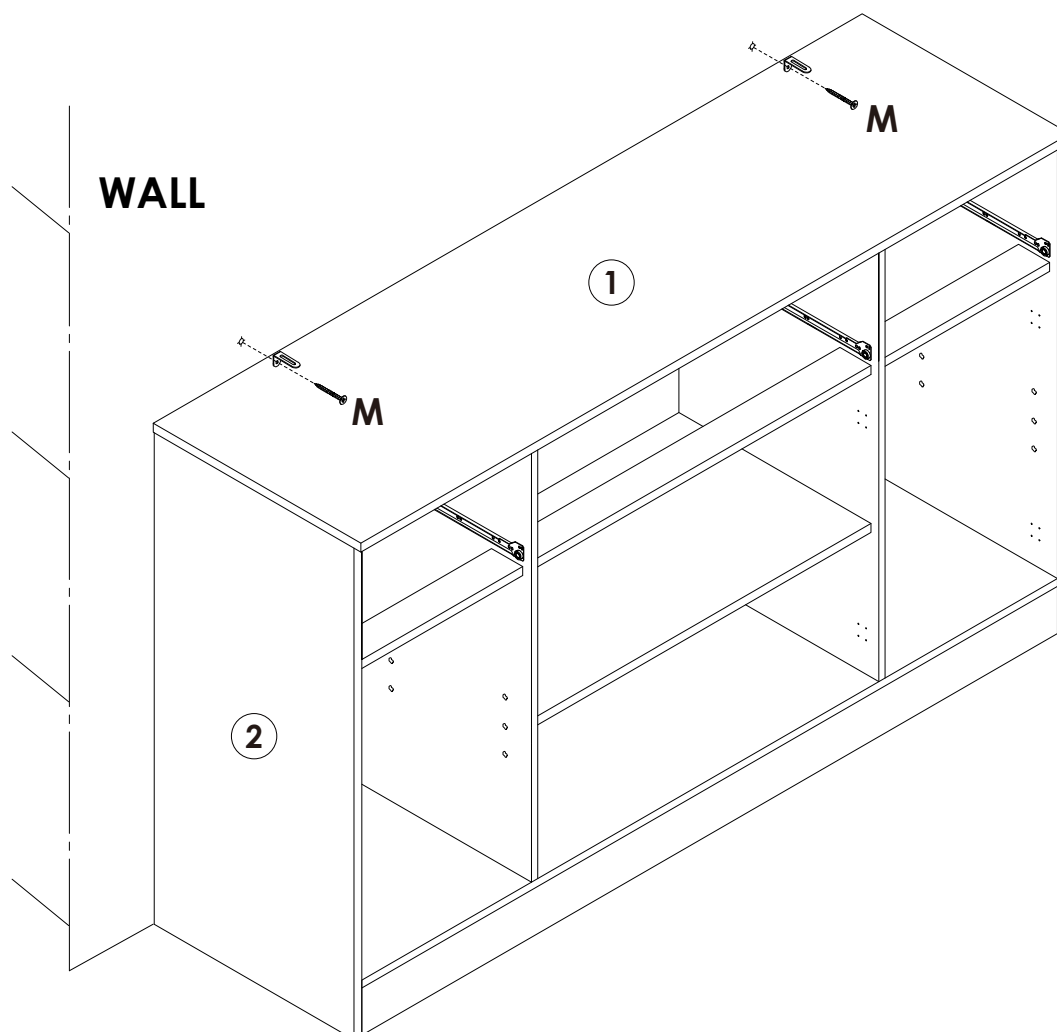

 M x 2PCS

Assembly Steps(EN) / Montageschritte(DE)

STEP 22

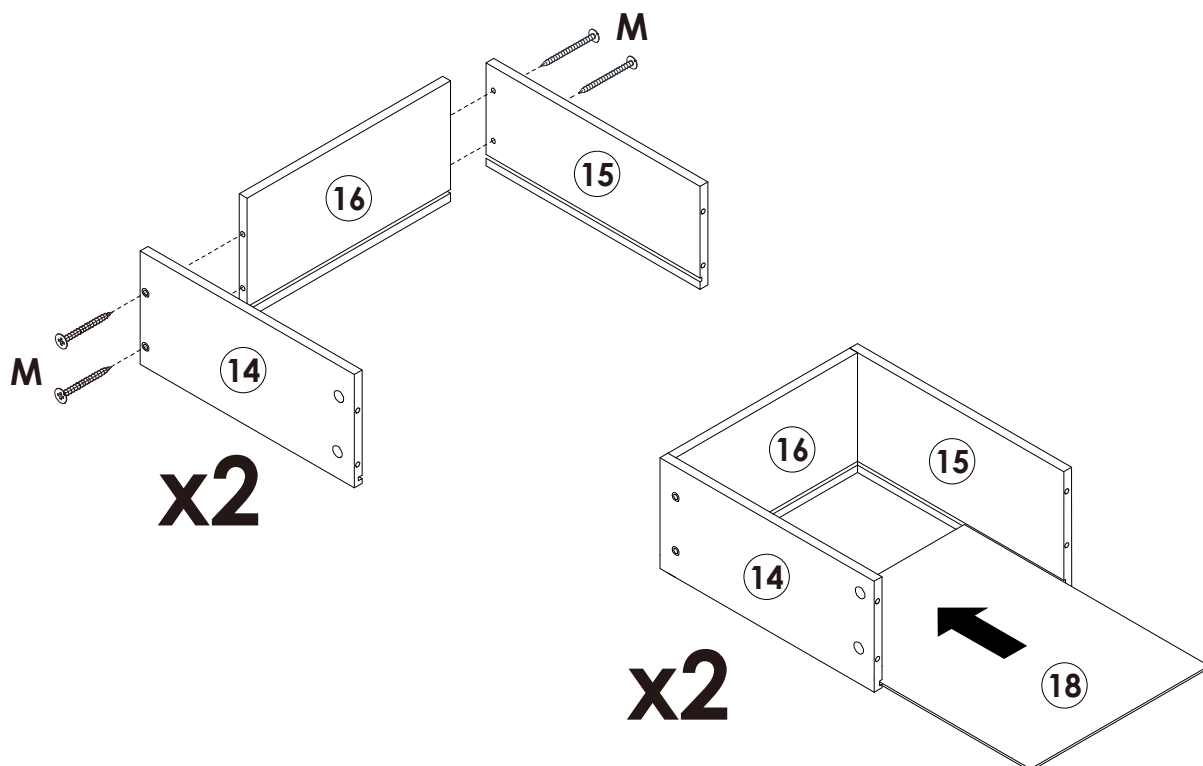

STEP 23

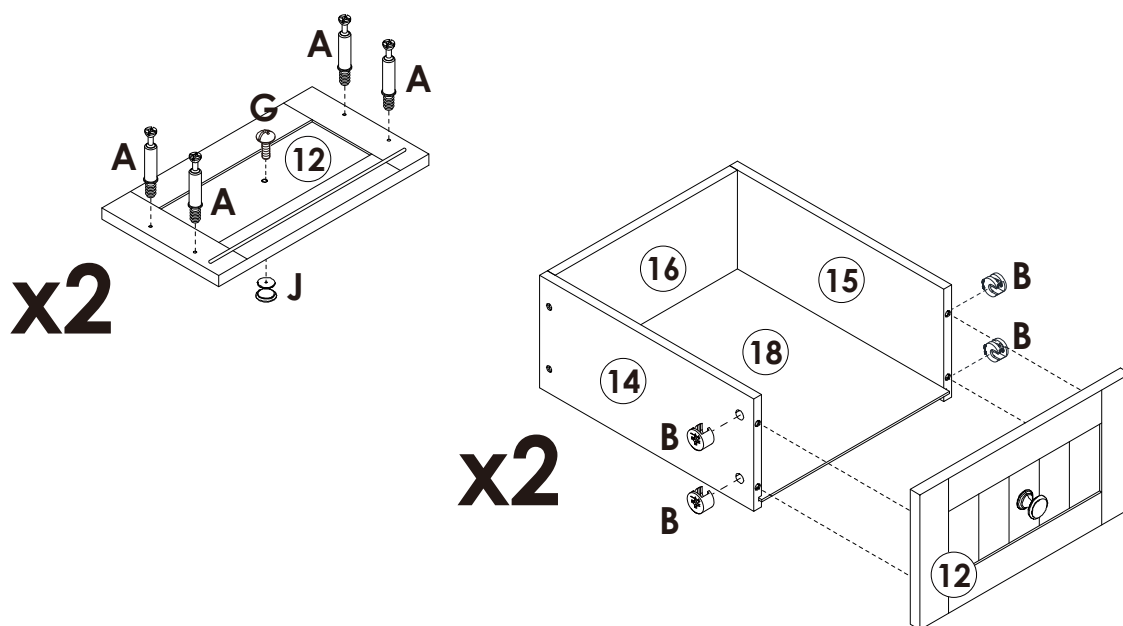

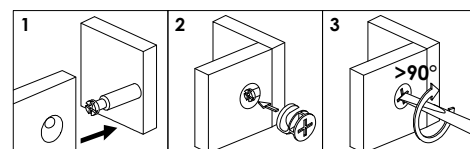

	A x 8PCS
	B x 8PCS
	G x 2PCS
	J x 2PCS

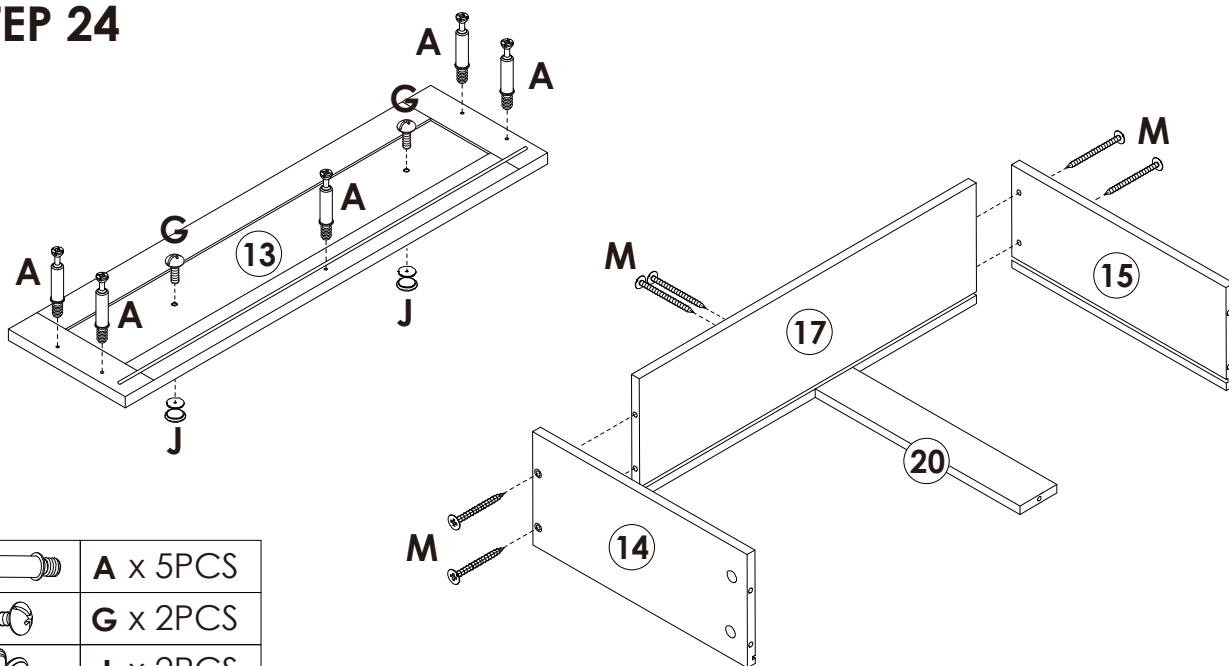

Assembly Steps(EN) / Montageschritte(DE)

STEP 24

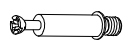

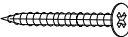
	A x 5PCS
	G x 2PCS
	J x 2PCS
	M x 6PCS

STEP 25

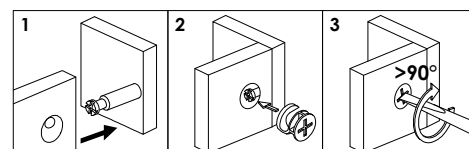
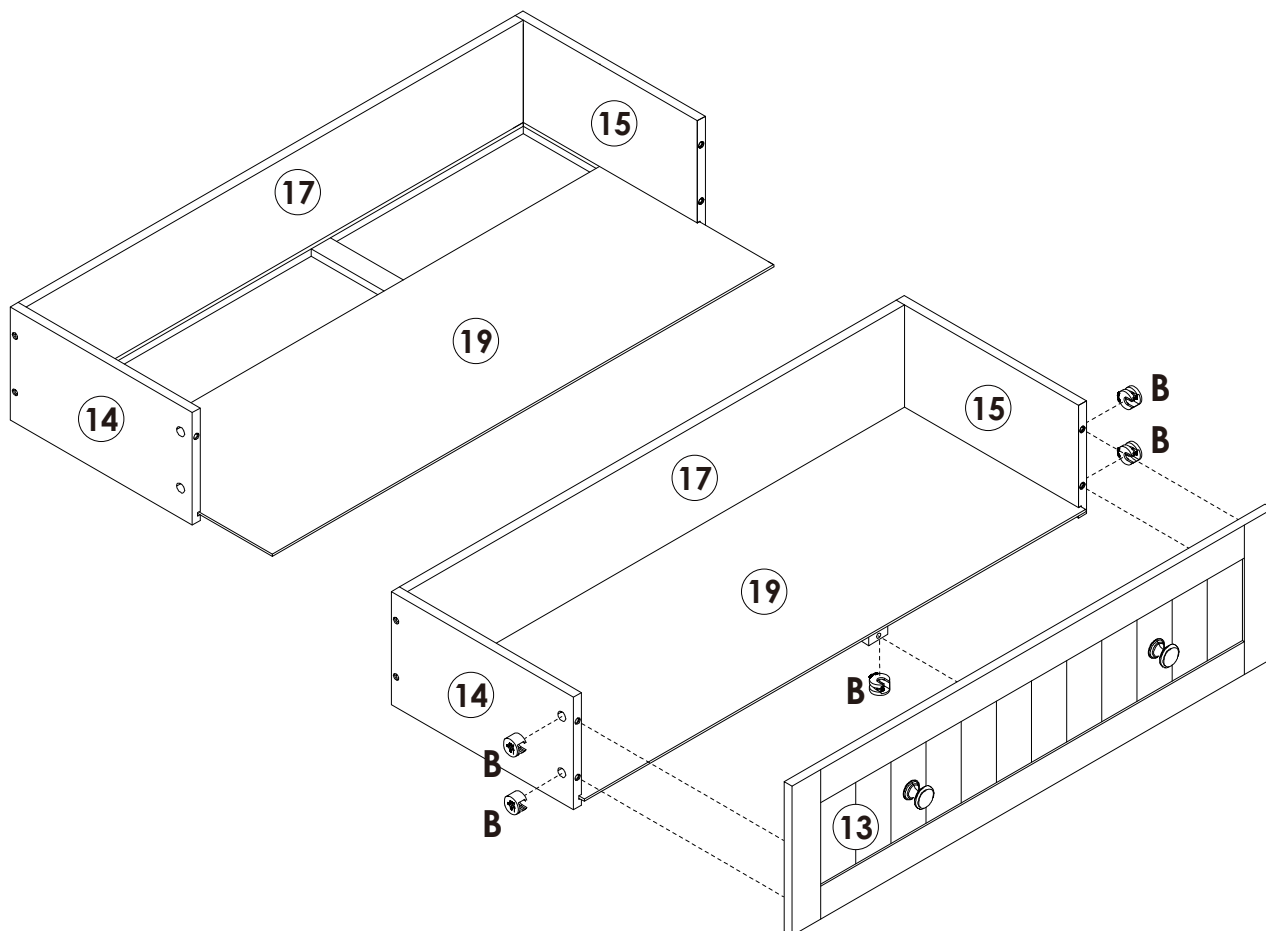



	B x 5PCS
---	----------

Assembly Steps(EN) / Montageschritte(DE)

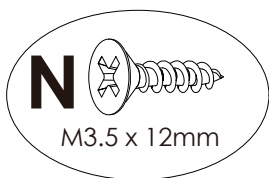
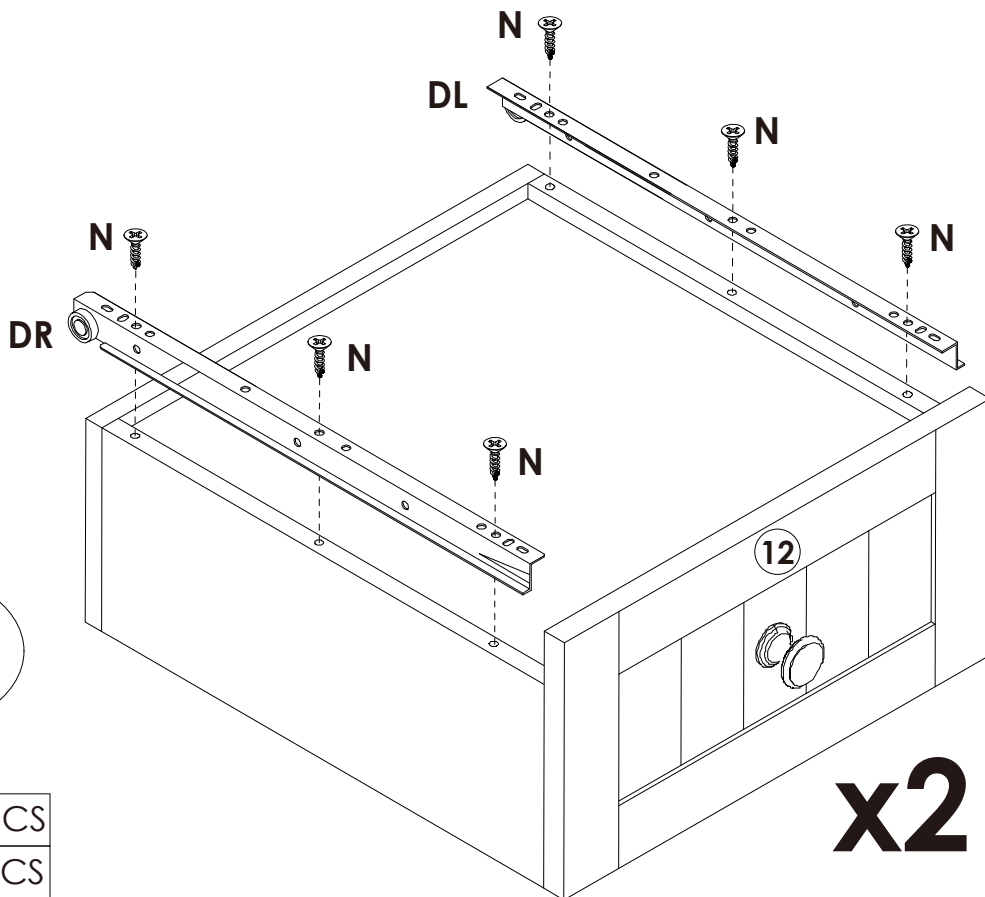
STEP 26





x2

	N x 12PCS
	DL x 2PCS
	DR x 2PCS

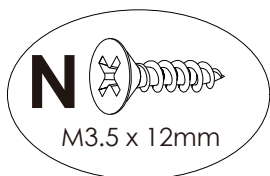
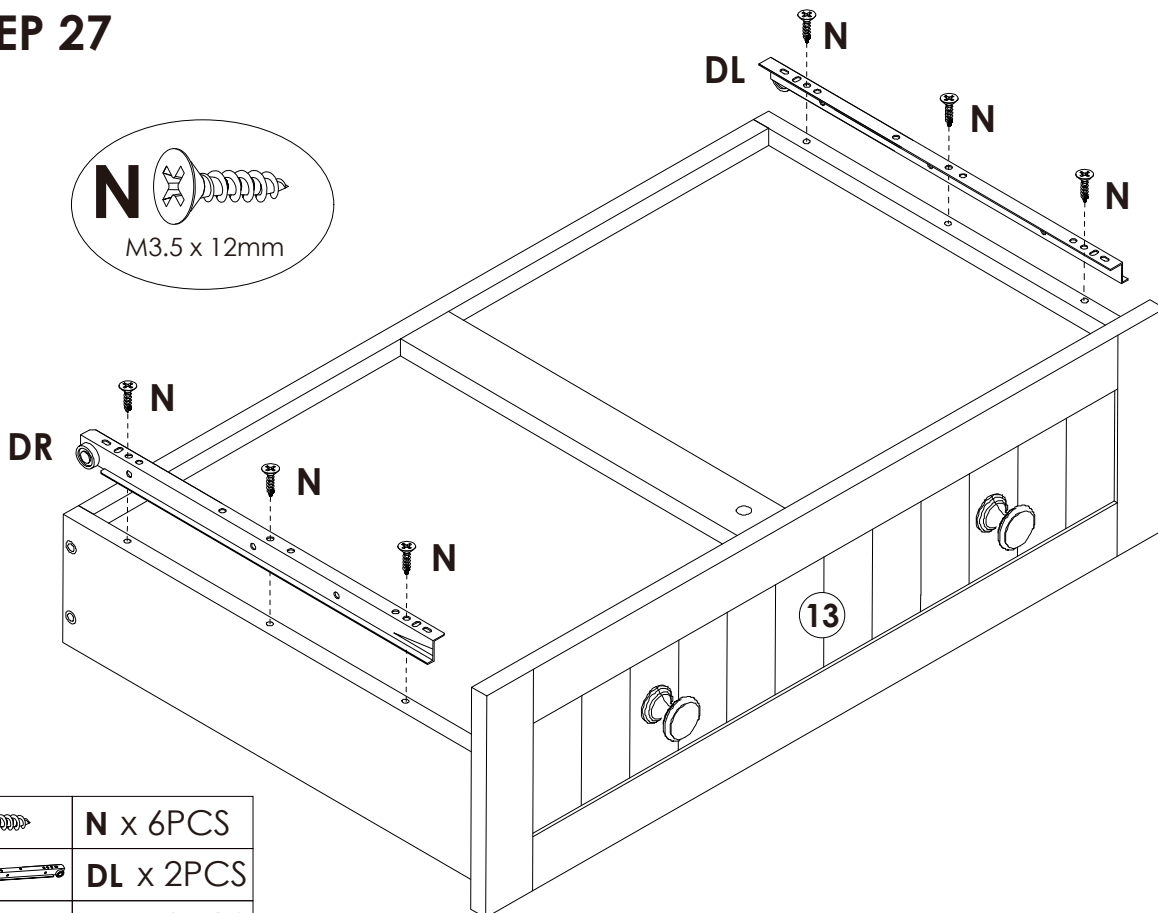
STEP 27



	N x 6PCS
	DL x 2PCS
	DR x 2PCS

STEP 28

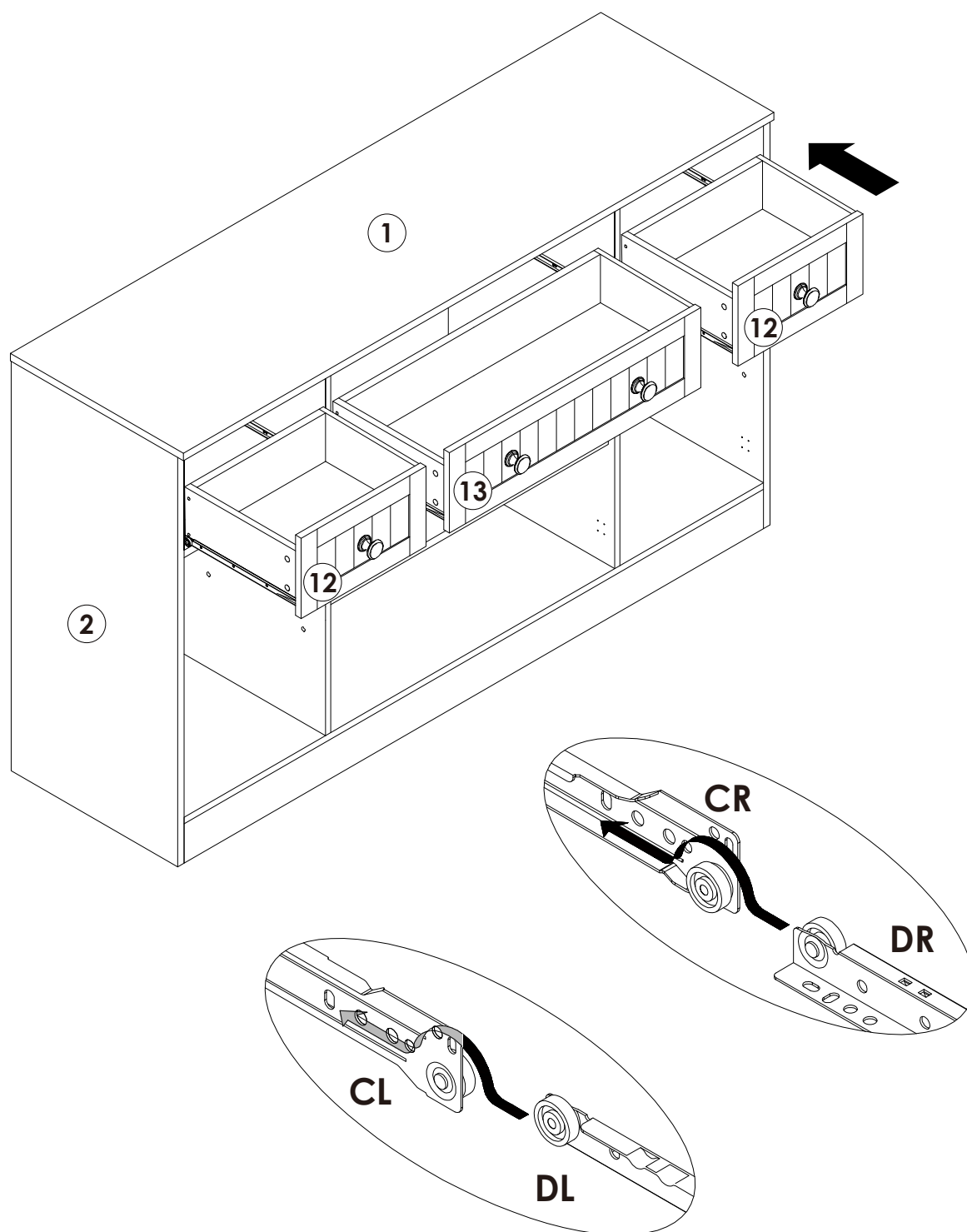

Assembly Steps(EN) / Montageschritte(DE)

STEP 29

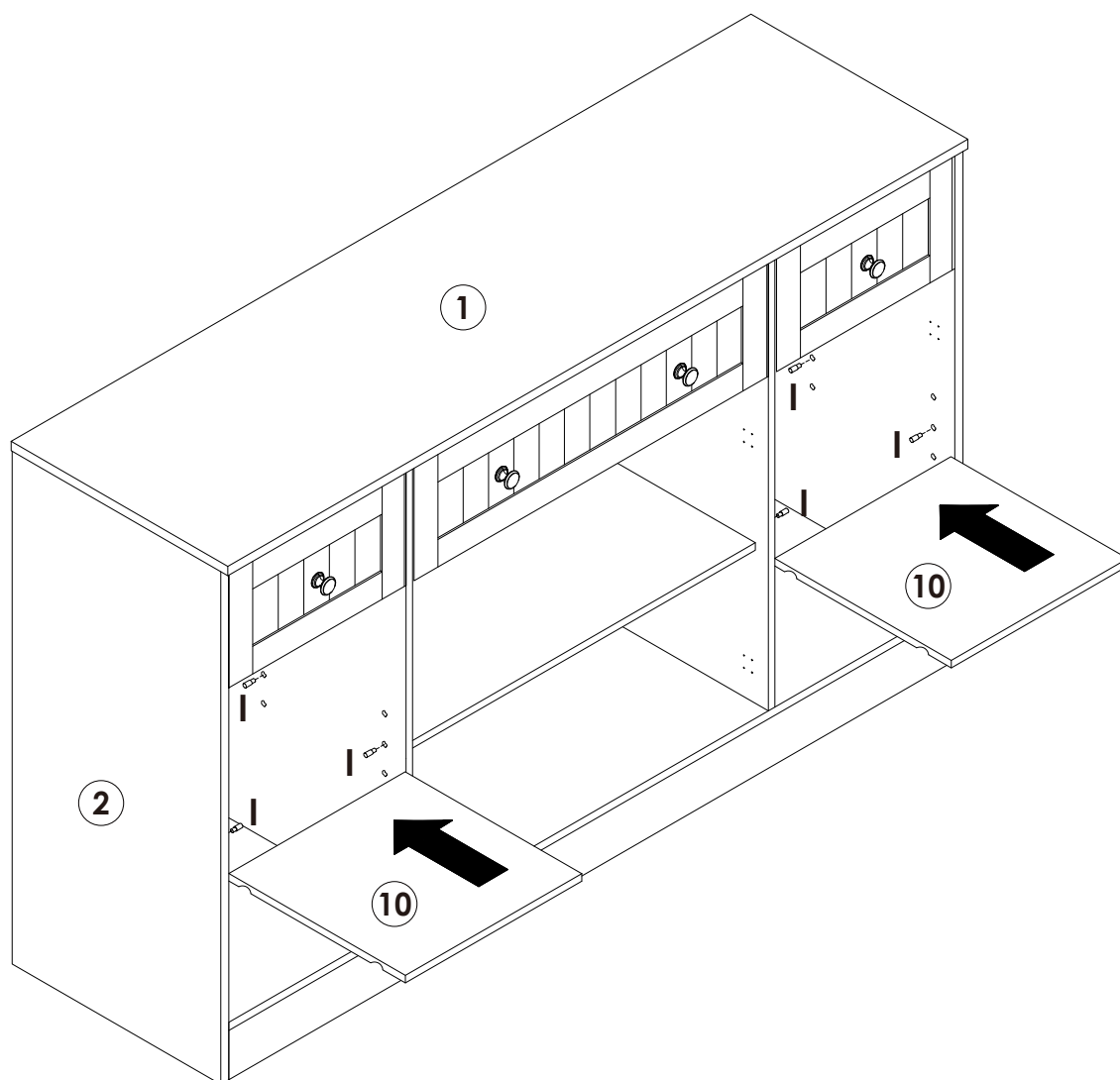

I x 8PCS

Assembly Steps(EN) / Montageschritte(DE)

STEP 30

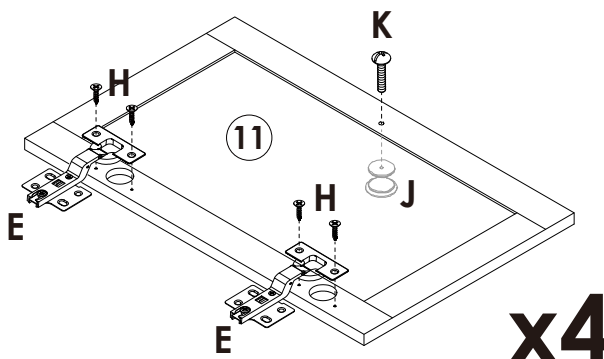
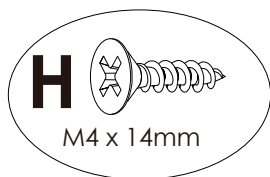

	E x 8PCS
	H x 16PCS
	J x 4PCS
	K x 4PCS

STEP 31

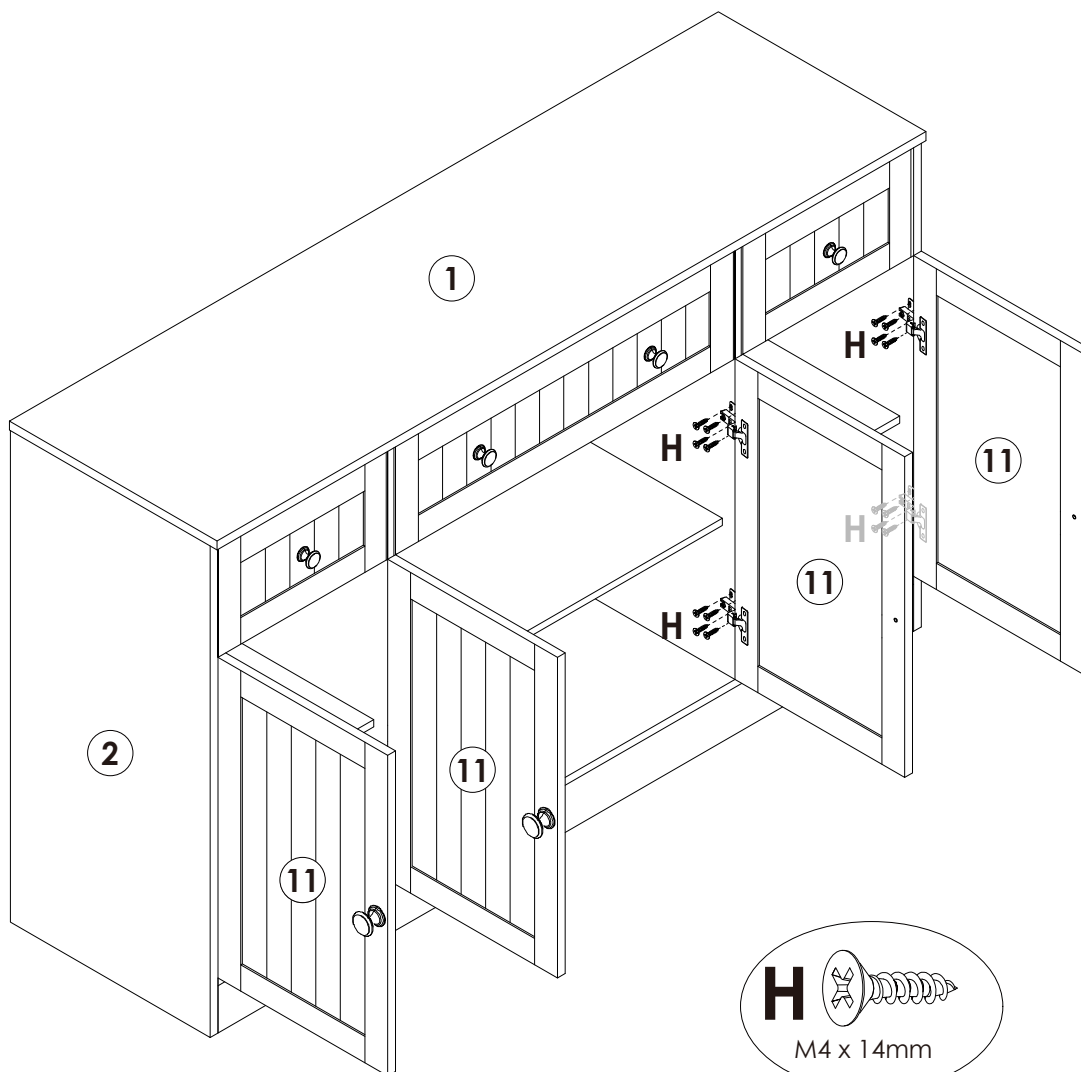

	H x 32PCS
--	------------------



WARNING



Children have died from furniture tipover. To reduce the risk of furniture tipover:

- **ALWAYS** install Anti-tip device provided.
- **NEVER** put a TV on this product.
- **NEVER** allow children to stand, climb or hang on any drawers, doors, or shelves.
- **NEVER** open more than one drawer at a time.
- Place heaviest items in the lowest drawers.



***This is a permanent label.
Do not remove!***